



e-ISSN: 2319-8753 | p-ISSN: 2347-6710

# IJRSET

International Journal of Innovative Research in  
**SCIENCE | ENGINEERING | TECHNOLOGY**

# INTERNATIONAL JOURNAL OF INNOVATIVE RESEARCH

IN SCIENCE | ENGINEERING | TECHNOLOGY

Volume 12, Issue 11, November 2023

**ISSN** INTERNATIONAL  
STANDARD  
SERIAL  
NUMBER  
INDIA

Impact Factor: 8.423

9940 572 462

6381 907 438

[ijirset@gmail.com](mailto:ijirset@gmail.com)

[www.ijirset.com](http://www.ijirset.com)

# Robotic Contaminant Separation from Wet Sand: Pioneering Technological Advancements in Environmental Remediation.

<sup>1</sup>Rakshak Sood, <sup>2</sup>Farhan Khan, <sup>3</sup>Aditya Singh, <sup>4</sup>Gourang Gadgil, <sup>5</sup>Komal Tambe

<sup>1</sup>Assistant Professor, Department of Electronics and Computer Science, Vidyalankar Institute of Technology, Mumbai, India

<sup>2</sup>Student, Department of Electronics and Computer Science, Vidyalankar Institute of Technology, Mumbai, India

<sup>3</sup>Student, Department of Electronics and Computer Science, Vidyalankar Institute of Technology, Mumbai, India

<sup>4</sup>Student, Department of Electronics and Computer Science, Vidyalankar Institute of Technology, Mumbai, India

<sup>5</sup>Student, Department of Electronics and Computer Science, Vidyalankar Institute of Technology, Mumbai, India

**ABSTRACT:** This research addresses the pressing issue of plastic waste accumulation in wet sand environments along coastlines. The project focuses on the design, development, and implementation of an innovative excavator-based system with an integrated sorting mechanism. The primary objective is to achieve precise and efficient removal of plastic waste from damp coastal areas, while minimizing ecological disturbances and maximizing resource utilization. The proposed solution not only streamlines the beach cleaning process but also significantly reduces the investment of time and resources required. The excavator-based system is specifically engineered to operate effectively in challenging conditions characterized by the high strength of wet sand. By offering an energy-efficient alternative, this solution presents a promising approach to alleviating the environmental hazards posed by plastic waste accumulation in these critical coastal ecosystems.

**KEYWORDS:** PLASTIC WASTE, WET SAND ENVIRONMENTS, COASTAL ECOSYSTEMS, EXCAVATOR-BASED SYSTEM, INTEGRATED SORTING MECHANISM, BEACH CLEANING, ECOLOGICAL DISTURBANCES, RESOURCE UTILIZATION, ENVIRONMENTAL HAZARDS.

## I.INTRODUCTION

Coastal environments represent invaluable ecological niches, sustaining a rich tapestry of biodiversity and providing essential services to both wildlife and human communities alike. However, the alarming accumulation of plastic waste, particularly in the damp sands along coastlines, poses an escalating threat to these delicate ecosystems. Addressing this challenge necessitates the development of innovative solutions that not only exhibit precision in plastic waste removal but also minimize ecological disturbances while maximizing resource utilization. In response to this pressing need, our research endeavours to pioneer a transformative approach through the design, development, and implementation of an advanced excavator-based system bolstered by an integrated sorting mechanism. Tailored to navigate the formidable challenges posed by wet sand, where traditional methodologies often prove inadequate due to the material's inherent tenacity, our solution represents a paradigm shift in beach cleaning technology. By introducing this cutting-edge system, we aim to significantly augment the efficiency and effectiveness of beach cleaning endeavours, ultimately curbing the environmental perils wrought by plastic waste accumulation in coastal ecosystems. This paper provides a comprehensive exposition of the conceptualization, engineering, and potential ramifications of this groundbreaking solution.

## **II. LITERATURE SURVEY**

### **REVIEW-1:**

The development of efficient beach cleaning machines has been a subject of ongoing research and innovation, driven by the need to combat the increasing accumulation of debris along coastlines. In the paper titled "Manufacturing of Beach Cleaning Machine at UMS Prototype Design and Analysis" by N. Bolong, I. Saad, and M. Amran Madan (2021), the authors present a noteworthy contribution in this field. The paper focuses on the integration of both raking and sifting mechanisms in a beach cleaner, employing a sprocket chain arrangement with key components including a collector, conveyor, motor, and gears. This design represents a significant step towards creating a comprehensive and efficient beach cleaning solution. One of the primary objectives outlined in the paper is the fabrication of a user-friendly beach cleaning machine that can be operated by a single individual. This emphasis on simplicity and cost-effectiveness is a crucial consideration, as it enables broader accessibility and utilization of the technology. The manual operation of the prototype, as described in the paper, provides a foundation for further improvements. The authors acknowledge this by incorporating additional features aimed at enhancing user feasibility. Notably, the integration of live surveillance and remote automated operation represents a substantial advancement in the functionality of the beach cleaning machine. This work builds upon a body of literature dedicated to the development of beach cleaning technologies. Previous studies have explored various mechanisms and designs, ranging from mechanical raking systems to advanced automated solutions. The incorporation of both raking and sifting mechanisms in the UMS prototype demonstrates a holistic approach to debris removal. Moreover, the emphasis on user feedback through on-site testing and surveys underscores the importance of user-centric design in the development of such machinery. This aligns with broader trends in engineering and design, where user experience and feedback play a pivotal role in refining and optimizing technological solutions. In conclusion, the paper by Bolong, Saad, and Madlan presents a significant contribution to the field of beach cleaning machine development. The integration of raking and sifting mechanisms, coupled with the emphasis on user-friendliness and cost-effectiveness, represents a commendable effort in addressing the environmental challenges posed by coastal debris accumulation. The incorporation of additional features such as live surveillance and remote automated operation further augments the practicality and effectiveness of the prototype. This work contributes to a growing body of literature focused on advancing beach cleaning technologies, with potential implications for coastal conservation and environmental sustainability.

### **REVIEW-2:**

The paper titled "Design and Analysis of Sustainable Beach Cleaner" by H. Ebrahim, W. Sheikh, and A. Saeed (2022) provides a comprehensive exploration of beach cleaner projects, with the overarching goal of addressing their inherent limitations. The authors embark on a meticulous examination of existing beach cleaner initiatives, demonstrating a commitment to refining and enhancing the technology. This proactive approach underscores the importance of continuous improvement and innovation in the field of coastal debris management. A notable contribution of this paper lies in the detailed study of the functionality of beach cleaners, complemented by the presentation of motion and stress graphs. This analytical approach adds a valuable dimension to the evaluation of beach cleaning machines, enabling a deeper understanding of their operational dynamics. The design of the machine described in the paper is a testament to the authors' adept synthesis of various features gleaned from their research. Central to its mechanism is a straightforward yet effective chain sprocket arrangement. In this setup, the sprocket impels the chain, while the rakes affixed to it hoist the debris. This design choice embodies an elegant simplicity, aligning with the principle of sustainability by minimizing complexity and resource consumption. The authors transparently acknowledge limitations encountered during the development of their prototype. Specifically, challenges related to the consistent collection of small debris and the potential retrieval of unintended obstacles are identified. However, the incorporation of a mesh component in the prototype represents a significant improvement, enabling the capture of finer debris with enhanced precision. Moreover, the integration of live surveillance introduces a dynamic element to the operation of the beach cleaner. This technological augmentation empowers the operator to exercise real-time discretion, avoiding the inadvertent retrieval of non-debris obstructions. This feature significantly enhances the efficiency and accuracy of the cleaning process, exemplifying a user-centric design approach. In conclusion, the paper by Ebrahim, Sheikh, and Saeed offers a commendable contribution to the advancement of beach cleaning technology. Through a thorough analysis of existing projects and a meticulous study of functionality, the authors demonstrate a commitment to overcoming

limitations in coastal debris management. The design of their sustainable beach cleaner, characterized by a straightforward chain sprocket arrangement, exemplifies an elegant and resource-conscious engineering solution. The incorporation of a mesh component and live surveillance further underscore the authors' dedication to refining and optimizing their prototype. This work not only adds to the body of knowledge in beach cleaner development but also holds promise for practical applications in coastal conservation and environmental sustainability efforts.

In addition to the substantial advancements achieved in beach cleaning technology, it is crucial to acknowledge a persistent challenge that remains unaddressed in the existing literature. The majority of the projects examined in this survey primarily focus on the cleaning of dry sand environments. The unique complexities posed by wet sand, characterized by its high cohesive strength, present a distinct set of challenges that necessitate specialized solutions. While the prototypes discussed in this paper represent significant strides towards more effective and sustainable beach cleaning, further research and innovation are urgently needed to develop systems capable of efficiently and accurately removing debris from wet sand areas. This unmet need underscores the ongoing importance of advancing beach cleaning technology to comprehensively address the diverse range of environmental conditions encountered along coastlines. By addressing this critical gap, future advancements in beach cleaning technology have the potential to significantly enhance the preservation of coastal ecosystems and mitigate the environmental impact of debris accumulation in both wet and dry sand environments

### III. METHODOLOGY

The project involves an excavator equipped with a belt and roller mechanism to collect wet sand. This collected sand is then directed into a rapidly rotating cylinder, where the high-speed rotation facilitates the drying process. This innovative system provides an efficient method for processing wet sand, allowing for its potential disposal in a more environmentally friendly manner.

#### BLOCK DIAGRAM:

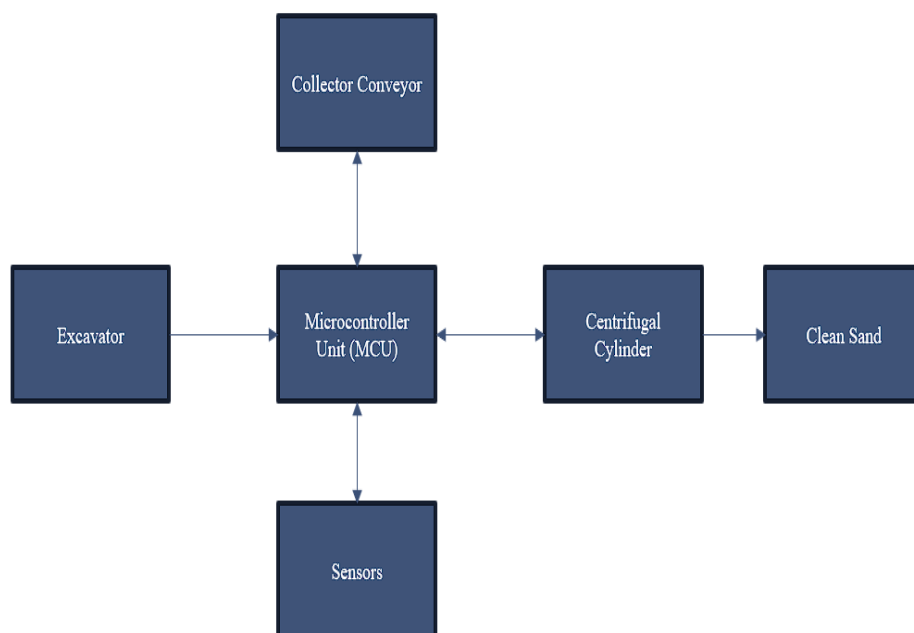



**3.1 HARDWARE USED:**

Motor Requirements		Electronic Components		Other Parts	
Motor Specs	Quantity			Motor Specs	Quantity
Conveyor Motor	1	ESP32	2	MS Cylinder	1
Cylinder Motor	1	Motor Driver Circuit		Acrylic Chasis	1
Movement Motor	4	Wires		Conveyor Belt	4
Conveyor Collector Motor	1	Humidity sensor	1	Roller Conveyor	
		battery 12V 7 Ah	1		

**3.2 SOFTWARE USED :**

- **Arduino IDE :-** It's a compact programming tool enabling you to write and upload your code to the Arduino board. Packed with user-friendly built-in features, it's easy to understand and use. Plus, it comes at no cost, making it highly accessible.
- **Siemens Nx:-** NX, developed by Siemens Digital Industries Software, is a comprehensive computer-aided design (CAD), computer-aided manufacturing (CAM), and computer-aided engineering (CAE) software platform. It is widely used in industries such as automotive, aerospace, manufacturing, and engineering for product design, engineering analysis, and manufacturing process planning.

**3.3 CAD DESIGN :**

- The model is designed on CAD software Siemens Nx with proper dimensions as shown below.

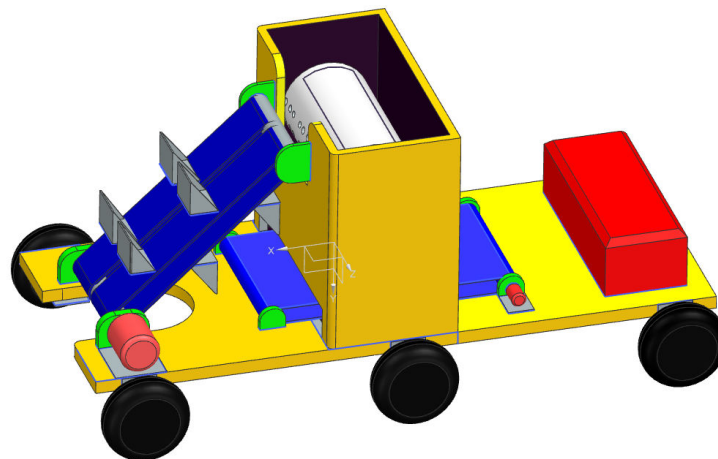

**3.4 CENTRIFUGAL DRYING MECHANISM**

- This crucial tool employs centrifugal force to facilitate the drying of wet sand. Through a controlled rotation over a specified duration, the mechanism efficiently separates water from the sand. As a result, the water and sand mixture is displaced through designated holes, leaving behind only waste material in the cylinder. This innovative approach streamlines the process of drying wet sand, offering a more efficient and environmentally sustainable solution.

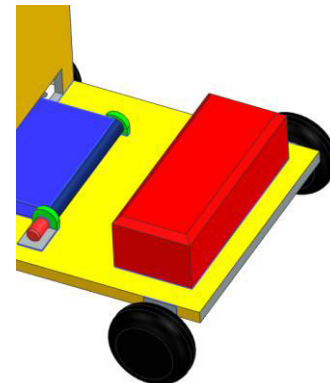
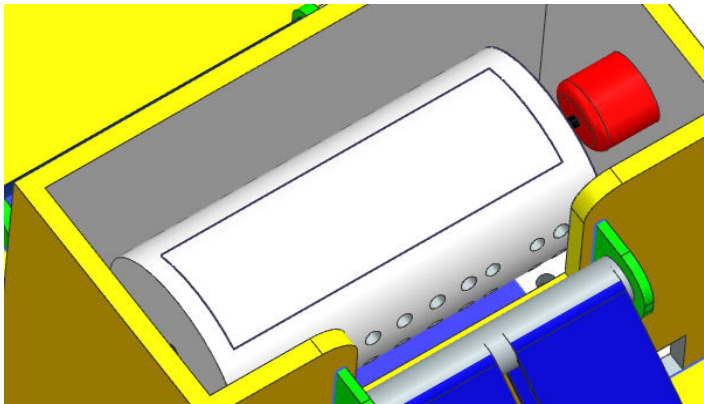

#### IV.WORKING

Picture a clever robot cruising along the coastline, scooping up wet sand for processing. It's equipped with a handy ultrasonic sensor to steer clear of any big obstacles. This nifty combination of features makes it a game-changer in keeping our shores clean and tidy! The project involves a multi-step process for efficiently managing wet sand on coastlines. The excavator is equipped with specialized equipment for excavating wet sand directly from the ground. This excavated wet sand is then directed towards the centrifugal drying mechanism. Upon arrival at the centrifugal drying mechanism, the wet sand is propelled into the mechanism. At this point, the centrifugal door promptly closes, securing the sand within the cylindrical chamber. The key operational phase commences with the high-speed rotation of the cylinder, achieving an impressive rotational speed of approximately 1000 revolutions per minute (rpm). The high-speed rotation induces a centrifugal force, effectively expelling water from the wet sand. As a result, the sand undergoes a drying process within the confined space of the cylinder. This operation continues until a specific threshold is reached, indicating that the sand has achieved the desired level of dryness. At this critical juncture, the dried sand is expelled through strategically positioned small perforations in the cylinder body. However, it is imperative to note that the drying process also results in the accumulation of debris within the cylinder module. To address this, the cylinder is repositioned, with its orientation now at the bottom side. This adjustment facilitates the controlled release of the accumulated debris. The operational door is unsealed, allowing the debris to descend onto a precisely engineered conveyor tray. This tray is specially designed to efficiently collect and transport the debris to a designated area, ensuring a seamless transition for subsequent processing.

This meticulously designed operational sequence ensures a continuous and efficient process for excavating, drying, and managing wet sand and debris along coastlines, demonstrating a sophisticated level of technical precision and engineering expertise.

#### 4.1 ELECTRONIC SIMULATION & CALCULATION:

This project features a cutting-edge electronics simulation, employing advanced hardware components driven by the powerful ESP32 microcontroller. Three crucial motor-driven subsystems play pivotal roles in managing wet sand along coastlines. The first motor, guided by an ESP32-controlled driver, operates the excavator for precise sand collection. The second motor, regulated by another ESP32-driven driver, powers the centrifugal drying mechanism, achieving impressive speeds of 1000 rpm. The third motor, also controlled by an ESP32-powered driver, drives the collector conveyor for efficient debris collection. The ESP32 acts as the central intelligence hub, coordinating motor operation for optimal performance. Components are in R&D, reflecting the project's commitment to ongoing improvement. The attached circuit diagram illustrates the intricate interconnection of ESP32, motor drivers, and motors, showcasing the system's comprehensive design.

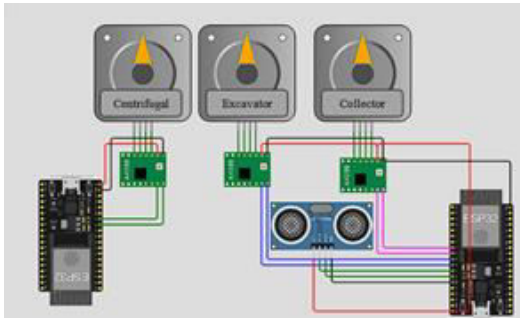

(Figure 1, Electronics simulation)

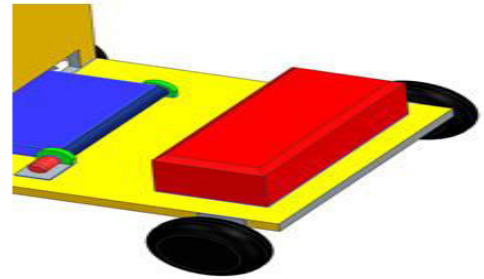

(Figure 2, Electronics assembly)

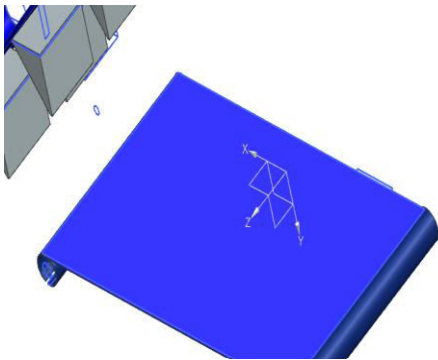

(Figure 3, collector conveyor)

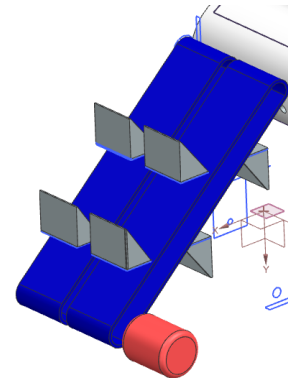

(Figure 4, the excavator mechanism)

## 4.2 Excavator Motor Specification Calculation

### Scenario:

Excavating 500 grams of wet sand from the sea floor and lifting it to a height of 120 cm at a 45-degree angle using a conveyor belt.

**Motor speed:** 20 RPM.

### Calculations:

#### Force Required to Lift the Wet Sand:

Weight of wet sand (m) = 0.5 kg

Acceleration due to gravity (g) = 9.81 m/s<sup>2</sup>

Force (F) = m \* g ≈ 4.91 N

#### Work Done per Unit Time (Power):

Total distance (d) =  $\sqrt{(1 \text{ m})^2 + (1.2 \text{ m})^2} \approx 1.562 \text{ m}$

Power (P) = (F \* d \* RPM) / 60 ≈ 16.37 W

#### Accounting for System Efficiency (80%):

Input Power (P<sub>input</sub>) = P / Efficiency ≈ 20.46 W

**Converting to kilogram-force centimeters (kgf·cm):**

20.46 Watts  $\approx$  208.95 kilogram-force centimeters (kgf·cm)

Based on the calculations, a DC motor rated at approximately 208.95 kilogram-force centimeters (kgf·cm) should be sufficient to excavate and lift 500 grams of wet sand under the specified conditions

**4.3 Centrifugal Drying Mechanism:**

**Scenario:**

Rotating a cylinder filled with wet sand, dimensions: height 20 cm, inner radius 5 cm, outer radius 10 cm, and 1 kg of wet sand filled up to 75% of its area.

Desired operating time: Continuous rotation for 5 minutes.

Target speed: 1000 RPM.

**Calculations:**

**Moment of Inertia (I) of the Cylinder:**

- $I = \frac{1}{2}m(r_1^2 + r_2^2)$
- $I = \frac{1}{2} \times 1 \text{ kg} \times ((0.05 \text{ m})^2 + (0.1 \text{ m})^2) \approx 0.0075 \text{ kg m}^2$

**Angular Acceleration ( $\alpha$ ):**

- $\alpha = \frac{\text{final angular velocity} - \text{initial angular velocity}}{\text{time}}$
- $\alpha = \frac{104.72 \text{ rad/s}}{300 \text{ s}} \approx 0.349 \text{ rad/s}^2$

**Torque Required ( $\tau$ ) for Continuous Operation:**

- $\tau = I \cdot \alpha$
- $\tau \approx 0.00262 \text{ N}$

For continuous rotation of the cylinder filled with wet sand for 5 minutes at 1000 RPM, a DC motor with a rated torque of at least 26.2 Newton-centimeters (N·cm) would be required.



## V. FLOW CHART

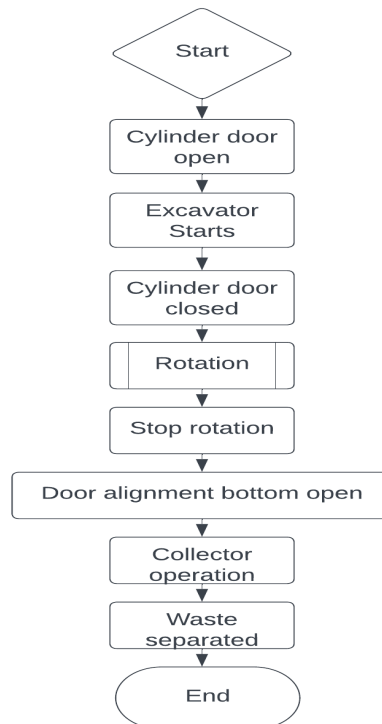

## VI. CONCLUSION

In conclusion, this project represents a conceptual breakthrough in the realm of coastal debris management. The integration of innovative technology, from the excavator's precise wet sand collection to the centrifugal drying mechanism's high-speed rotation, marks a significant stride towards more efficient and sustainable practices. The collector conveyor's systematic debris handling further exemplifies the project's holistic approach. It is important to emphasize that, at its current stage, this project stands as a conceptual framework, meticulously designed and meticulously simulated. The components utilized are part of a dynamic research and development phase, subject to potential refinement and advancement in the pursuit of operational excellence. This paper is a result of combined research and influence from authors mentioned in references. This forward-thinking perspective underscores the project's commitment to continuous improvement, positioning it on the cutting edge of environmental conservation and coastal ecosystem preservation.

As we venture into the next phases of development, the potential for real-world implementation of this innovative coastal debris management solution holds great promise. Through persistent dedication to research, innovation, and technological integration, we aim to revolutionize how we approach coastal cleanup efforts, ultimately contributing to a more sustainable and resilient marine environment for generations to come.

## REFERENCES

- [1] H. Ebrahim, W. Sheikh, A. Saeed, "Design and analysis of sustainable beach cleaner", 3C Technology. Glosses of innovation applied to SMEs, Special Edition, ISSN: 2254-4143, <https://doi.org/10.17993/3ctecno.2022.specialissue9.167-179>, 14 Feb 2022.



- [2] N. Bolong, I. Saad, M. Amran Madlan, “Manufacturing of Beach Cleaning Machine at University Malaysia Sabah (UMS) Prototype Design and Analysis”, Transactions on Science and Technology, Volume: 08, No. 3-2, 281 - 289, 02 Nov 2021.
- [3] Prof. J. Shelke, B. Bhakare, K. Lute, A. Pateshwari, H. Khodiyar, “Beach cleaning system and surface cleaning system”, International Research Journal of Modernization in Engineering Technology and Science, Volume:02, Issue:06, e-ISSN: 2582-5208, June 2020.
- [4] V. Mepani, H. Patel, Vataliya Mohil, Prof. R. Sahu, “Design and Fabrication of Beach Sand Cleaning Machine”, International Research Journal of Engineering and Technology, Volume: 07, Issue: 02, e-ISSN: 2395-0056, p-ISSN: 2395-0072, Feb 2020.
- [5] V. Dhole, O. Doke, A. Kakade, S. Teradale, Prof. R. Patil, “Design and fabrication of beach cleaning machine”, International Research Journal of Engineering and Technology (IRJET), e-ISSN: 2395-0056, Volume: 06 Issue: 04, Apr 2019.



**INNO SPACE**  
SJIF Scientific Journal Impact Factor  
**Impact Factor: 8.423**



**ISSN** INTERNATIONAL  
STANDARD  
SERIAL  
NUMBER  
INDIA



# INTERNATIONAL JOURNAL OF INNOVATIVE RESEARCH

IN SCIENCE | ENGINEERING | TECHNOLOGY

**9940 572 462** **6381 907 438** **ijirset@gmail.com**



[www.ijirset.com](http://www.ijirset.com)

Scan to save the contact details