



e-ISSN: 2319-8753 | p-ISSN: 2347-6710

IJRSET

International Journal of Innovative Research in
SCIENCE | ENGINEERING | TECHNOLOGY



INTERNATIONAL JOURNAL OF INNOVATIVE RESEARCH

IN SCIENCE | ENGINEERING | TECHNOLOGY

Volume 13, Issue 5, May 2024

ISSN INTERNATIONAL
STANDARD
SERIAL
NUMBER
INDIA

Impact Factor: 8.423

9940 572 462

6381 907 438

ijirset@gmail.com

www.ijirset.com

Design and Implementation of Automated Target Tracking System Using BOT

Nagaraj G^[1], Ganesh D^[2], Shashank S Navale^[3], Pawar Chetan Manikanta^[4]

U.G. Students, Department of Electrical and Electronics Engineering, Ballari Institute of Technology and Management, Ballari, Karnataka, India^{1][2][3][4]}

ABSTRACT: This paper proposes an automated target tracking system leveraging robotics and artificial intelligence (AI) technologies. The system integrates various sensors, including cameras, and radar, to gather data about the environment and potential targets. Through advanced AI algorithms, the system processes this data to detect, identify, and track targets in real-time. Machine learning techniques are employed for target classification and behaviour analysis, enabling the system to differentiate between threats and benign entities. The proposed system also incorporates predictive algorithms to anticipate target movements and actions, enhancing its proactive capabilities. Decision-making processes, either autonomous or involving human operators, are driven by the analysis of tracked targets and their behaviour. Continuous feedback loops facilitate system improvement over time, ensuring higher accuracy and effectiveness. Integration with control systems enables the system to take direct action based on tracked targets, optimizing operational efficiency and safety. Overall, the proposed automated target tracking system represents a significant advancement in surveillance, security, and automated manufacturing applications, offering enhanced situational awareness and threat mitigation capabilities.

KEYWORDS: DC motors, single channel relay, Raspberry Pi 3B Model, Battery, ultrasonic sensor, servo motor

I. INTRODUCTION

The demand for automated systems capable of efficiently tracking and responding to dynamic environments has never been greater. From surveillance and security to industrial automation, the ability to identify, track, and respond to targets in real-time is crucial for enhancing operational efficiency, safety, and security. This paper introduces an innovative solution: an automated target tracking system utilizing cutting-edge robotics and artificial intelligence (AI) technologies. By integrating a diverse array of sensors and sophisticated AI algorithms, this system offers a comprehensive approach to target tracking and response, promising to revolutionize various domains where accurate and timely information is paramount.

The proliferation of sensors such as cameras, and radar has enabled unprecedented data collection capabilities. Harnessing this data to extract meaningful insights and actionable intelligence remains a significant challenge. The proposed system addresses this challenge by leveraging advanced AI algorithms for data processing, enabling the system to detect, identify, and track targets with remarkable precision and efficiency. The system's machine learning capabilities enable it to adapt and learn from experience, continuously improving its accuracy and effectiveness over time. By incorporating predictive algorithms, the system can anticipate target movements and behaviors, enhancing its proactive response capabilities and mitigating potential threats before they escalate. Central to the proposed system is its integration with control systems, allowing for seamless coordination between target tracking and response mechanisms. Whether deployed in surveillance and security applications or automated manufacturing processes, this integration enables the system to take direct action based on tracked targets, optimizing operational workflows and minimizing response times.

This paper presents a novel approach to automated target tracking that combines state-of-the-art robotics and AI technologies. By offering enhanced situational awareness, proactive threat mitigation, and seamless integration with existing systems, the proposed system has the potential to revolutionize a wide range of applications, ushering in a new era of efficiency, safety, and security.

II. RELATED WORK

The Previous Concepts used to our work are: Automatic Gun Control using Motion Detection System presented by Akash Nambour and Pallavi Patil [1]; Computer vision and image processing is presented by Victor Wiley, Thomas Lucas [2]; A computer vision-based framework for visual fun detection using Harris interest point detector is presented by Rohit Kumar Tiwari, Gyanendra K. Verma [3].

III. METHODOLOGY

The methodology involves designing the system architecture, integrating sensors like cameras and lidar, and pre-processing acquired data. Object detection and tracking algorithms identify and classify potential targets, followed by behavior analysis for predicting future movements. Decision-making processes, either autonomous or involving human operators, inform appropriate responses, including alerting security personnel or adjusting parameters. Integration with control systems enables direct action based on tracked targets. Rigorous validation and testing ensure system performance, guiding iterative improvements to algorithms and hardware configurations. Continuous monitoring ensures the system remains effective and responsive to evolving requirements.

IV. BLOCK DIAGRAM AND WORKING

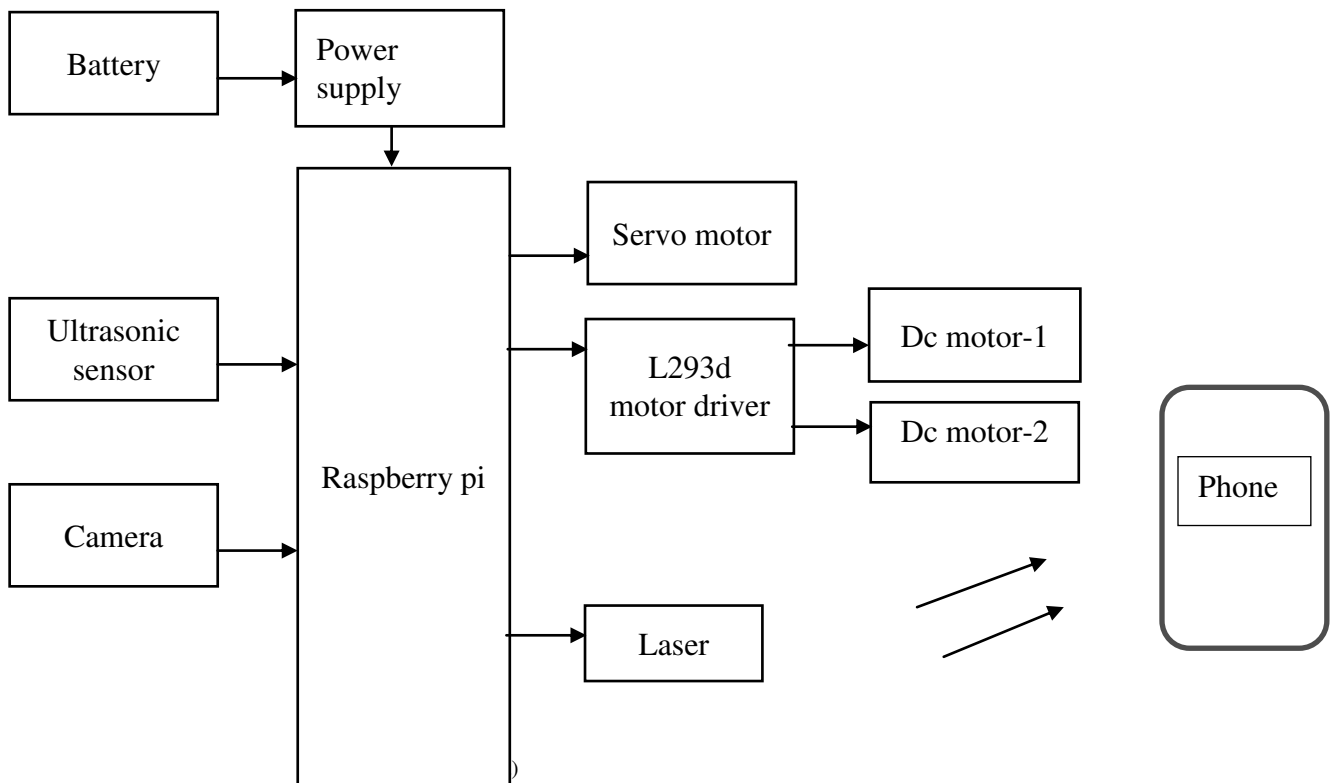

This project aims at creating a system which can be automatically track, detect and destroy the predefine target. Here we are using a Raspberry Pi 3. The people of national security agencies, maritime security organization, military forces and other forces sacrifice their lives to protect our country people. The lives of forces are also very precious like other lives. The computer-based security equipment's are very popular among the forces. This equipment's are more advance and safer. So, by using automatic target tracking gun, our army can protect our nation with minimum life losses. Real time image processing for object detection and tracking has many important applications in the field of computer vision such as video surveillance, military purposes etc. The availability of high quality and inexpensive cameras and the increasing need for automated video analysis has generated a great deal of interest in the areas of motion detection,

object tracking and object targeted. Thus, on a very high level, it is possible to identify three key steps in video analysis: detection of interesting moving objects, tracking of the detected objects from frame to frame, and analysis of the object tracks to recognize their behavior and targeted object accordingly. Our gun is a placed at one fixed position. The gun then automatically aimed and fired at the target which are detected by using image processing algorithms. We first select the object, and then the gun starts the tracking process according to the movement of camera. Once it aimed the tracked object then the gun fires automatically at targeted object.

VI. COMPONENTS USED

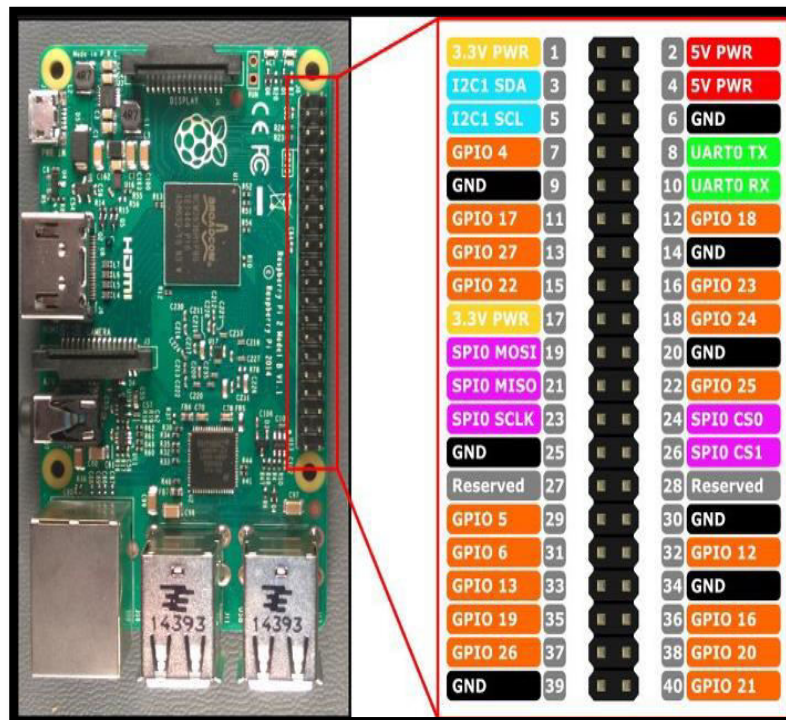
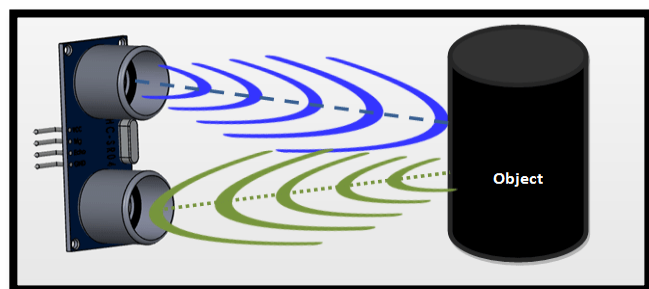

Fig (a): Pin Diagram of Raspberry Pi Model 3B

Raspberry Pi Model 3B: The Raspberry Pi 3 Model B is a popular single-board computer developed by the Raspberry Pi Foundation. It's known for its versatility and affordability, making it a favorite for hobbyists, educators, and professionals alike.



Fig(b):Ultrasonic Sensor



Fig(c):Ultrasonic sensor with sensing object

Ultrasonic sensor: An ultrasonic sensor is a device that measures the distance to an object by emitting ultrasonic sound waves and then calculating the time it takes for the sound waves to bounce back. These sensors are commonly used in robotics, industrial automation, parking assistance systems, and even in some consumer electronics.



Fig(c): Web Camera

Web camera: The Raspberry Pi can be easily turned into a surveillance system or used for video streaming purposes by connecting a webcam. You can connect a USB webcam to one of the USB ports on the Raspberry Pi 3 Model B and then use software like Motion or Open CV to capture video or images.

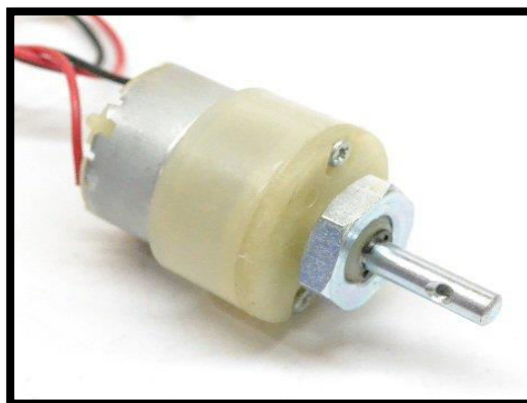

Fig(d): DC Motor

DC motor: To control a DC motor with a Raspberry Pi, you typically need additional components like a motor driver or an H-bridge circuit to interface between the Raspberry Pi's GPIO pins and the motor. The motor driver provides the necessary power and control signals to drive the motor safely.



Fig(e):Servo Motor

Servo motor: To control a servo motor with a Raspberry Pi, you typically need to use Pulse Width Modulation (PWM) to generate the control signal. Servo motors require a specific PWM signal to determine their position or angle.



Fig (f): Battery (12 v)

Battery: When using a battery with a Raspberry Pi, there are several key considerations to keep in mind. First and foremost is the voltage output of the battery. The Raspberry Pi typically requires a stable power supply of 5V, so it's crucial to select a battery that can provide a consistent voltage within this range.

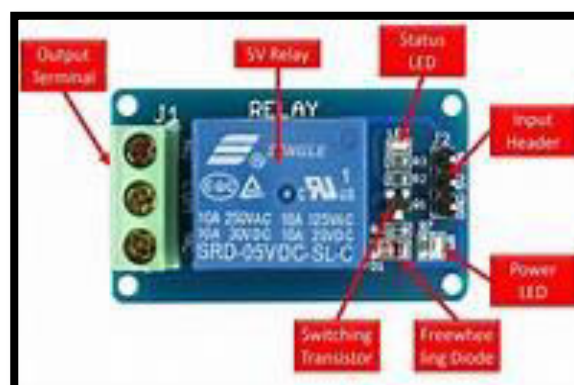

Fig (g): Single Channel Relay

Relay: To control a relay with a Raspberry Pi, you can use the GPIO pins to switch the relay on and off. A relay is an electromechanical switch that can be used to control high-power devices or circuits using low-power signals.

VII. EXPERIMENTAL RESULTS

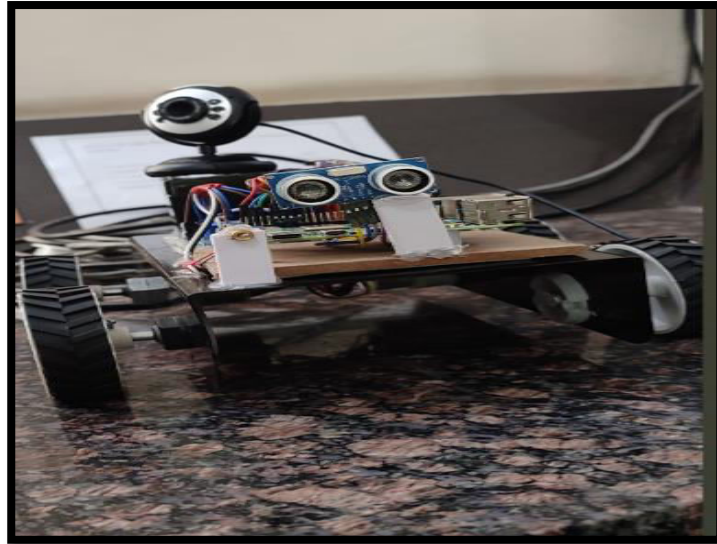

Fig (h): Automated Target Tracking System Using Bot

An automatic target tracking system with a bot could involve using sensors, such as cameras or radar, to detect and track objects, while a bot, powered by AI, could analyse the data and make decisions on how to track the targets effectively. The bot could also control any tracking mechanisms, such as moving cameras or swivelling radar arrays, to keep the targets in sight. This kind of system could be used for various purposes, from surveillance to defines applications.

The provided Python code uses OpenCV to create an automatic target tracking system. It captures video from a webcam, detects targets (faces in this example) using a pre-trained model, and draws rectangles around them. The system continuously displays the video feed, updating in real-time. By pressing 'q', the program terminates, releasing system resources.

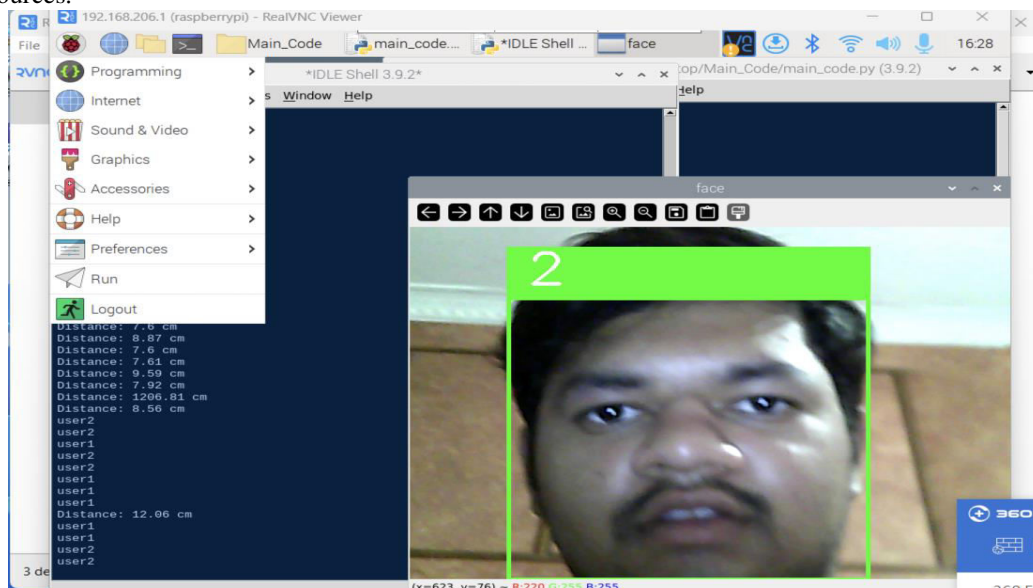
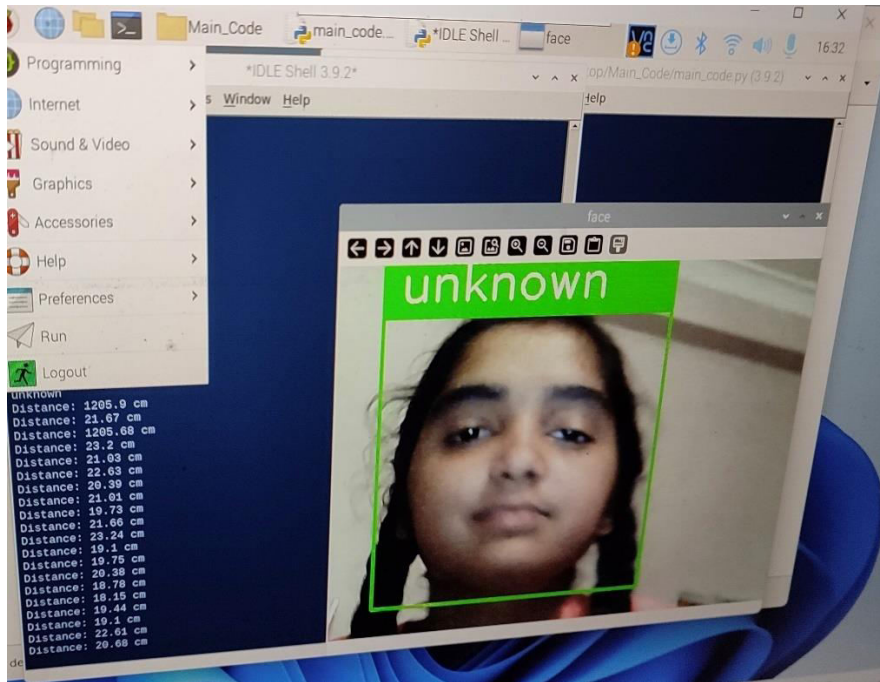

Fig (i): Capturing image of known person

From fig (i): web camera captured the image of authorised person i.e User2 and it displays the known person as User2



Fig(j): Capturing image of Unknown person

From fig(j): web camera captured the Unknown person where it invokes the raspberry pi to target the unauthorised person using laser.

VIII. CONCLUSION

The theme of the work is to design the automated security system for surveillance operations. The system is designed by using image processing algorithms in order to select, track the target automatically. The performance of the system can also be improved by using high resolution cameras with night vision provision.

REFERENCES

- [1] Akash Nimbore¹, Pallavi patil, "Automatic Gun Control using Motion Detection System" Akash Nimbore¹, Pallavi Patil and Prof. Kavita Joshi, Dept. of Electronics and Telecommunication Engineering, G H Raisina college of Engineering And Management Pune, Maharashtra, India, p-ISSN: 2395-0072, e-ISSN: 2395-0056.
- [2] Computer Vision and Image Processing: A Paper Review Victor Wiley¹, Thomas Lucas Teknik Informa tika, TSCC Jakarta Indonesia 1 victorwiley10@gmail.com*; 2 thomasreliable10@gmail.com, ISSN: 2579-7298
- [3] A Computer Vision based Framework for Visual Gun Detection using Harris Interest Point Detector Rohit Kumar Tiwari* and Gyanendra K. Verma Department of Computer Engineering, National Institute of Technology-Kurukshetra, Kurukshetra 136 119, Haryana, India.
- [4] Sampi Jana, Shubhangi Borkar, "Autonomous Object Detection and Tracking Using Raspberry Pi", Department of computer science & Engineering, Nagpur Institute of Technology, Nagpur, India.
- [5] Swetha Suresh B., Sneha B. R., "Object Tracking Robot on Raspberry Pi Using OpenCV" International Journal of Engineering Trends & Technology, ISSN 2231 5381 Volume 35 Number 4, May 2016.
- [6] R. Sureshkumar, D. Vijendra Babu, "Intrusion Detection and Automatic Gun Firing Control Mechanism" International Journal of Pure and Applied Mathematics, ISSN 1311 3395 Volume 118 Number 5, 2018.



INTERNATIONAL
STANDARD
SERIAL
NUMBER
INDIA



INTERNATIONAL JOURNAL OF INNOVATIVE RESEARCH

IN SCIENCE | ENGINEERING | TECHNOLOGY

 9940 572 462  6381 907 438  ijirset@gmail.com



www.ijirset.com

Scan to save the contact details