

# Review of Power Converters for High Voltage Direct Current (HVDC) Transmission

Omorogiuwa Eseosa<sup>1</sup>, Uchenna Emmanuel Edeh<sup>2</sup>

Senior Lecturer, Department of Electrical/Electronic Engineering, University of Port Harcourt, Nigeria<sup>1</sup>

Principal Electrical Instructor, National Power Training Institute of Nigeria (NAPTIN)<sup>2</sup>

**ABSTRACT:**The work provides review on operation of line commutated HVDC converter including its principles, configurations and derivations of converter equations. Power converters used for High Voltage Direct Current (HVDC) transmission in power network and various configurations were also reviewed. HVDC interconnections and its operations based on commutated converter including factors for choosing both Alternative Current (AC) or Direct Current (DC) transmission was investigated. Moreso, review on comparison between AC and DC transmission was carried out. Also reviewed are components of converter stations. Modelling equations for HVDC converters where also established

**KEYWORDS:** HVDC,Modelling, Thyristors, Converters

## I. INTRODUCTION

Lidong in 2002, classified Direct Current (DC) lines as Monopolar, Bipolar, Homopolar and back to back lines. Axelson *et al* in 2001 postulated that Monopolar DC lines have two configurations. These are Monopolar lines with either the earth or metal return. In a common configuration, called Monopolar, one of the terminals of the rectifier is connected to transmission line while the earthed terminal may be connected to the corresponding connection at the converting station by means of a second conductor. Monopolar lines are those in which the line has one conductor only and the return is either earth or metallic conductor as shown in Figs 1 and 2 respectively. According to Carroll *et al* (2002), it is convenient to start High Voltage Direct Current (HVDC) scheme with this configuration for so many reasons. Firstly, it is the cheapest configuration so it can be used when cost is considered. Secondly, it is the first stage of a bipolar configuration. That is a Monopolar configuration can later be converted to bipolar with time without much difficulties.



Fig1: Monopolar line with Earth Return

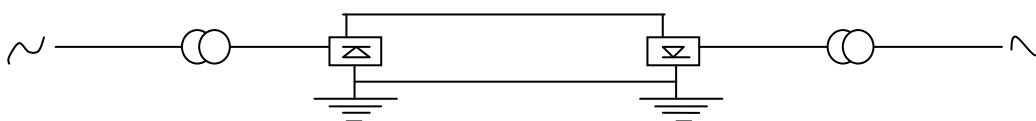

Fig 2 Monopolar line with Metallic Return.

# International Journal of Innovative Research in Science, Engineering and Technology

(A High Impact Factor, Monthly, Peer Reviewed Journal)

Visit: [www.ijirset.com](http://www.ijirset.com)

Vol. 8, Issue 8, August 2019

The bipolar have two conductors- one operating with positive polarity and the other with negative polarity. There are two conductors of equal voltage ratings and connected in series at the end of the DC line. The junction of the converters may be grounded at one end or at both ends as shown in Fig 3. If it is grounded at both ends, it means it can be operated independently.

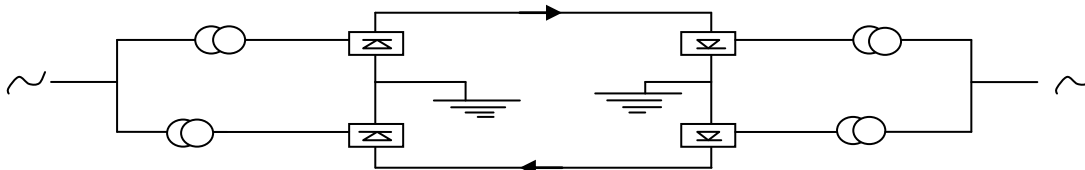

Fig 3: Bipolar line Configuration

Homopolar lines have the same polarity unlike the bipolar lines and always have earth as their return conductor as shown in fig 4

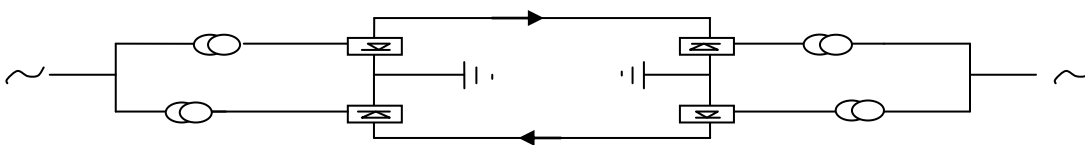

Fig 4: Homopolar HVDC System

Alok *et al* in 2012 stated that in this scheme two or more sets of converters are arranged like the bipolar configuration. In this case, the converters say one and two may be set to run as rectifier while converter three and four is set as inverters. This arrangement can be changed either ways by switching. Sood in 2004 opined that this is one of the safest ways to operate HVDC system knowing that it is more efficient because when one transmission line goes off, it will not affect the others as such the transmission system will regain its balance during fault and it is not easily affected by system failure. In back to back configuration, the two converters have no distance of separation. This is mainly used to interconnect two AC links with different frequencies. A simple representation of HVDC interconnection is shown in Fig 5.

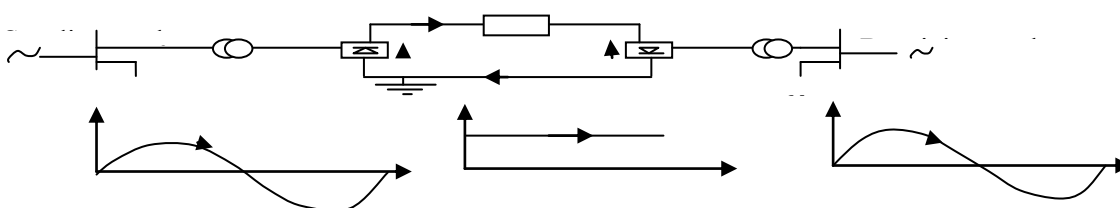

Fig. 5 HVDC Interconnections

## II. RELATED WORK

Most HVDC systems in operation today are based on commutated converter. According to Mathur *et al* in 2002, the basic Line Commutated Converters (L.C.C) configuration is made up of bridge rectifier, having six thyristors. Each one is connected to one of the three phases of the converter transformers. However, with a change only every  $60^{\circ}$ , considerable harmonic distortion is produced at both DC and AC terminals when this arrangement is used.

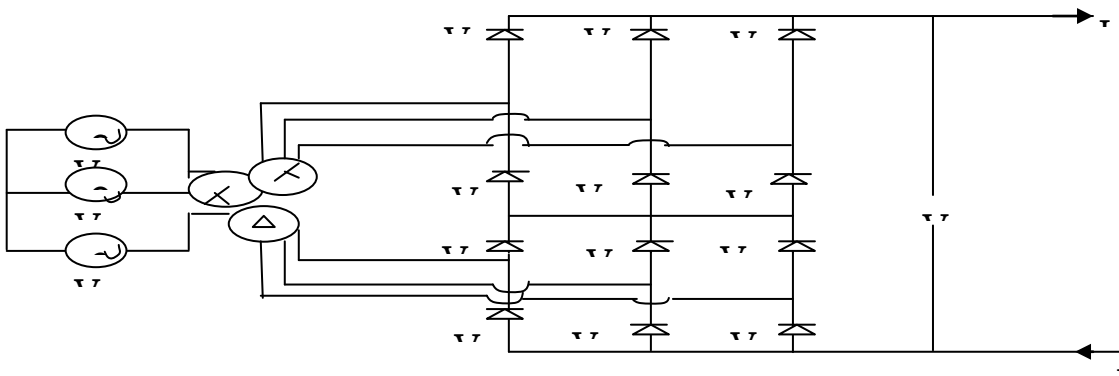

Fig 6: A Twelve Pulse Bridge Rectifier

An enhancement of this arrangement uses 12 valves in a twelve pulse bridge. The Alternating Current (AC) split into two separate three phase supplies before transformation. One of the set of supplies is then configured to have star secondary, the other delta secondary establishing  $30^\circ$  phase difference between the two DC rails. There is phase change every  $30^\circ$  and harmonics are considerably reduced. For this reason, twelve pulse systems has become standard on most line commutated converter HVDC systems built since the 1970's

### 2.1 Factors for Choosing AC or DC Transmission

Arrilaga *et al* in 1990 posited that some factors need to be put into consideration by transmission engineers before adopting any system of power transmission. Carter *et al* in 1977 listed these factors as transmission cost, efficiency and performance. Hingorani in 1968 stated that for HVDC transmission to be economical with respect to High Voltage Alternating Current (HVAC), there must be a distance above which it is possible. This is because of the cost of putting up terminal equipment. Gerherd *et al* in 1996, puts this distance to be at 500km while Mats Larson in 2009, found out that for HVDC to be cost effective, the distance must be 450km and that HVDC is more efficient than HVAC because the DC has better control mechanism and has faster recovery ability from faults. Fig7. Shows variation of costs with line length while Fig. 8 shows plot Power Transfer Capacity VS Distance

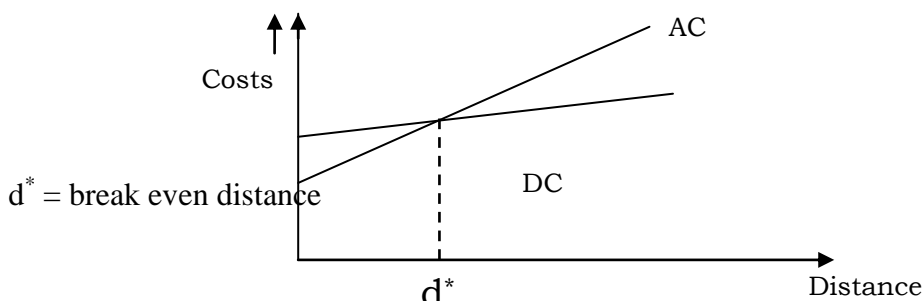

Fig. 7. Variation of costs with line length

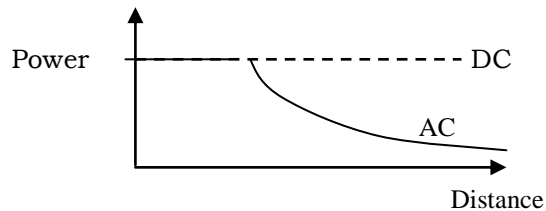

Fig. 8 Power Transfer Capacity VS Distance

### 2.2 Comparison of A.C and D.C Transmission

Wadhwa (2010), Padiyar (1991), and Hanth *et al* (1997) investigated advantages of HVDC as follows: Greater power per conductor, smaller towers for transmission, No charging current, Narrower right-of-way, requires lesser insulation for conductors, Lesser line construction cost, It can use ground return, each conductor can be operated as an independent circuit, Lesser corona loss, No Skin effect, Lower line losses, Unity power factor, Lesser radio interference, Does not necessarily need to be operated in synchronism, Distances are not limited by stability, May interconnect AC systems of different frequencies, Lesser stability problems. ( Bahrman, 2008). Fig 9 shows Tower Size for 1000mw Transmission Line.



Fig 9: Tower Size for 1000mw Transmission Line

Astom (2012) and ABB (2016) stated disadvantages of HVDC as follows: Expensive converter, Reactive Power Required, Generation of harmonics, Difficulty of circuit breaking etc.

### 2.3 Components of Converter Station

#### ➤ A.C. Switch Yard

This is the A.C system which connects to HVDC converter station. This is done via converter bus. The converter bus is simply the A.C bus bar to which the converter is connected



Fig 10 Valve hall

#### ➤ A.C. Harmonic Filters

Manmek *et al* (2004), stated that in converter station, there is generation of harmonics because of this, shunt connected switchable A.C harmonic filters are connected to the converter bus bar.

## International Journal of Innovative Research in Science, Engineering and Technology

(A High Impact Factor, Monthly, Peer Reviewed Journal)

Visit: [www.ijirset.com](http://www.ijirset.com)

Vol. 8, Issue 8, August 2019



Fig 11 Ac filters

Hanth et al (1997), further found out that A.C. Harmonic filters can be switched on automatically and off with A.C. circuit breakers.

### ➤ Converter Transformer

Asplund (2000), described converter transformer as the interference between A.C system and thyristors valves. Typically, converter transformer is arranged as an earthed star-line winding and a floating star and delta secondary windings (Acha E 2002, Cory B.J.1965, Adamson, and Hingorani 1960). The converter transfer acts as the interface between HVDC Converter and AC System and provides several functions including: giving isolation between systems and gives the right voltage to converters.

### ➤ Converter

Rectifier and inverter are called converter and give the transformation of voltages. It is mainly made up of six pulses however, recent converters are made of twelve pulse valves and the old ones also are replaced with the twelve pulse. This is the opinion of Uhlman (1971, Gupta J.B.2005, Gupta B R 2005).

### 2.3 D.C Smoothing Reactors

According to Siemens (2007), HVDC scheme for power transmission requires D.C. smoothing reactors. The D.C. smoothing reactors provides a number of functions, some of which are reduction of ripples in dc lines, reduction in fault current in the DC transmission, protection of the converter valves etc



Fig 12 Transformer used for HVDC



Fig 13 Smoothing reactors

# International Journal of Innovative Research in Science, Engineering and Technology

(A High Impact Factor, Monthly, Peer Reviewed Journal)

Visit: [www.ijirset.com](http://www.ijirset.com)

Vol. 8, Issue 8, August 2019

## ➤ D.C Filters

During the operation of converters, voltage harmonics are being generated at the D.C terminal of the converter and there are sinusoidal A.C harmonics components superimposed on the D.C terminal voltage. This A.C harmonics component of voltage will result in A.C harmonic current flow in the D.C circuit and induce harmonic current flow in the other circuits. The D.C filter is physically similar to A.C filter.

## ➤ D.C Transducers

DC connected transducers fall into two types: DC voltage scheme measurement and DC current measurement transducers

## 2.4 Rectification

A valve normally conducts in one direction only from anode to cathode and when it is conducting there is a small drop of volts across it. While analyzing the rectifier circuits, the valves and transformer are assumed to be ideal i.e. without any voltage drop and the D.C load is assumed to have infinite inductance from which it follows that the direct current is constant i.e. free from ripple. Transformer secondary can be connected to give 3 pulse, 6 pulse and 12 pulse supply to the rectifier valves. The larger the number of pulses, the lower is the ripple content and this is sufficiently good from all practical view points.

### 2.4.1 Six Pulse Bridge Converter

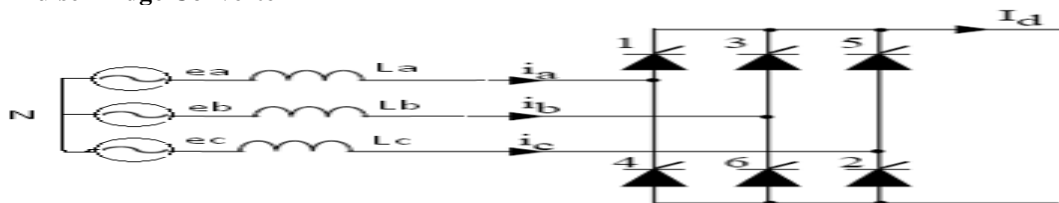

Fig 14 Graetz bridge circuit the following observations:

Exactly two thyristors are conducting at any moment as can be seen in Fig 3.2. One thyristor given at  $\omega t = 0$  and left on for  $60^\circ$ , after which a thyristor is fired every  $60^\circ$  thereafter. Thyristors turn off when they become reverse biased. This occurs whenever the voltage applied at their cathode exceeds the voltage applied at their anode. For time  $\omega t = 0$  to  $\frac{\pi}{3}$

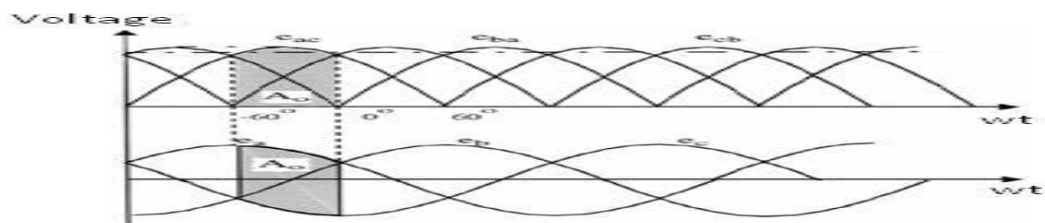

Fig 15 six pulse rectifier voltage

$e_{cb}$  is the most positive voltage relative to other line-to-line voltages. Thyristors 3 and 2 conducts if suitable pulses are applied to their respective gates. At the end of time period at  $\omega t = \frac{\pi}{3}$ , the thyristors is turned to 1 so as to apply  $e_{ab}$  across the load. Although thyristors 3 is on at  $\frac{\pi}{3}$ ,  $e_{ca}$  goes negative at that moment which reverse biases thyristors 3 and 4 commutes (turns off). This is also seen in that at this time,  $e_{ab}$  goes higher than  $e_{cb}$  and so when thyristor 1 turns on, node a has higher potential than node C so thyristors 3 reverse biases and turns off. For time period  $\omega t = \frac{\pi}{3}$  to  $\frac{2\pi}{3}$   $e_{ab}$  is the most positive voltage relative to other line-to-line voltages. Thyristors 1 and 2 conducts if suitable pulses are applied to their respective gates. At the end of the time period, at  $\omega t = \frac{2\pi}{3}$ ,  $e_{cb}$  goes negative at that moment which reverse biases



## International Journal of Innovative Research in Science, Engineering and Technology

(A High Impact Factor, Monthly, Peer Reviewed Journal)

Visit: [www.ijirset.com](http://www.ijirset.com)

Vol. 8, Issue 8, August 2019

thyristors 2 and it commutates and so on. To begin with, a 3-pulse arrangement will be described but analysis will be done for a general  $n$  – phase system. The 3-pulse system is the simplest converter circuit but is not practical because the direct current in the secondary windings, saturate the transformer core. The conduction starts from  $[\frac{\pi}{2} - \frac{\pi}{2}]$  to  $[\frac{\pi}{2} + \frac{\pi}{2}]$ . Now since conduction taken place only during the positive half cycle, the average value of D.C voltage will be

$$V_o = \frac{V_m \sin \frac{\pi}{n}}{\frac{\pi}{n}} \tag{1}$$

$$V_o = \frac{V_m \sin \frac{\pi}{6}}{\frac{\pi}{n}} \tag{2}$$

$$V_o = \frac{3V_m}{\pi} \tag{3}$$

For six pulse

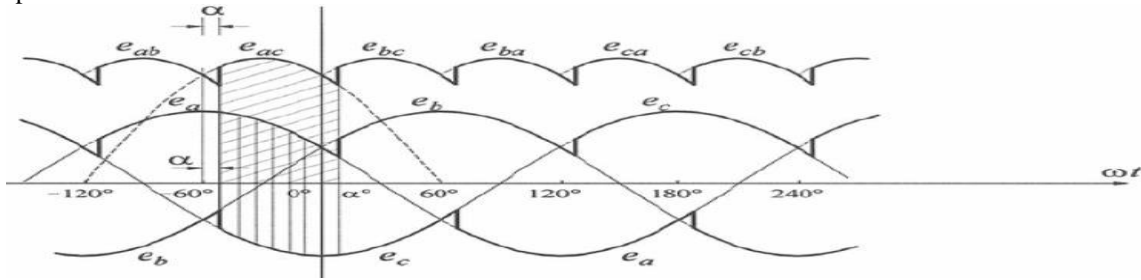

Fig 16 Output voltage with delay angle

When delay is  $\alpha$  considering  $n$ - phase system the average output voltage will be

$$= \frac{nV_m}{2\pi} [-\cos\alpha] \pi r^2 \frac{\pi}{\pi} + \alpha + [\sin \frac{\pi}{\pi} - \alpha] \tag{4}$$

$$= \frac{nV_m}{2\pi} [-\cos\alpha] \frac{\pi}{\pi} + \alpha + [\sin \frac{\pi}{\pi} - \alpha] \tag{5}$$

$$= \frac{nV_m}{2\pi} [\sin \frac{\pi}{\pi} + \alpha] + [\sin \frac{\pi}{\pi} - \alpha] \tag{6}$$

$$= \frac{nV_m}{\pi} \sin \frac{\pi}{\pi} \cos\alpha \tag{7}$$

$$= V_o \cos\alpha \tag{8}$$

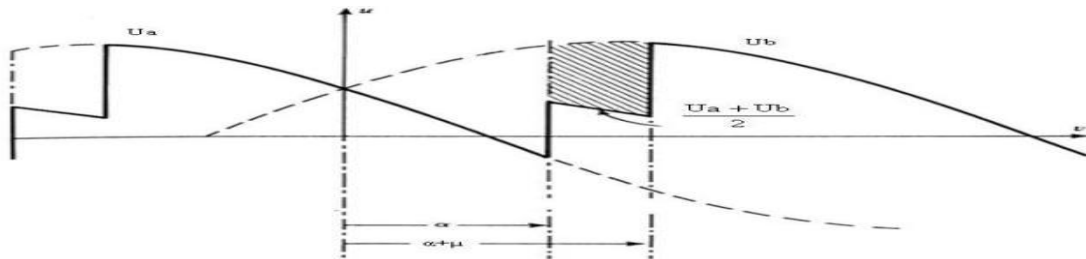

Fig 17 Output voltage with overlap angle.

With overlap angle  $\mu$ , the d.c voltage will be gotten from the hatched area

$$V_o = \int_{\alpha}^{\alpha+\mu} \frac{u_a + u_b}{2} d\omega t \tag{9}$$

## International Journal of Innovative Research in Science, Engineering and Technology

(A High Impact Factor, Monthly, Peer Reviewed Journal)

Visit: [www.ijirset.com](http://www.ijirset.com)

Vol. 8, Issue 8, August 2019

$$\text{Where } \frac{u_a + u_b}{2} = \frac{\sqrt{3}V_m}{2} \sin \omega t \quad 10$$

$$V_a = \int_{\alpha}^{\alpha+\mu} \frac{\sqrt{3}V_m}{2} \sin \omega t dt \quad 11$$

$$V_a = \frac{\sqrt{3}V_m}{2} \cdot [\cos \alpha]_{\alpha}^{\alpha+\mu} \quad 12$$

$$V_a = \frac{\sqrt{3}V_m}{2} \cdot [\cos \alpha - \cos(\alpha + \mu)] \quad 13$$

The average value of this drop =  $\frac{n}{2\pi}$  [Area] for 3 phase, n = 3

$$\frac{3}{2\pi} \cdot \frac{\sqrt{3}V_m}{2} \cdot [\cos \alpha + \cos(\alpha + \mu)] \quad 14$$

The D.C output will be

$$V_o \cos \alpha = -\frac{V_o}{2} [\cos \alpha + \cos(\alpha + \mu)] \quad 15$$

$$V_o = -\frac{V_o}{2} [\cos \alpha + \cos(\alpha + \mu)] \quad 16$$

### 3.1 CURRENT RELATIONSHIP IN BRIDGE CIRCUIT

In case of circuit, the valves conduct simultaneously. These two valves correspond to two different phases i.e. two phases are short circuited. Let L be the inductance in henry for each phase  $i_s$  be the current at any instant; then the equation describing the circuit will be;

$$2L \frac{di_s}{dt} = \frac{\sqrt{3}V_m}{2L} [\sin \omega t] \quad 17$$

$$\frac{di_s}{dt} = \frac{\sqrt{3}V_m}{2L} [\cos \omega t dt] \quad 18$$

$$I_s = -\frac{\sqrt{3}V_m}{2L} [\cos \omega t + A] \quad 19$$

At the beginning when  $\omega t = \alpha$ ,  $i_s = 0$  at the end when  $\omega t = \alpha + \mu$ ,  $i_s = I_d$ .

$$A = \frac{\sqrt{3}V_m}{2\omega L} \cos \alpha \quad 20$$

$$I_d = \frac{\sqrt{3}V_m}{2\omega L} [\cos \alpha - \cos(\alpha + \mu)] \quad 21$$

$$I_d = \frac{\sqrt{3}V_m}{\sqrt{2}X_C} [\cos \alpha - \cos(\alpha + \mu)] \quad 22$$

When  $V_L$  = r.m.s line to line voltage

Now for the bridge circuit

$$V_o = \frac{\sqrt{3}V_m}{2} \quad 23$$

$$\sqrt{3}V_m = \frac{\pi V_o}{3} 24$$

$$I_d = \frac{\pi V_o}{6X_C} [\cos \alpha - \cos(\alpha + \mu)] \quad 25$$

We know that, the bridge output voltage after taking into account grid control and over lap  $\mu$  is

$$V_o = -\frac{V_o}{2} [\cos \alpha + \cos(\alpha + \mu)] \quad 26$$

Here  $V_o$  is the bridge rectifier voltage without grid control and overlap.

Now adding the two equations 18 and 27



## International Journal of Innovative Research in Science, Engineering and Technology

(A High Impact Factor, Monthly, Peer Reviewed Journal)

Visit: [www.ijirset.com](http://www.ijirset.com)

Vol. 8, Issue 8, August 2019

For 12 pulse, $\frac{2V_d}{V_o} + \frac{6X_C I_d}{\pi V_o} = 2\cos\alpha$	27
$\frac{V_d}{V_o} + \frac{3X_C I_d}{\pi V_o} = \cos\alpha$	28
$V_d = V_o \cos\alpha - \frac{3X_C I_d}{\pi}$	29
For 12 pulse, $V_d = \frac{\sqrt[3]{2}}{\pi} V_L \cos\alpha - \frac{3X_C I_d}{\pi}$	30
The consumption of reactive power is given as $Q = P \tan\phi$	31
$\cos\phi = \cos\alpha - 3X_C I_d / \pi V_o$	32
Since the rectifier can operate as a inverter when firing angle increases from 90 degrees to 180 degrees, it is convenient to express the inverter equation in terms of its extinction angle as $\gamma = 180 - \alpha - \mu$	33
$\mu$ represents overlap angle $V_d = V_o \cos\gamma - 3X_C I_d / \pi$	34

### IV. CONCLUSION

This work reviewed power converters used for High Voltage Direct Current (HVDC) transmission in power network. Various configurations were also reviewed. These include homo polar and bi polar line configurations. HVDC interconnections were considered. Operations of HVDC based on commutated converter including factors for choosing both Alternative Current (AC) or Direct Current (DC) transmission was investigated. Moreover, review on comparison between AC and DC transmission was carried out. Also reviewed are components of converter stations such as AC switch yard, AC harmonic filters, converter transformers, DC smoothing reactors, DC filters as well as rectification section. Modelling equations for HVDC converters were also established.

### Acknowledgement

The authors wish to acknowledge and say a big thank you to members of staff of eseogietec engineering company ([www.eseogietec.com](http://www.eseogietec.com)) for all the support academically and financially given towards the completion of this work.

### REFERENCES

1. ABB, The early HVDC development, available from: [http://www.abb.com/global/scot/scot221.nsf/veritydisplay/8cf1c44dbc522685c12574e9006051a5/\\$File/The%20early%20HVDC%20development.pdf](http://www.abb.com/global/scot/scot221.nsf/veritydisplay/8cf1c44dbc522685c12574e9006051a5/$File/The%20early%20HVDC%20development.pdf).
2. Acha, E., Agelidis, V.G., Anaya-Lara, O., and Miller, T.J.E. *Power electronic control in electrical systems*, Butterworth-Heinemann, ISBN: 0750651261, January 2002.
3. Adamson, C and Hingorani N, G., *High Voltage Direct Current Power Transmission*, Garaway Ltd., 1960.
4. Alok Kumar Mohanty and Amar Kumar Barik (2012), "HVDC LIGHT and FACTS Technology: A Modern Approach to Power System Interconnections", *Proc. International Journal of Engineering Research and Applications*, Vol. 2, Issue 2, pp.1331-1336.
5. Arrillaga, J., C. P. Arnold, *Computer Analysis of Power Systems*, University of Canterbury, John Wiley & Sons, 1990.
6. Asplund, G, Eriksson, K, Drugge, B(1997) *Electric power transmission to distant loads by HVDC Light*, Distribution 2000, Sydney, Australia.
7. Astom *HVDC for beginners and beyond*, journals Sept 2010 PG 22-25, 31-36.
8. Axelsson A. Knosh G. (2001), *The Gotland HVDC Light Project – Experiences from trial and Commercial Operation*, Cired, Amsterdam, Holland.
9. Carroll, E. and Siefken, J. IGBTs: moving on the right track, *Power Electronics Technology*, v 28, n 8, August 2002, p. 16-18, 20-22.
10. Carter, T., Grund, K. C. E. Happ, H. H. And Pohl, R. V. *The dynamics of AC-DC systems with controlled multiterminal HVDC transmission*, IEEE Transactions on Power Apparatus and Systems. PAS-96, pp. 402-413, March/April 1977. Vol .(13).
11. Cory B.J. High voltage direct current converter and system, macdonard, London, 1965.
12. Gerhard Schmidt, Bernd Fiegl and Stefan Kolbeck *HVDC transmission and the environment power engineering journal*, p 204-10, Oct 1996.
13. Gupta B.R., *Power system analysis and design* S. Chand and company limited Ran Nagor, New Delhi, 2005.

## International Journal of Innovative Research in Science, Engineering and Technology

(A High Impact Factor, Monthly, Peer Reviewed Journal)

Visit: [www.ijirset.com](http://www.ijirset.com)

Vol. 8, Issue 8, August 2019

14. Gupta J. B, A course in electrical power, S.K Katira and sons Nai Sarak ,New Delhi 2005.
15. Hanth R.L, Tatro P. J, Railing B. D., Johnson B.K, Starwart J. R, and Phin J. L *HVDC Power Transmission Technology Assessment Report*, Oak Ridge National Laboratory April 1997.
16. Hingorani N. G. and Chadwick, P "A new constant extinction angle control for AC/DC/AC static convertors", IEEE Transactions on Power Apparatus and Systems, Vol. 87, pp. 866-872, March 1968.
17. Kundur P, *Power system transmission and control* The EPRI power system engineering series Mc Graw Hill 1994.
18. Lidong Z., Lars D, A Novel Method of Mitigate Commutation Failures in HVDC Systems, *Proceedings Power Con 2002. International Conference on*, Volume: 1, 13-17 Oct. 2002, pp 51-56.
19. Manmek T., Grantham C., and Phung T., A real time harmonics measuring techniques under noisy conditions, Australasian University Power Engineering Conference Brisbane Australia 2004.
20. Mathur, R.M. and R.K. Varma, *Thyristor-based FACTS controllers for electrical transmission systems*, J. Wiley & Sons Inc., ISBN: 0471206431, February 2002.
21. Mats Larsson, Corporate Research, ABB Switzerland Ltd, HVDC and HVDC Light: *An alternative power transmission system, Symposium on Control & Modeling of Alternative Energy Systems*.(2009).
22. Padiyar, K. R. *HVDC power transmission systems: technology and system interactions*, J Wiley & Sons Inc., September 1991.
23. Robert Rudervall, J.P. Charpentier, Raghuvveer Sharma, *High Voltage Direct Current (HVDC) Transmission Systems Technology Review Paper*, in *Energy Week 2000*, Washington, D.C, USA, March 2000.
24. Saadat H. *Power system analysis*. Mc Graw Hill international edition 1999.
25. Siemens AG, *High voltage direct current transmission- proven technology for power exchange*, Mars 2007, brochure from SIEMENS, Order No. E50001-U131-A92-V2-7600, <http://www.siemens.com/ptd>.
26. Sood, V.K. *HVDC and FACTS controllers: applications of static convertors in power systems*, Kluwer Academic Publishers, ISBN: 1402078900, 2004.
27. Taylor, C. W, *Power system Voltage stability*, McGraw-Hill, 1994.
28. Uhlman E., *Power Transmission by Direct current* New York Jonhson Wiley and sons 1971.
29. Wadhwa, C, L, *Electrical Power Systems* sixth edition New Age International publishers New Delhi, 2010.
30. Weimers, L., AC or DC: which way should China go?, *Modern Power Systems*, v 25, n 8, September 2005, p 11-17.