

International Journal of Innovative Research in Science, Engineering and Technology

(A High Impact Factor, Monthly, Peer Reviewed Journal)

Visit: www.ijirset.com

Vol. 8, Issue 11, November 2019

Analysis of FSAE Rollcage

Soham Uchagaonkar¹, Shubham Agarwal², Shubham Singh³

Department of Mechanical Engineering, JSPM'S Rajarshi Shahu College of Engineering, Savitribai Phule Pune
University, Maharashtra, India^{1,2,3}

ABSTRACT: According to the Formula Student Standards, we have to design a rollcage. The overall rigidity and strength of the rollcage is crucial towards the driver's safety. Thus we have to consider different dynamic crash conditions and also simulate the results in order to ensure a significant FOS of the rollcage. In this paper, we have used the method of Finite Element Analysis for simulation purpose, and ANSYS 16.0 as a simulation tool. The appropriate material, proper mesh size and style to ensure the maximum accuracy of the results and least computation time has been determined. Also, the respective boundary and loading conditions have been explained for the respective dynamic impact conditions with the calculation of the impact forces. And finally the rollcage has been analysed for a considerable factor of safety during dynamic conditions like front, rear and side impact and also the value of torsional rigidity of the rollcage.

KEYWORDS: Rollcage, Torsional Rigidity, FEA, ANSYS 16.0, Meshing, Factor of Safety.

I. INTRODUCTION

A rollcage is a specially engineered and constructed frame built around the passenger compartment of a vehicle to protect its occupants against injury in the event of a crash or especially a rollover. There are many different rollcage designs, depending on the application and the rules and regulations vary according to it.

A rollcage helps to stiffen the chassis, which is highly desirable in racing applications. A rollcage may be secured by bolting or welding, with the latter being substantially stronger. A roll-hoop, placed behind the driver essentially prevents direct head injury to the driver in case of a rollover.

II. PROBLEM STATEMENT

To analyze the proposed design of the rollcage under various dynamic crash conditions and ensure appropriate factor of safety.

III. OBJECTIVES

- a) To find out the maximum stress, deformation and FOS generated in the rollcage due to following cases of impact using numerical method and ensure that they are within limits.
The various cases include:
 - Front impact
 - Rear impact
 - Side impact
- b) To determine the torsional stiffness of the rollcage.
- c) To determine the resonant frequency of the rollcage.

International Journal of Innovative Research in Science, Engineering and Technology

(A High Impact Factor, Monthly, Peer Reviewed Journal)

Visit: www.ijirset.com

Vol. 8, Issue 11, November 2019

IV. METHODOLOGY

1. Material Selection^[2]:

Comparison between AISI 1018 and AISI 4130:

AISI 1018 Carbon Steel

AISI 1018 has excellent weldability and produces a uniform and harder case and it is considered as the best steel for carburized parts. AISI 1018 offers a good balance of toughness, strength and ductility.

AISI 4130 Alloy Steel

AISI 4130 contains chromium and molybdenum as strengthening agents. It has low carbon content, and hence it can be welded easily. It also has more tensile strength and greater stiffness to weight ratio than AISI 1018 Carbon Steel, due to which it has been selected for rollage.

Material	AISI 1018	AISI 4130
Density	7.87g/cc	7.85 g/cc
Hardness, Brinell	126	217
Tensile Strength, Ultimate	440 MPa	560 MPa
Tensile Strength, Yield	370 MPa	460 MPa
Poisson's Ratio	0.29	0.29
Young's Modulus	205 GPa	200 GPa
Shear Modulus	80 GPa	80 GPa
Elongation at Break	15.0%	21.5%

Table 1

2. Proposed Geometry:

The proposed design of the rollage is as shown below:

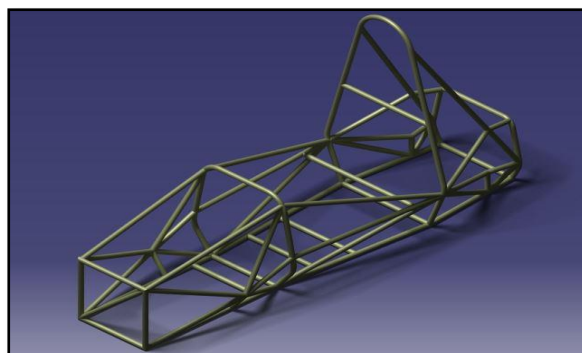

Fig. 1

International Journal of Innovative Research in Science, Engineering and Technology

(A High Impact Factor, Monthly, Peer Reviewed Journal)

Visit: www.ijirset.com

Vol. 8, Issue 11, November 2019

Analysis of the rollage with FEA ^{[3][4]}:

3. Introduction to finite element analysis (FEA):

a) Why FEA?

Basically there are three methods to solve any Engineering Problem,

1. Analytical Method
2. Experimental Method

For analysis of the rollage, the two methods stated above are not possible. Hence, we have to use a numerical method for such complex geometry.

Numerical Method:

Numerical methods are the methods that are used to approximate the solution of complicated problems. They are very useful as they are suitable for the use with computers efficiently.

Main advantage of this method is, it can solve the complex problems efficiently and gives you the results which are close to actual solution.

a) What is FEA?

Finite Element Analysis is a numerical technique for finding approximate solutions to boundary value problems for partial differential equations. The Finite Element Analysis is a computational technique for obtaining approximate solutions to the partial differential equations that arise in scientific and engineering applications. Finite Element Method utilizes a changing problem that involves an integral of the differential equation over the problem domain. This domain is divided into a number of sub domains called Finite Element and the solution of the partial differential equation is approximated by a simpler polynomial function on each element. These polynomials have to be pieced together so that the approximate solution has an appropriate degree of smoothness over the entire domain. Once this has been done, the changing integral is evaluated as a sum of contributions from each finite element. The result is an algebraic system for the approximate solution having a finite size rather than the original infinite-dimensional partial differential equation. Thus, Finite Element process has discretised the partial differential equation.

Type of Meshing:

2D Elements:

2D Elements has "Surface" as an element shape. When two of the dimensions are very large in comparison with remaining one, we use 2D type element. Additional data required from the user is thickness of the surface.

Element Type: Membrane, Thin Shell, Plane Stress, Plain Strain etc.

Element Shape: Quad, Tria.

Practical Applications: Sheet Metal Parts, Surface geometries, etc.

Why 2D meshing is carried out on Mid Surface?

Quite often the geometry of thin walled 3D structures is simplified to a geometric model with lower dimensionality. This is typically called a Mid Surface. The Mid Surface model is then meshed with 2D elements. Thus, there is no need for a detailed volume mesh as the thickness of the geometry is virtually assigned to the 2D elements. Mathematically, the element thickness (specified by the user) is assigned with half in the +z direction (element top) and the other half in the -z direction (element bottom).

International Journal of Innovative Research in Science, Engineering and Technology

(A High Impact Factor, Monthly, Peer Reviewed Journal)

Visit: www.ijirset.com

Vol. 8, Issue 11, November 2019

WHY PARTICULARLY 2D MESH?

1d element	2d element	3d element
Less Accurate	Most Accurate - Preferable	As the 3 dimensions are not considerable it is not required
Level of Assumptions is more <ul style="list-style-type: none"> • Didn't capture the geometry • Calculations on the joints are not captured 	Level of Assumptions is very less <ul style="list-style-type: none"> • Capture the geometry properly • Give results on joints 	Level of Assumptions is average <ul style="list-style-type: none"> • Capture the geometry properly • Give results on joints
Beam element meshing	Quad or Tria or Mixed meshing	Tetra element meshing
Input required in terms of cross section	Input required in terms of thickness	No input is required
1D elements are stiffer so application forces are more which may lead to over design	2D quad elements have appropriate stiffness so results will be more accurate	3D tetra elements are more stiffer so results are not up to the mark
Average element size 3mm	Average element size is 4 to 5mm to capture the geometry properly	Average element size is 3 to 5mm to capture the geometry properly

Table 2

Hence, we have to extract mid surface of rollcage first and then perform 2D meshing on it.

Determining Element size:

1. Linear static analysis could be easily carried out quickly with a large number of nodes and elements, but crash nonlinear, CFD, or dynamic analysis takes a lot of time. Keeping control on the number of nodes and elements is necessary.
2. Hardware configuration and graphics card capacity of the available computer. CAE Engineer knows the limit of the nodes that can be satisfactorily handled with the given hardware configuration.
3. The above cases need previous experience and work.
4. But if, one is very new to CAE then how he/she will decide appropriate element size? Steps to determine the element size are listed below:
 - a. Accept the default element size.
 - b. Mesh with the basic rules.
 - c. Run the analysis and observe the high stress regions.
 - d. Re-mesh the localized area of high stress with smaller element size and solve again.
 - e. Compare the difference in the original and the new results.
 - f. Continue the process until convergence is achieved (5 to 10% difference in maximum stress value).

For analysis of our rollcage, we got results depending upon the size of element as follows:

Element Size	30	20	10	5
Max. Equivalent stress	114.75	191.68	275.61	287.10
% Error	40.13	30.45	4	-

Table 3

International Journal of Innovative Research in Science, Engineering and Technology

(A High Impact Factor, Monthly, Peer Reviewed Journal)

Visit: www.ijirset.com

Vol. 8, Issue 11, November 2019

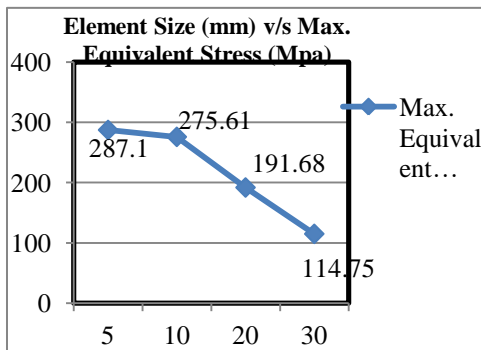

Fig. 2



Fig. 3

Thus to be more specific, we have used 2D Quad and Tria Elements with element size of 5mm as per the above discussion.

4. Calculations of Impact forces and results of Analysis of various impact cases: Static Structural Analysis^[6]:

I. Front Impact:

During Front Impact we assume that, car will collide on a rigid body with speed of 60kmph. For frontal impact we apply impact force on front bulkhead with fixed rear suspension points. Here, we calculated Impact Force as follows:

Work Done = Change in Kinetic Energy (K.E.)

Change in K.E. = Final K.E. - Initial K.E.

$$= \left[\left(\frac{1}{2} \times m \times V_f^2 \right) - \left(\frac{1}{2} \times m \times V_i^2 \right) \right]$$

Where, m = Mass of total vehicle with driver (270 kg)

V_f = Final Velocity (0m/s)

V_i = Initial Velocity (16.67m/s)

Change in K.E. = 37515N \approx 37550N

Work Done = Force (F) \times Displacement (d)

Displacement (d) = Impact time(t) \times Velocity (V)

Impact time for rigid and deformable objects is taken as 0.1s and 0.3s respectively.

Thus, Displacement (d) = 0.1 \times 16.67 = 1.667m

Impact Force (F) = Work Done / Displacement

Impact Force (F) = 22.555kN

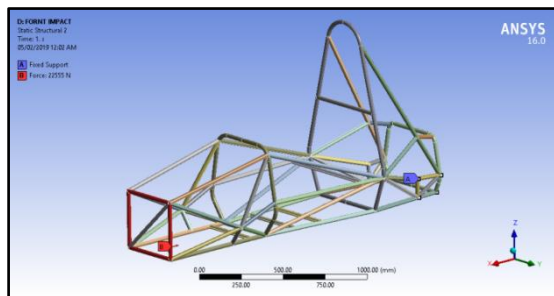

Fig. 4

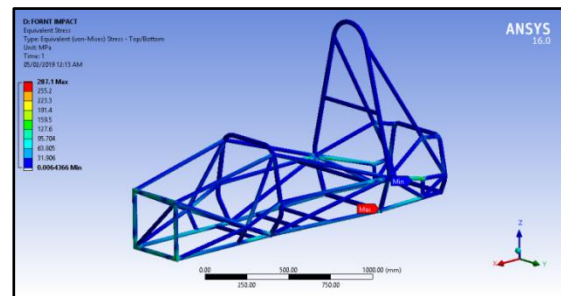

Fig. 5

International Journal of Innovative Research in Science, Engineering and Technology

(A High Impact Factor, Monthly, Peer Reviewed Journal)

Visit: www.ijirset.com

Vol. 8, Issue 11, November 2019

II. Rear Impact:

During Rear Impact we assume that, other car will collide on our car with speed of 80kmph. For rear impact, we apply impact force on rear bulkhead with fixed front suspension points. Here, we calculated Impact Force with the help of Conservation of Kinetic Energy Equation as follows,

Work Done = Change in Kinetic Energy (K.E.)

Change in K.E. = Final K.E. –Initial K.E.

$$= \left| \left(\frac{1}{2} \times m \times V_f^2 \right) - \left(\frac{1}{2} \times m \times V_i^2 \right) \right|$$

Where, m = Mass of total vehicle with driver (270 kg)

V_f = Final Velocity (0m/s)

V_i = Initial Velocity (22.22m/s)

Change in K.E. = 66653.3N \approx 66660N

Work Done = Force (F) \times Displacement (d)

Displacement (d) = Impact time (t) \times Velocity (V)

Impact time for rigid and deformable objects is taken as 0.1s and 0.3s respectively.

Displacement (d) = 0.3 \times 22.22 = 6.666m

Impact Force (F) = Work Done / Displacement

Impact Force (F) = 10kN

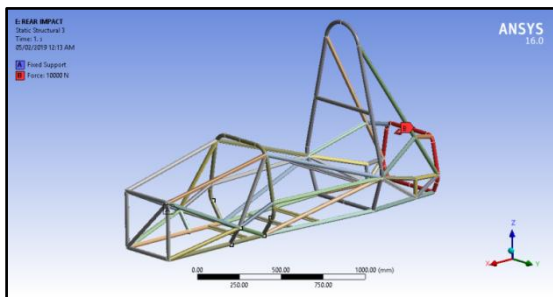

Fig. 6

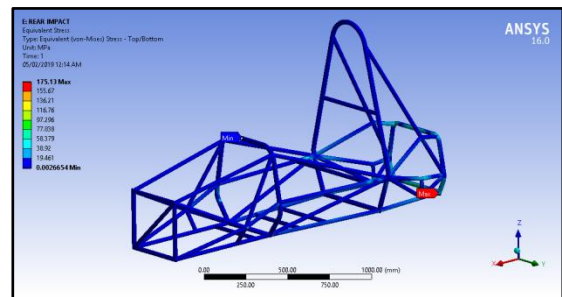

Fig. 7

III. Side Impact:

During Side Impact we assume that, other car will collide on our car with speed of 80kmph. For side impact, we apply impact force on side impact members with fixed other side's suspension points. Here, we calculated Impact Force with the help of Conservation of Kinetic Energy Equation same as in case of rear impact.

Impact Force (F) = 10kN

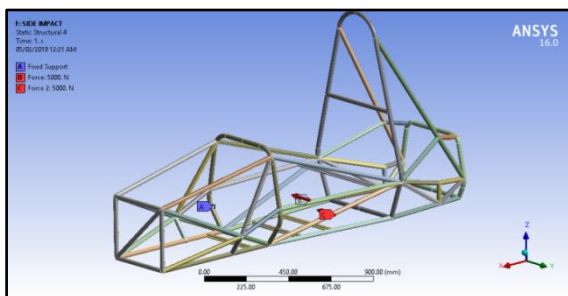

Fig. 8

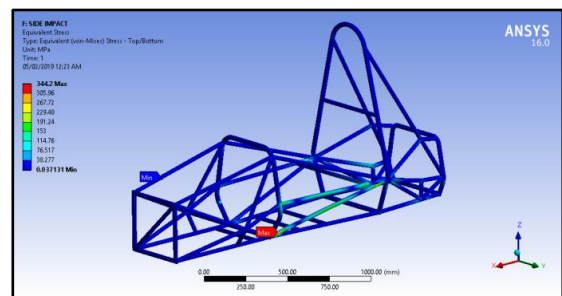

Fig. 9

International Journal of Innovative Research in Science, Engineering and Technology

(A High Impact Factor, Monthly, Peer Reviewed Journal)

Visit: www.ijirset.com

Vol. 8, Issue 11, November 2019

IV. Torsional Rigidity^[7]:

It is one of the important properties of the Rollcage. Rollcage should be stiff enough to resist the deformation in case of maximum bump condition. Thus for this analysis, we totally constrain rear suspension point. Torsional rigidity can be given as,

$$\text{Torsional Rigidity} = \frac{\text{Torque experienced by Rollcage in Max. Bump}}{\text{Angle of deflection of the Rollcage}}$$

Torque due to Max. Bump Force = (Max. Bump Force) × (Half of the distance between two respective front suspension points which undergo maximum deformation along Z direction)

Max. Bump force is given by 3g force of total mass of vehicle with driver as follows,

$$\text{Max. Bump force} = 3 \times g \times m = 3 \times 10 \times 270$$

Max. Bump force = 8100N

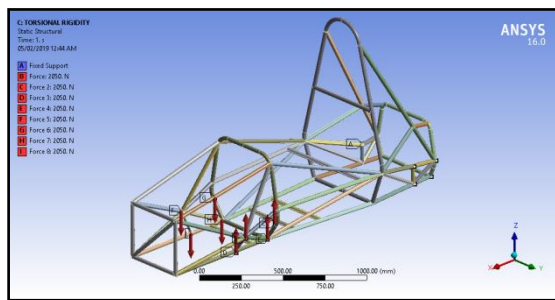

Fig. 10

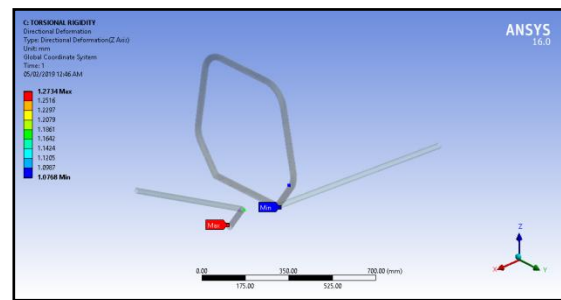

Fig. 11

From the result of directional deformation as shown in the figure above, it is clear that max. Deformation (approximately 1.3mm) is experienced by one of the front suspension points. Distance between this and its respective point on the other side is easily determined by the CAD. This comes out to be 370mm.

$$\text{Torque due to Max. Bump Force} = 8100 \times \frac{0.37}{2}$$

Torque due to Max. Bump Force= 1498.5N-m

Now to find out the approximate rotational displacement of this point, we will take the maximum displacement triangle as shown in figure below,

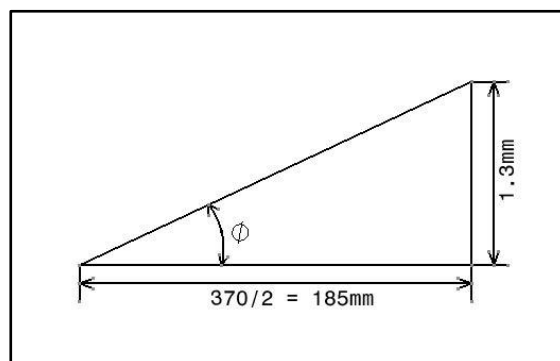

Fig. 12

Angle Φ can be calculated by trigonometric function as,

$$\begin{aligned} \Phi &= \tan^{-1} \frac{1.3}{185} \\ &= 0.4026^\circ \end{aligned}$$

International Journal of Innovative Research in Science, Engineering and Technology

(A High Impact Factor, Monthly, Peer Reviewed Journal)

Visit: www.ijirset.com

Vol. 8, Issue 11, November 2019

Torsional Rigidity can be given as,

Torsional Rigidity= (Torque due to Max. Bump Force/ Φ)

$$= \frac{1498.5}{0.4026}$$

Torsional Rigidity = 3722N-m/deg.

III. SUMMARY OF RESULTS

Impact Cases	Force Applied (N)	Max. Equi. Stress (MPa)	Max. Deform. (mm)	Min. Factor of Safety
Front Impact	22555	287.10	2.40	1.60
Rear Impact	10000	175.13	0.65	2.62
Side Impact	10000	341.05	3.06	1.33
Torsional Rigidity	8100	344.20	1.39	1.34

Table 4

IV. CONCLUSION

This study explores various cases of static analysis on the rollcage, selection of the appropriate meshing style and element size in finite element analysis. In the results it can be seen that for each case, a significant factor of safety for the proposed design of the rollcage has been achieved. Thus, the proposed design can withstand the worst conditions of the dynamic crashes and ensure the safety of the driver. Hence, we can conclude that proposed design of the rollcage is safe and reliable.

REFERENCES

1. Formula Student Rule Book, www.formulabharat.com
2. www.makeitfrom.com, asm.matweb.com
3. Elevation Academy, www.elevation.com
4. Matthias Goelke, (2014). "Practical Aspects of Finite Element Simulation", Altair University INDIA
5. www.fsae.com/forums
6. Frank Bullen Vishy Karri, Design and Construction of a Formula SAE Race car in a Teaching and Research Framework, Herds (2002)
7. KamenUzunov, StaykoTzenov, Design of Formula Student Vehicle Proceedings of University of Ruse – 2016, Vol.55, Book 1.1