



e-ISSN: 2319-8753 | p-ISSN: 2320-6710

IJRSET

International Journal of Innovative Research in
SCIENCE | ENGINEERING | TECHNOLOGY

INTERNATIONAL JOURNAL OF INNOVATIVE RESEARCH

IN SCIENCE | ENGINEERING | TECHNOLOGY

Volume 9, Issue 12, December 2020

ISSN INTERNATIONAL
STANDARD
SERIAL
NUMBER
INDIA

Impact Factor: 7.512

9940 572 462

6381 907 438

ijirset@gmail.com

www.ijirset.com

Construction and Designing of UAV for Spraying Purpose in Sugarcane Plantations

Sarthak Patil¹, Arya Sawant²

U.G. Student, Department of Mechanical Engineering, KIT's College of Engineering, Kolhapur, Maharashtra, India¹

U.G. Student, Department of Electronics Engineering, KIT's College of Engineering, Kolhapur, Maharashtra, India²

ABSTRACT: Drone also called an unmanned aerial vehicle is an aircraft without a human pilot. Drones are operated by a control station on the ground. The communication between the drone and the ground control station is via the radio waves transmission between the two. The following is a drone dedicated to the agricultural application. The drone follows the instruction to form a remote or act based on the pre-programmed flight program to complete its operation. The proposed drone is a result of research done regarding solving the problem of farmers to spray pesticides and fertilizers on the perennial grass plantation and other hard to reach plantations. This agricultural drone has successfully executed the assignment of spraying 100 liters of pesticide over the field of 30000 acres within a specified amount of time. The drone acted upon the pre-programmed flight instructions given to it

KEYWORDS: Unmanned aerial vehicles, agricultural drone.

I. INTRODUCTION

Drone technology is an emerging area of interest in the field of science and innovation. The concept of officer drones where drones hover around crime scenes to gather evidence is already in use in the US to improve the speed of remote investigations and to solve crime through rapid response. In other fields, such as architecture, the drone is used to assess the overall design of a building during construction and final touches on buildings. However, drone technology is not yet used to address the problems faced by the farmers with tall perennial grass plantations such as sugarcane, also farmers with vineyards and small tree plantations.

Many problems are faced by the farmers under the suggested genre of plantations (sugarcane & maize) some of those problems are unwanted weeds growth around the plant, stems eating insects, roots eating parasitic plants, and many harmful bacteria as well. Other than these naturally occurring crop killers, farmers also face problems such as proper plant growth and sundry other problems. These problems are successfully being beaten by the use of pesticides for pest and insecticides for the stem eating insects, fertilizers being used to provide proper nutrients to the plants. However, these operations are hectic, time-consuming also spraying the proper amount of these chemicals is a crucial task. These activities are painstaking mainly because the grown crops are thick on the upper end and the soil beneath is sodden most of the time, due to continuous irrigation required by these plants and trees. Hence, the mobility between the corps is significantly reduced for the farmers. So, a proposed solution for this problem can be a flying vehicle (drone) that can do the job more efficiently and effectively. Because of the drone's airborne operation capabilities, the mobility limitation between the plantation is solved and the drone's low flight makes it possible to spray the pesticide and fertilizers between the plantation rows, precisely at the bottom of each plant. The whole operation is controlled by motors and pumps which are operated by the Arduino programmed with appropriate instructions. The precise control of the drone makes it possible for the farmer to complete the job in a highly effective manner.

II. RELATED WORK

[1] explains the importance of UAVs in precision agriculture which includes tasks like monitoring and supervision. Spraying of pesticides is a tedious task that can be made simpler with the use of intelligent robust technologies like UAV. [2] discusses different architectures based on UAV. The paper gives various ideas to reduce human efforts by using drones to detect pests and spraying fertilizers. [3] gives the detailed implementation of Agriculture drone for automatic spraying mechanism. In this paper, they gave the problem statement of the World Health Organization where it estimates that there are 3 million cases of pesticide poisons in each year and upto 220,000 deaths, primarily in developing countries. The model discussed in [5] is used to spray the liquid as well as solid contents in areas that difficult to access for farmers.

III. METHODOLOGY

The methods employed before designing the required drone are divided into the following phases:

Phase one:

In this phase, a study is carried out based on a questionnaire. It was done basically to connect with farmers to gather information. Interviews, observations were carried out for the same.

The question asked was:

Q. what problems do the farmers face while spraying fertilizers and insecticides in the sugarcane corps?

A. the answer from the majority of the farmers was the mobility, as the sugarcane plant leaves are the length and one plant has more than 40-50 leaves also, the rows of plantations are 2-5 feet apart which lead these plant leaves to cover the free space between the two consecutive rows making the mobility of framers fairly restricted.

Other than the mobility factor, the task of spraying is hectic and repetitive. Not to forget that the chemicals inside these fertilizers are harmful to health. Below is an image that depicts the narrow space between the plantation rows.



Figure 1: sugarcane plantation.

Phase two:

Data collected through research for possible drone design:

1. Drone width required: 2-3 feet wide.
2. Load-carrying capacity: 5-10 kg.
3. Hovering height required: 3-4 feet.
4. Attack speed range: 5-7 m/s.

+

Ideal conditions assumed before the design of the specific drone are:

- The plantation lanes/rows are straight.
- Sufficient spacing between each lane/row.
- Sufficient turning space at the end of each line/row.
- The average length of the sugarcane plant is well over 2 meters (which ultimately means the leafy part of the plant is above 1meter.

Phase three:

Drone designing

1. Fundamental Drone dynamics:

The drone configuration has six rotors that generate the propeller forces F_p ($p = 1, 2, 3, 4, 5, 6$) as shown in Fig. 2. The control of the drone is achieved by commanding different speeds of different propellers, which, in turn, produces differential aerodynamic forces and moments. In order to increase the altitude of the aircraft, it is necessary to increase the rotor speeds all together by the same amount [4, 6, 13].

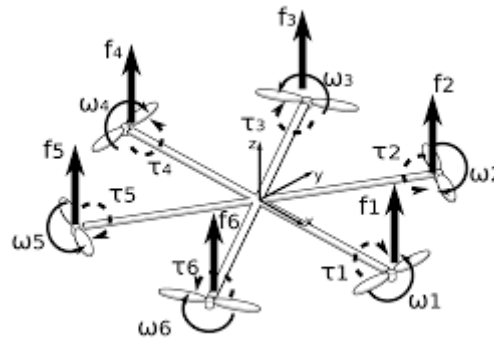

Each rotor consists of a brushless DC motor and a fixed-pitch propeller. This drone consists of three rotors that rotate clockwise 1, 3, 5, and three that rotate counter-clockwise 2, 4, 6. Forward motion is accomplished by increasing the speed of rotors 3, 4, 5, while simultaneously reducing the same value for forward 1, 2, 6. For leftward motion, the speed of rotors 5 and 6 is increased, while the speed of rotors 2 and 3 is reduced. Backward and rightward motion can be accomplished in a similar fashion. Finally, yaw motion can be performed by accelerating or decelerating the clockwise rotors, depending on the desired angle direction [4, 6,1,3].

Mass estimation:

In order to calculate the thrust required by the motor + propeller to lift the given load, the total mass of the drone must be estimated first, then using this data static thrust can be calculated.

Table 2: Weight estimation for each part.

Part	Average Weight (gm)	No. required	Final average weight (gm)
Frame	800 (approx.)	1	800
Screws, standoffs, wires (est.)	70	1	70
Arduino UNO.	27.6	1	27.6
Sonar and IR sensor	7+6	1+1	13
ESC	40	6	240
Motor	120	6	700
Water pump	60	1	60
Propellers	14	6	84
Propeller duct (approx.)	5	6	30
Battery	300	1	300
Carrier tank	2000	1	2000

Total weight (g)
4000(approx.)

Static thrust calculation:

$$\text{Power} = \text{prop. Const.} \cdot \text{rpm}^{\text{power factor}} \dots\dots\dots (1)$$

Here, the power is in watts and rpm is in thousand.



Table (3): ideal rpm for APC propellers from momentum theory calculations.

Ideal Thrust (mass kg)	Propeller	Diameter (m)	PC	PF	Ideal rpm
1.166	6x4	0.1524	0.015	3.2	8320
	7x5	0.1778	0.042	3.2	5747
Air Density [kg/m ³] 1.225	8x4	0.2032	0.06	3.2	4931
	8x6	0.2032	0.106	3.2	4127
	8x8	0.2032	0.148	3.2	3719
Gravity [m/s ²] 9.81	9x4.5	0.2286	0.09	3.2	4187
	9x6	0.2286	0.129	3.2	3741
	9x7.5	0.2286	0.352	2.9	3034
	9x9	0.2286	0.448	2.9	2792
	10x5	0.254	0.144	3.2	3498
	10x7	0.254	0.223	3.2	3051
	10x10	0.254	0.68	2.9	2331
	11x5.5	0.2794	0.222	3.2	2966
	11x7	0.2794	0.301	3.2	2697
	11x8	0.2794	0.357	3.2	2557
	11x8.5	0.2794	0.383	3.2	2501
11x10	0.2794	0.589	3.2	2186	

Then obtaining thrust by using moment theory we get,

$$T = (\pi/4) * D^2 * \rho * v * \delta v \dots\dots\dots (2)$$

Here,

T= thrust [N].

D= propeller diameter[m].

v= velocity of air at the propeller [m/s].

δv =velocity of air accelerated by the propeller [m/s].

ρ = density of air[1.225 kg/m³].

Using common rule for the velocity of air at the propeller is $v = \frac{1}{2} \delta v$ and solving equation (2) for power we get,

$$T = [(\pi/2) * D^2 * \rho * P]^{\frac{1}{3}}$$

Again, solving it for mass we get,

$$M = [(\pi/2) * D^2 * \rho * P]^{\frac{1}{3}} \div g \dots\dots\dots(3)$$

$$M * g^3 / (3.14/2 * D^2 * \rho)$$

Where,

g= 9.81 m/s².

And P= power [watts].

Now, as we have a limiting factor i.e. the width of the row of plantation=2-3 feet or max. 60cm we have to select a propeller with a maximum diameter of 25cm or 10inch.

putting the values in equation (3) and solving for power required by each motor-propeller

We get,

$$P = 114 \text{ Watts} \dots\dots\dots (4)$$

This is the least total power that should be produced by each of the 6 motors in order to achieve hovering.

2. Construction of frame:

The frame of a drone has to be rugged while being light enough to take flight. When all of the available materials are taken into consideration, carbon fiber proves to be the most effective material for a frame due to its low density and high strength. The design of the frame is intentionally made simplistic to avoid any bulking of the frame and easy assembly. Silicon adhesive and epoxy are used to stick all the parts together strengthened by a bunch of screws. The Carrier tank is attached at the bottom. The tank has a 2L capacity.

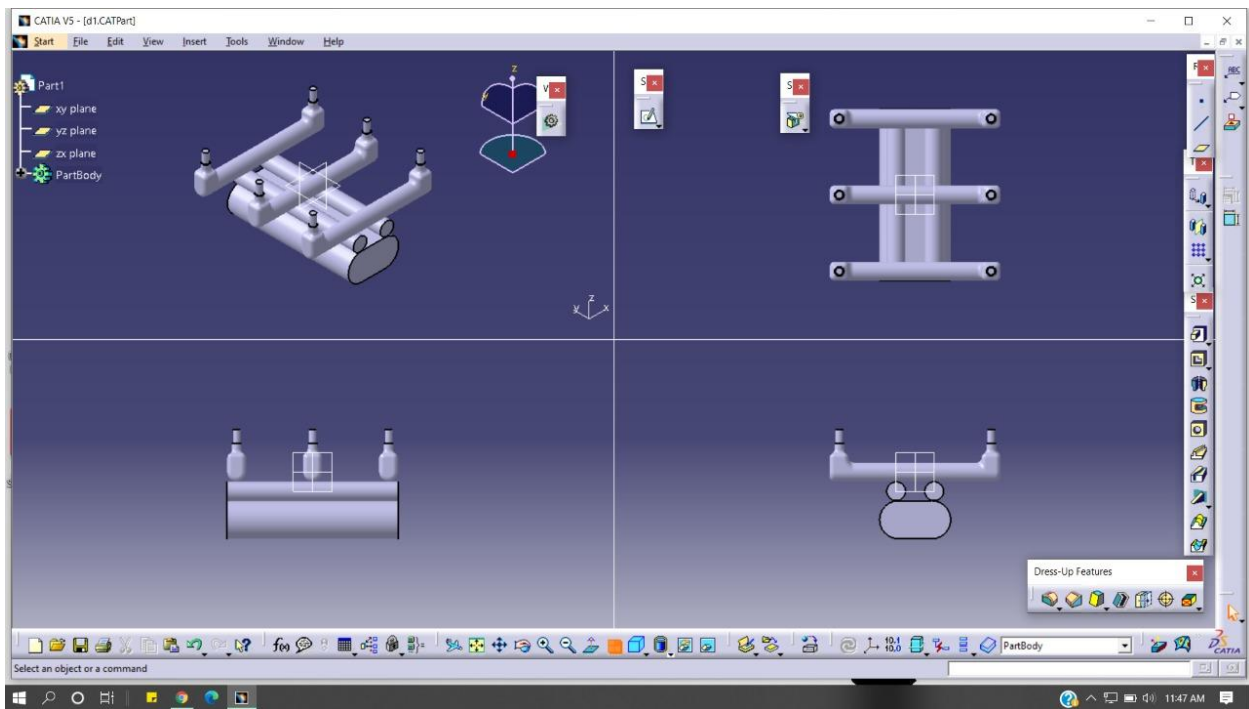

Figure 2: Drone design.

2. Propeller and motor selection.

Referring to the table (3) and selecting a 10x5 propeller.

We have,

Propeller constant=0.144

Power factor=3.2

Diameter(m)=0.254.

Ducted propellers:

Ducts are used to improve the efficiency of the propeller and are especially used on heavily loaded propellers or propellers with limited diameter, Also the duct help in reducing the vortices at the tip of the propeller which might interfere with the consecutive propellers flight.

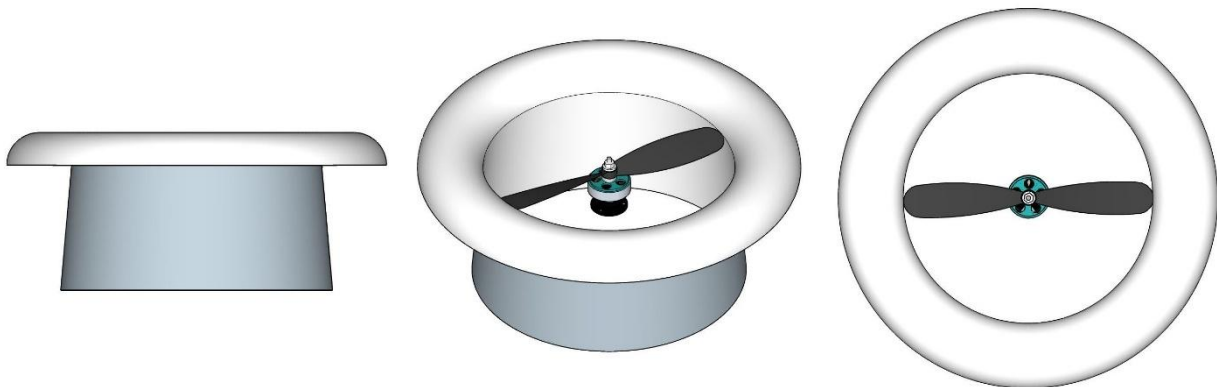
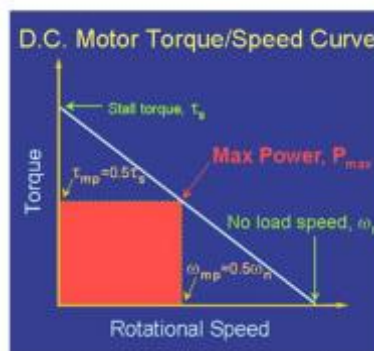

Figure 3: ducted propeller design.

Here, we have limited space between plantations and the duct will protect the propellers from any debris or external agent from hampering the drone’s flight. Hence, we have used ducted propellers for a smooth flight operation.

While selecting the motor we have to calculate the ideal rpm requirement and finally the kV rating of the required motor.

1. Putting propeller values in equation (1) and solving for rpm.
 Taking power=114watts (from (4))
 Ideal rpm=3498. From table.



In order to find the maximum power of a motor, all that is needed is to find the rotational speed at which the maximum power occurs. It is shown in Figure above that maximum power is achieved at torque and rotational speed that is half of the motor’s maximum capabilities given a constant voltage.

So,

Ideal rpm= ½ x max. rpm produced by the motor.

Max. rpm = 2x ideal rpm = 6102.

Also,

Max. rpm of the motor per volt = kV rating of motor x voltage

kV rating = 1400, considering a 3S battery with 11.1 voltage.

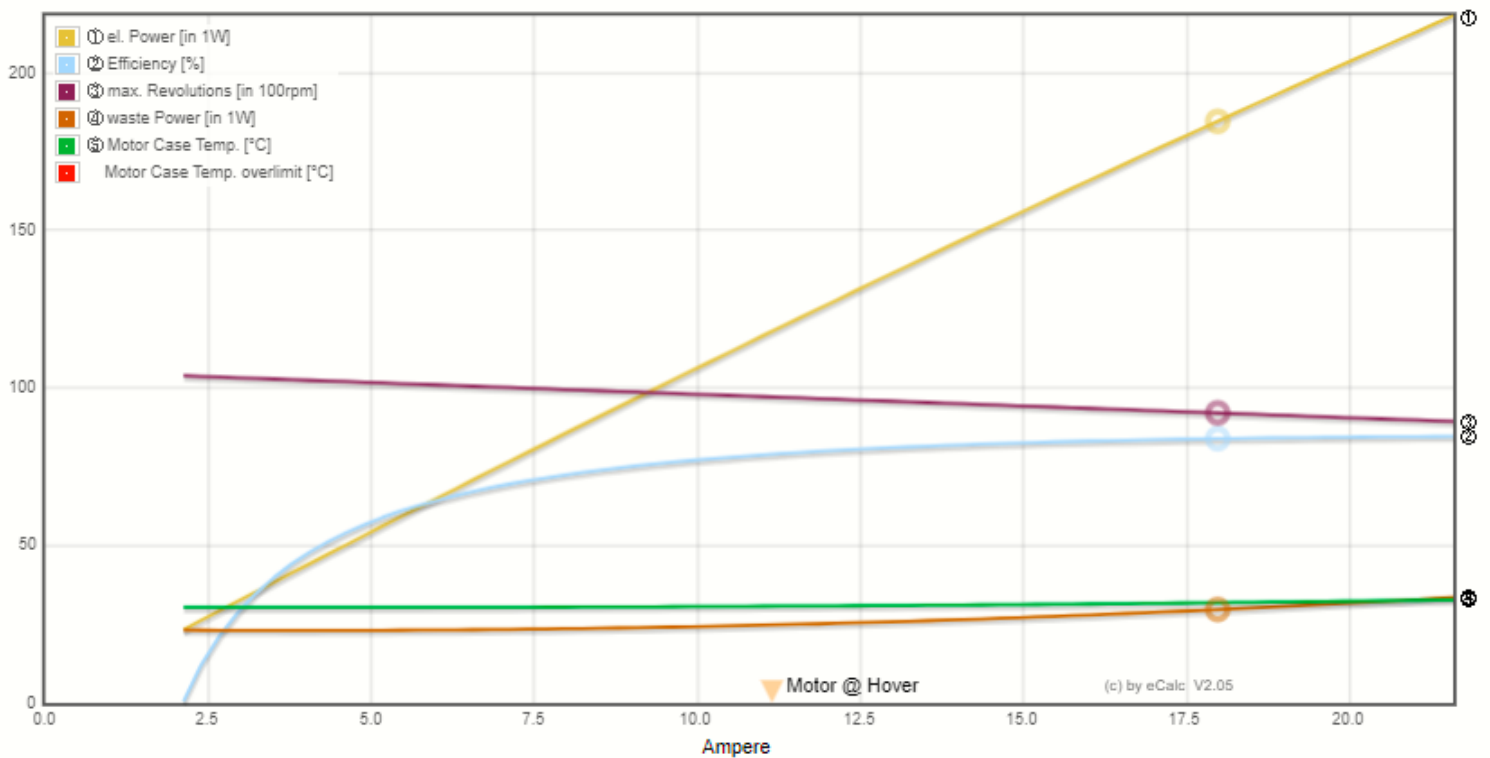

figure 4: motor characters during full throttle.

Battery and flight time:

The most commonly used battery is Li-po batteries. They have a large capacity, lightweight, and excellent discharge capabilities. The following is general information about LiPo batteries:

- Each cell of a LiPo battery has a nominal voltage of 3.6 volts and is fully discharged when each cell reaches 3.0 volts, and a battery usually contains 1 to 3 cells. (NB: discharging a LiPo battery below 3V/cell will make it un-chargeable.)
- Current is rated in C's which is the maximum discharge rate of a battery. For example, a 1C battery can handle a current that would take an hour to fully discharge and a 2C battery is capable of being discharged in ½ an hour.
- The capacity of a battery is rated in milliamp-hours (mAh).

Flight time, which is directly proportional to battery capacity, can be found by dividing battery capacity by the amount of current being drawn from the battery.

Flight time= battery capacity/amps.

Battery description:

Capacity: Orange 8000mAh.

Nominal voltage: 11.1V.

Configuration: 3S1P

Discharge rate: 30C.

Maximum burst discharge rate: 45C.

The flight time below is possible with Turnigy G15-950 Brushless Motor.



Flight time = 6.1 min.

So, the drone will fly for 6.1 min at 50% discharge. The time is appropriate according to the rate of spraying i.e. the pump will utilize the 2L tank in approximately 2 minutes.

IV. EXPERIMENTAL RESULTS

Following results are observed during the trial period of the fully functional drone:

1. Flight time achieved = 6.1 min.
2. Total current drawn is 20 amps= motor current (18 amps)+pump current (2 amps).
3. Specific trust obtained is 5.64 g/W.
4. Thrust to weight ratio = 1.3 (enough to lift the drone to the required height.)

{the following result can be observed in the drone report in figure 5 below. Also, the estimated range of the drone is shown in figure 6.}

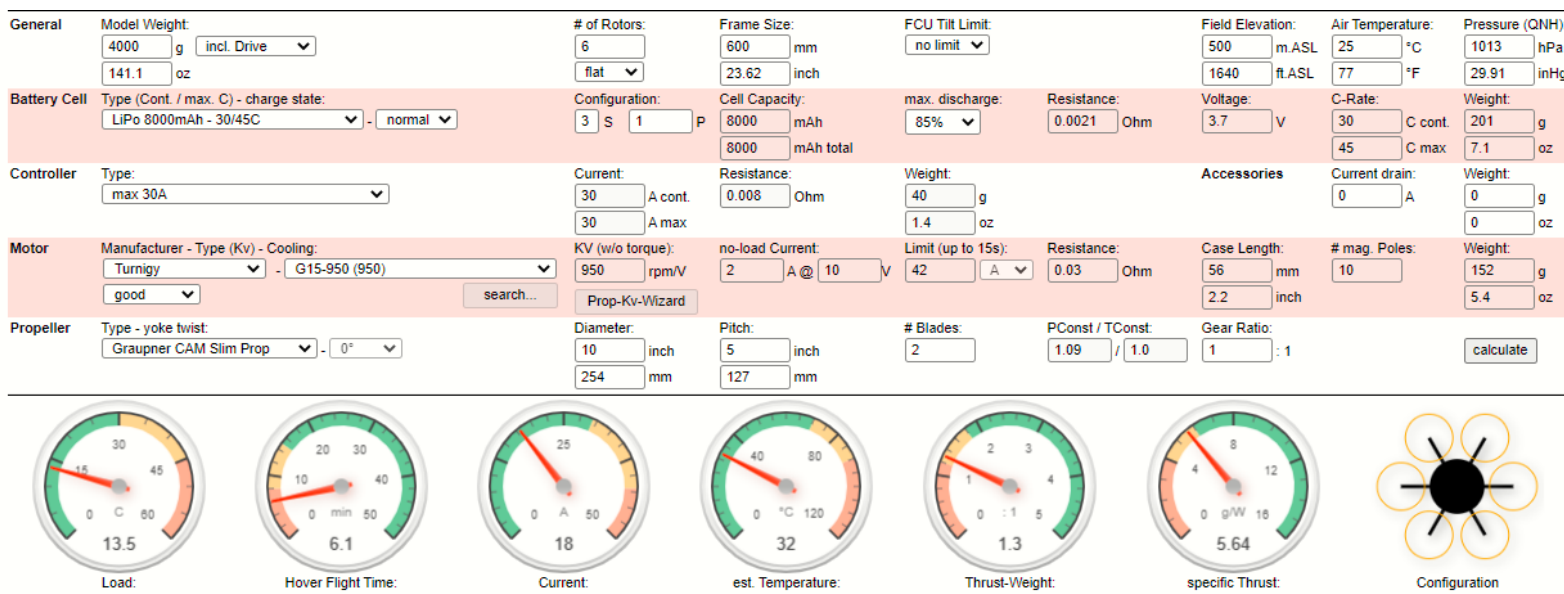

figure 5: drone performance report.

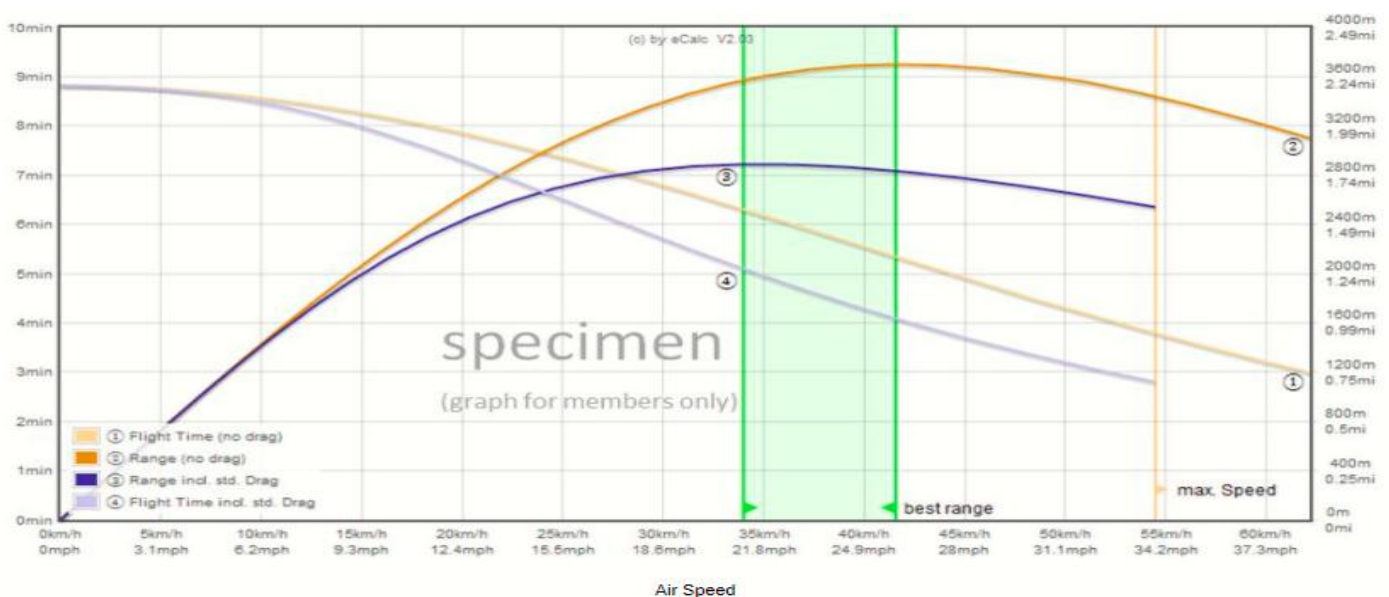

Figure 6: estimated range.

V. CONCLUSION

The drone is capable of carrying out the coordinated assignment of spraying the pesticide. Following are the specifications of the trial environment:

1. The area selected was 30000 sq. feet.
2. Length of one row= approx. 200 feet.
3. Total number of rows = approx. 50

Human operation results:

1. Total time taken to complete the spraying operation (including tank refilling time) = 3 hours.
2. Total mixture volume (pesticide + water) required to completely spray over 30000 sq. feet = 150L.
3. Amount of pesticide required for each row = 3L.

Drone operation results:

1. Total time (including tank refilling time and considering the operator has charged set of power sources i.e. battery to replace at each interval of 6.1 min) = 50-60 min.
2. Total mixture volume (pesticide + water) required to completely spray over 30000 sq. feet = 100L.
3. Amount of pesticide required for each row = 2L (capacity of 1 tank of the drone.)

Looking at the result of the human operation and drone operation and comparing, it is apparent that the drone has done the operation within 1/3rd of the time taken by the human. Also, the total amount of pesticide required for the whole operation is less during the drone operation. This concludes that employing this exclusive unmanned aerial vehicle for spraying operation can prove more effective and efficient than the human mode of operation.

REFERENCES

1. George IPATE, Gheorghe VOICU, Ion DINU, "RESEARCH ON THE USE OF DRONES IN PRECISION AGRICULTURE", U.P.B. Sci. Bull., Series D, Vol. 77, Iss. 4, 2015.
2. S.R.Kurkute, B. D. Deore, Payal Kasar, Megha Bhamare, Mayuri Sahane, "Drones for Smart Agriculture: A Technical Report", International Journal for Research in Applied Science & Engineering Technology (IJRASET), Volume 6 Issue IV, April 2018
3. Prof. P. P. Mone, Chavhan Priyanka Shivaji, Jagtap Komal Tanaji, Nimbalkar Aishwarya Satish "Agriculture Drone for Spraying Fertilizer and Pesticides", International Journal of Research Trends and Innovation, (ISSN 2456-3315, Volume 2, Issue 6). September 2017.
4. Prof. K. B. Korlahalli, Mazhar Ahmed Hangal, Nitin Jituri, Prakash Francis Rego, Sachin M. Raykar, "An Automatically Controlled Drone Based Aerial Pesticide Sprayer", Project Reference No.39S_BE_0564
5. S. Meivel M.E, Dr. R. Maguteeswaran Ph.D., N. Gandhiraj B.E, G. Sreenivasan Ph.D., "Quadcopter UAV Based Fertilizer and Pesticides Spraying System", International Academic Research Journal of Engineering Sciences, ISSN No. 2414-6242, Volume 1, Issue 1, February 2016



INNO SPACE
SJIF Scientific Journal Impact Factor

**Impact Factor:
7.512**

ISSN INTERNATIONAL
STANDARD
SERIAL
NUMBER
INDIA



INTERNATIONAL JOURNAL OF INNOVATIVE RESEARCH

IN SCIENCE | ENGINEERING | TECHNOLOGY

 9940 572 462  6381 907 438  ijirset@gmail.com



www.ijirset.com

Scan to save the contact details