

# International Journal of Innovative Research in Science, Engineering and Technology

(A High Impact Factor, Monthly, Peer Reviewed Journal)

Visit: [www.ijirset.com](http://www.ijirset.com)

Vol. 9, Issue 1, January 2020

## Intelligent Vigilant Stove for Home Safety Using IOT

Sahil Kalpesh Desai

Student, Class X - Narayana e-Techno School, Borivali West, Mumbai, India

**ABSTRACT:** Frequently, people forget to turn OFF stoves which can lead to fire accidents. According to available data, several fire accidents take place each day due to domestic gas leakage. To prevent this, I have designed an IoT based smart stove, which contains sensors, display unit, buzzers and LED for indication. This model has knob lock that opens only when a vessel is placed atop the stove. The stove is equipped with a gas detector is installed in the stove that senses the presence of the gas, LED displaying whether the gas is on or off, smoke sensor, PIR sensor and a wi-fi that can alert you and others if the gas remains on while you are away, enabling you to take immediate action to avoid fire accidents.

**KEYWORDS:** Arduino, ultrasonic sensor, PIR sensor, gas detector, IoT, servo motor, I2C LCD

### I.INTRODUCTION

The kitchen is the most important room in our home as it is the center of every family's day-to-day living. Everyone's day mostly begins in their kitchen with a cup of coffee and / or with energizing breakfast to start their day. Everyone deserves a tranquil environment to cook food and to begin their days or to end their days. But a kitchen is incomplete without a stove, as it is an element which is the most important to cook anything.

There is a simple proverb, "Life cannot go on without forgetting." Frequently people forget to turn OFF their stoves and here's where the story begins.....

According to available data, in the USA, about 357,000 house-fires take place each year. That means one house-fire every 85 seconds. These house-fires cause almost 13,000 injuries per year and 7 deaths every day and the cooking instruments are the common cause of such house fires. While no such organized data seem to be available in India; here too, most fire accidents take place due to gas leakage and cylinder bursts.

To address this challenge with the use of technology, we have designed a smart stove, which contains sensors and electronics. We have designed a prototype which brings a solution to this every day problem.

In this prototype, the gas knob will be locked initially until we place a vessel on top of the stove. Only when we place a vessel on the top of the stove, the knob gets unlocked and gas can be turned ON.

Then, there is a gas detector which senses the presence of the gas and turns on the L.E.D. This will be a reminder for you that the gas is ON. Also, whether the knob is locked or unlocked, and whether the gas is ON or OFF will be displayed on an L.C.D.

There are additional safeguards that we have built in. There is a PIR Sensor, which detects personal movement in and around the stove. If the gas is ON and if there is no movement detected for say five minutes and a buzzer will set off. If after another five minutes, no movement is still detected, a notification will be sent to your phone using IoT.

# International Journal of Innovative Research in Science, Engineering and Technology

(A High Impact Factor, Monthly, Peer Reviewed Journal)

Visit: [www.ijirset.com](http://www.ijirset.com)

Vol. 9, Issue 1, January 2020

## II. IMPLEMENTATION

### BLOCK DIAGRAM:

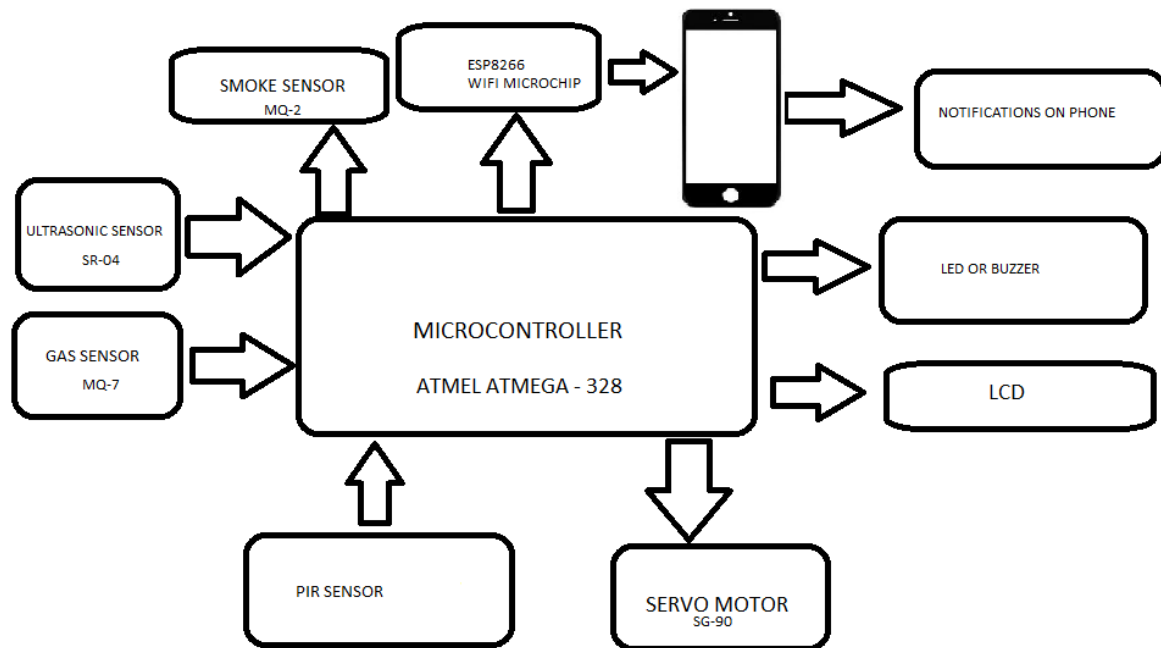

## III. BACKGROUND

There are two different types of stoves in the market currently. The induction stoves and the LPG stoves. The induction stoves are much better and safer than the LPG stoves but they require electricity, which is very difficult to obtain all through. Because of this most people still use LPG stoves. The Indian Government recently made a significant push in this regard offering numerous LPG connections to economically poor and disadvantaged people. However, LPG stoves come with their own risks and are not as safe as induction stoves. Keeping this in mind, I thought of a better and safer LPG stove.

# International Journal of Innovative Research in Science, Engineering and Technology

(A High Impact Factor, Monthly, Peer Reviewed Journal)

Visit: [www.ijirset.com](http://www.ijirset.com)

Vol. 9, Issue 1, January 2020

## IV.MECHANICAL STRUCTURE

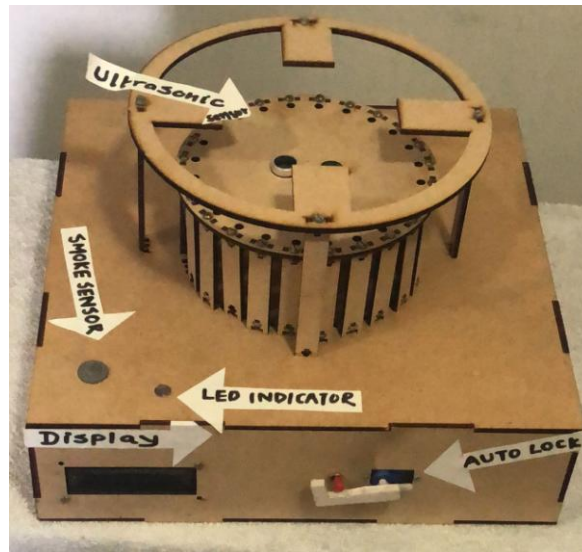

To make this prototype look good, I have used mdf material (medium density fibre). Designed by coral draw and then laser cut.

## V. ELECTRICAL COMPONENTS

In this research project, a microcontroller based embedded system is designed and interfaced with the mechanical structure. This embedded system consists of an Arduino UNO, ultrasonic sensor SR-04, servo motor SG-90, Wi-Fi microchip ESP8266, smoke sensor MQ-2, gas sensor MQ-7, I2C 16x2 LCD, LED, buzzers.

### Arduino Uno:



Arduino is an open source computer hardware and software company, project, and user community that designs and manufactures single-board microcontrollers and microcontroller kits for building digital devices and interactive objects that can sense and control objects in the physical and digital world. Arduino Uno is a microcontroller board based on the ATmega328P. It has 14 digital input / output pins (of which 6 can be used as PWM outputs), 6 analog inputs, a 16 MHz quartz crystal, a USB connection, a power jack, an ICSP header and a reset button.

## International Journal of Innovative Research in Science, Engineering and Technology

(A High Impact Factor, Monthly, Peer Reviewed Journal)

Visit: [www.ijirset.com](http://www.ijirset.com)

Vol. 9, Issue 1, January 2020

### Ultrasonic sensor (SR-04):



As the name indicates, ultrasonic sensors measure distance by using ultrasonic waves.

The sensor head emits an ultrasonic wave and receives the wave reflected back from the target. Ultrasonic Sensors measure the distance to the target by measuring the time between the emission and reception.

### Wi-Fi microchip (ESP8266):

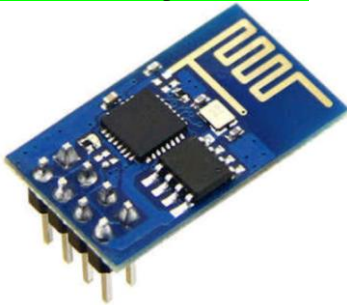

The ESP8266 is a low-cost Wi-Fi microchip with full TCP/IP stack and micro-controller capability that can be programmed using the Arduino IDE. The ESP8266 is also capable of running its own web server, which we will be using in this project for communicating with the Wi-Fi module.

### Smoke sensor (MQ-2):



Smoke / Gas Sensor (MQ-2) module is useful for gas leakage detection (home and industry). It is suitable for detecting H<sub>2</sub>, LPG, CH<sub>4</sub>, CO, Alcohol, Smoke or Propane. Due to its high sensitivity and fast response time, measurement can be taken as soon as possible. The sensitivity of the sensor can be adjusted by potentiometer.

## International Journal of Innovative Research in Science, Engineering and Technology

(A High Impact Factor, Monthly, Peer Reviewed Journal)

Visit: [www.ijirset.com](http://www.ijirset.com)

Vol. 9, Issue 1, January 2020

### Gas sensor (MQ-7):



The MQ-7 is a Carbon Monoxide (CO) sensor suitable for sensing CO concentrations in the air. It can detect CO-gas concentrations anywhere from 20 to 2000 ppm. It makes detection by cycling high and low temperature, and detects CO at low temperature. It is widely used in domestic CO gas leakage alarm, industrial CO gas alarm and portable CO gas detector.

### PIR sensor:



Typical residential/commercial PIR-based motion detector (PID). A passive infrared sensor (PIR sensor) is an electronic sensor that measures infrared (IR) light radiating from objects in its field of view.

### I2C LCD:



I2C LCD is an easy-to-use display module, it can make display easier. Using it can reduce the difficulty of make, so that makers can focus on the core of the work.

**Servo Motor:**



A servomotor is a rotary actuator or linear actuator that allows for precise control of angular or linear position, velocity and acceleration. It consists of a suitable motor coupled to a sensor for position feedback. It also requires a relatively sophisticated controller, often a dedicated module designed specifically for use with servomotors.

## VI. CIRCUIT DIAGRAM

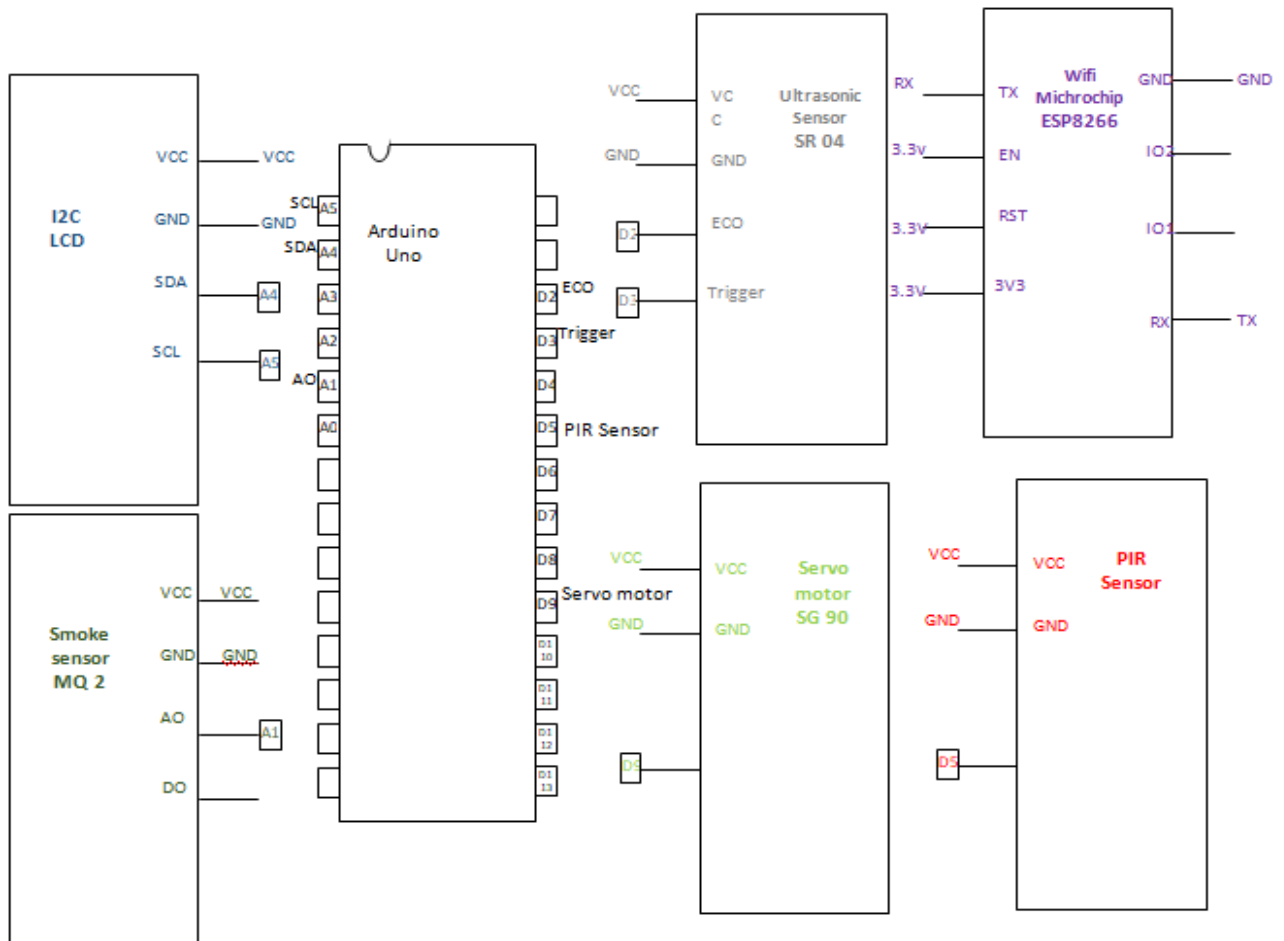

# International Journal of Innovative Research in Science, Engineering and Technology

(A High Impact Factor, Monthly, Peer Reviewed Journal)

Visit: [www.ijirset.com](http://www.ijirset.com)

Vol. 9, Issue 1, January 2020

## VII. FLOW CHART

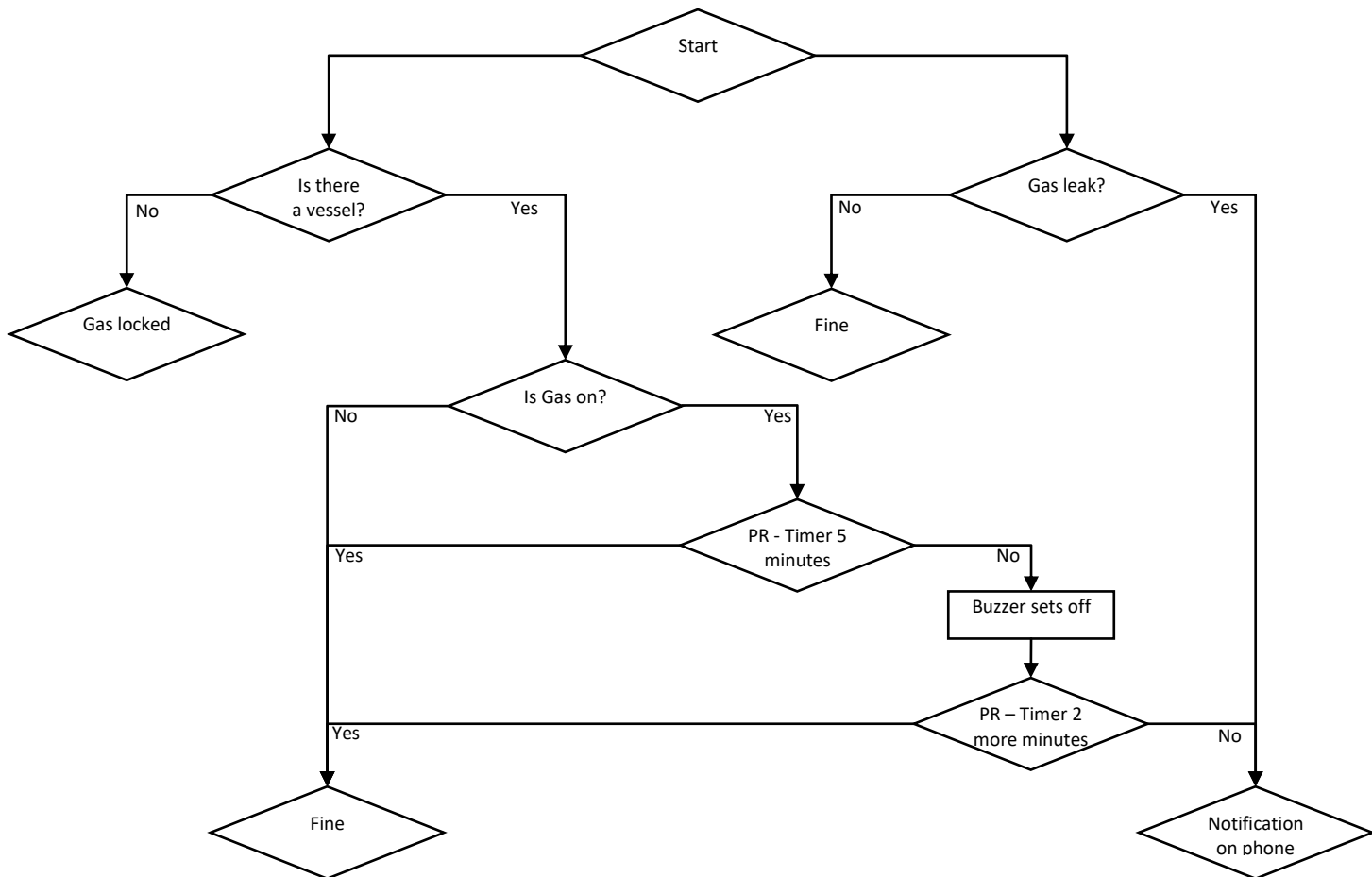

# International Journal of Innovative Research in Science, Engineering and Technology

(A High Impact Factor, Monthly, Peer Reviewed Journal)

Visit: [www.ijirset.com](http://www.ijirset.com)

Vol. 9, Issue 1, January 2020

## VIII. RESULTS

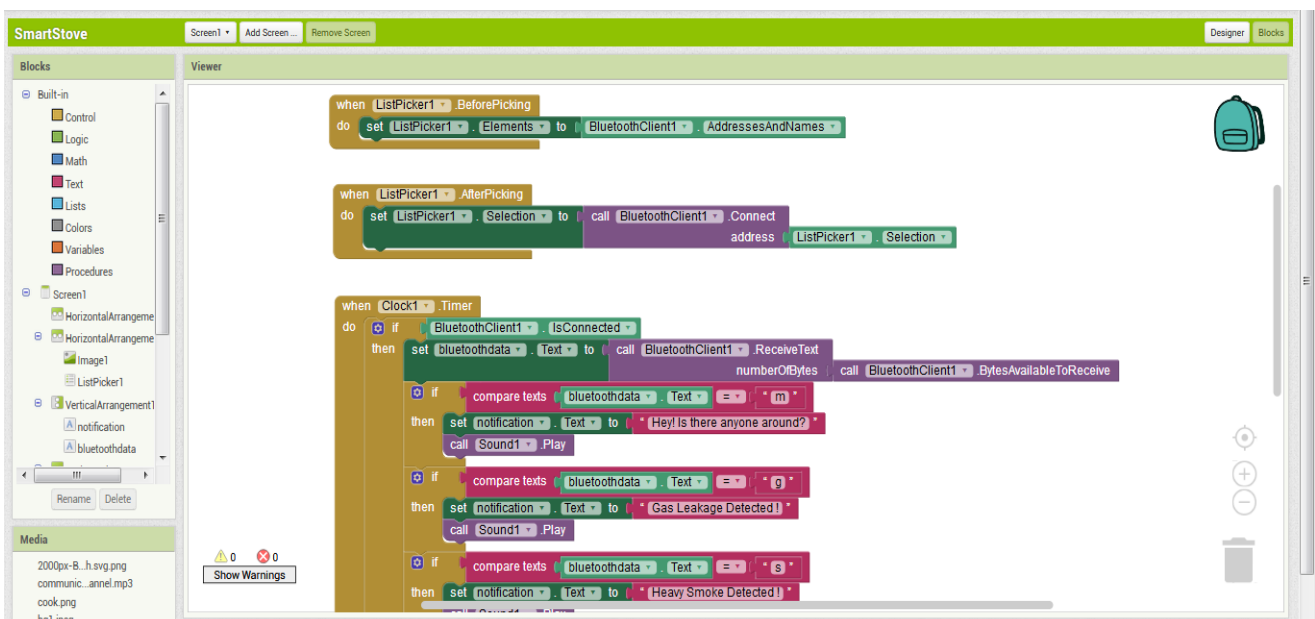
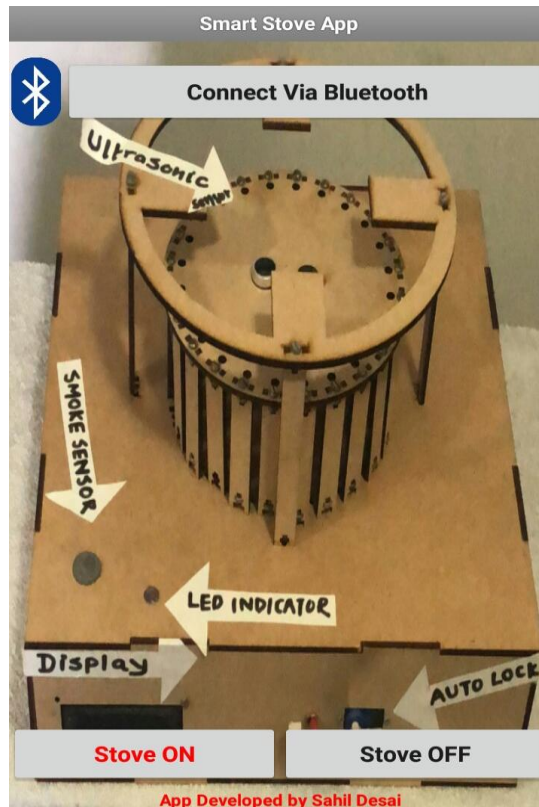



# International Journal of Innovative Research in Science, Engineering and Technology

(A High Impact Factor, Monthly, Peer Reviewed Journal)

Visit: [www.ijirset.com](http://www.ijirset.com)

Vol. 9, Issue 1, January 2020

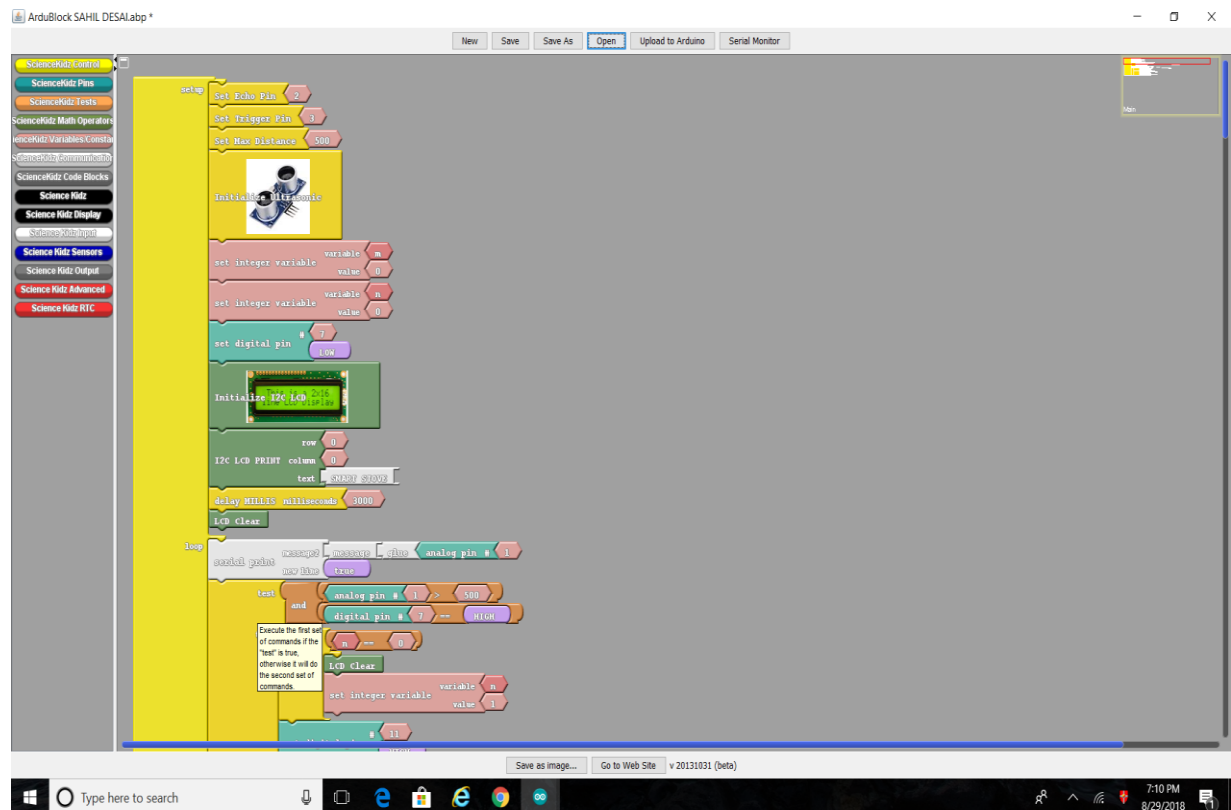
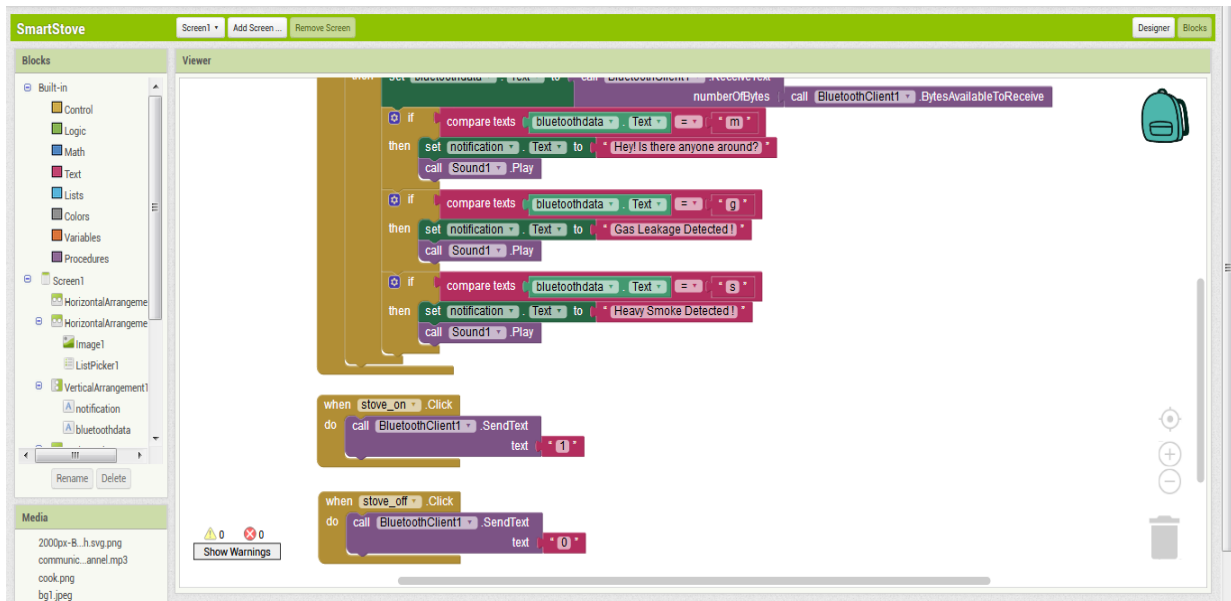

# International Journal of Innovative Research in Science, Engineering and Technology

(A High Impact Factor, Monthly, Peer Reviewed Journal)

Visit: [www.ijirset.com](http://www.ijirset.com)

Vol. 9, Issue 1, January 2020

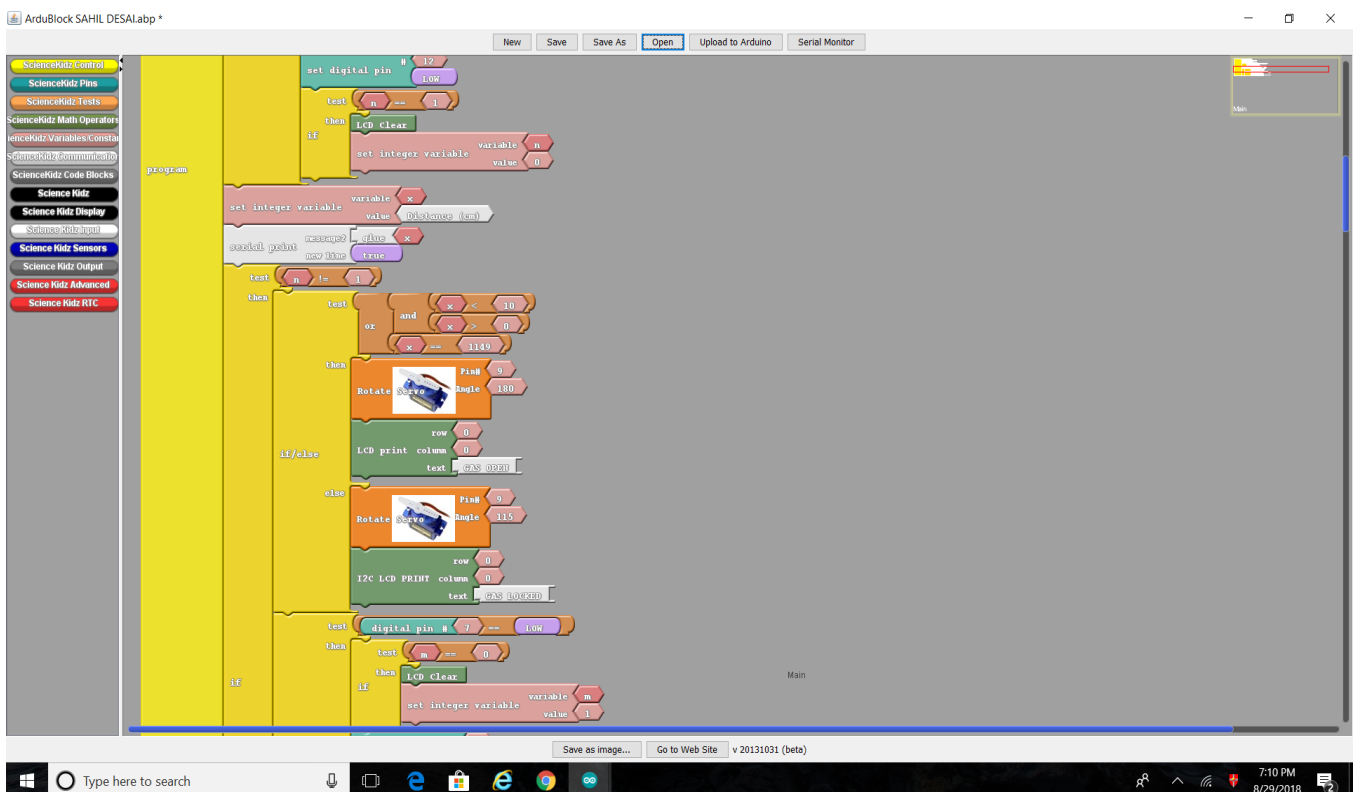
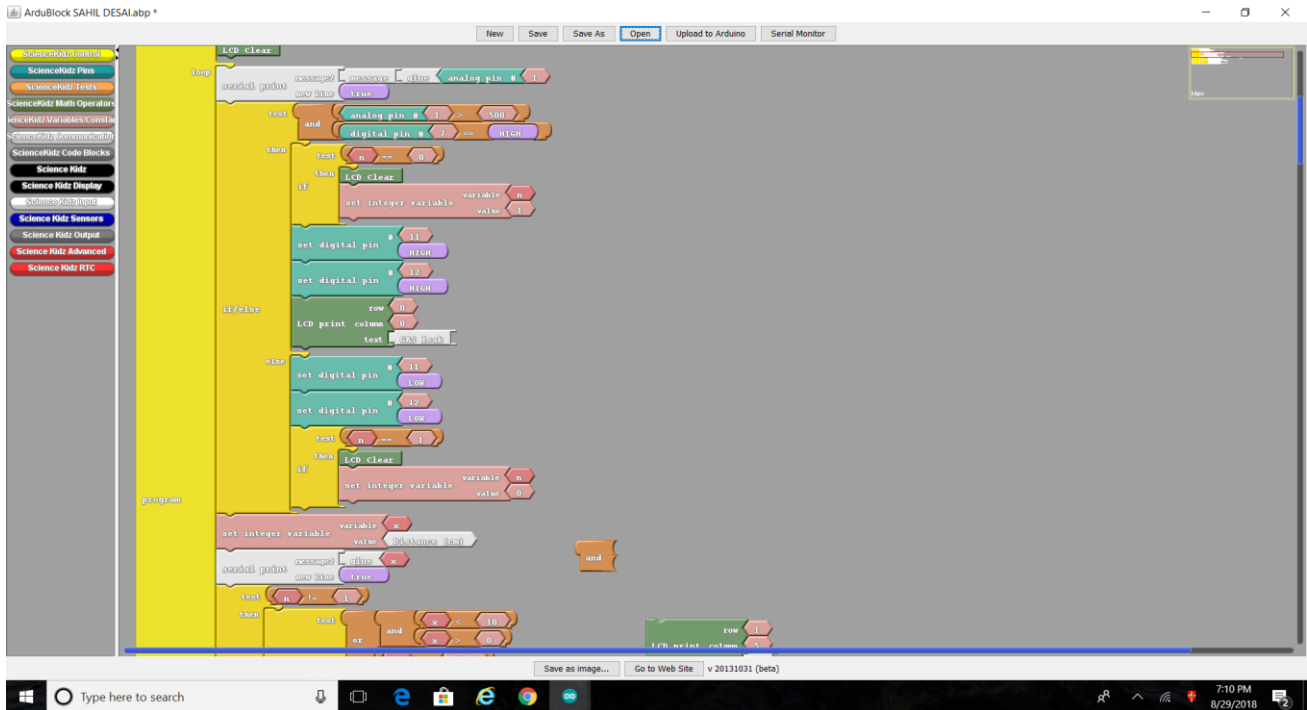

# International Journal of Innovative Research in Science, Engineering and Technology

(A High Impact Factor, Monthly, Peer Reviewed Journal)

Visit: [www.ijirset.com](http://www.ijirset.com)

Vol. 9, Issue 1, January 2020

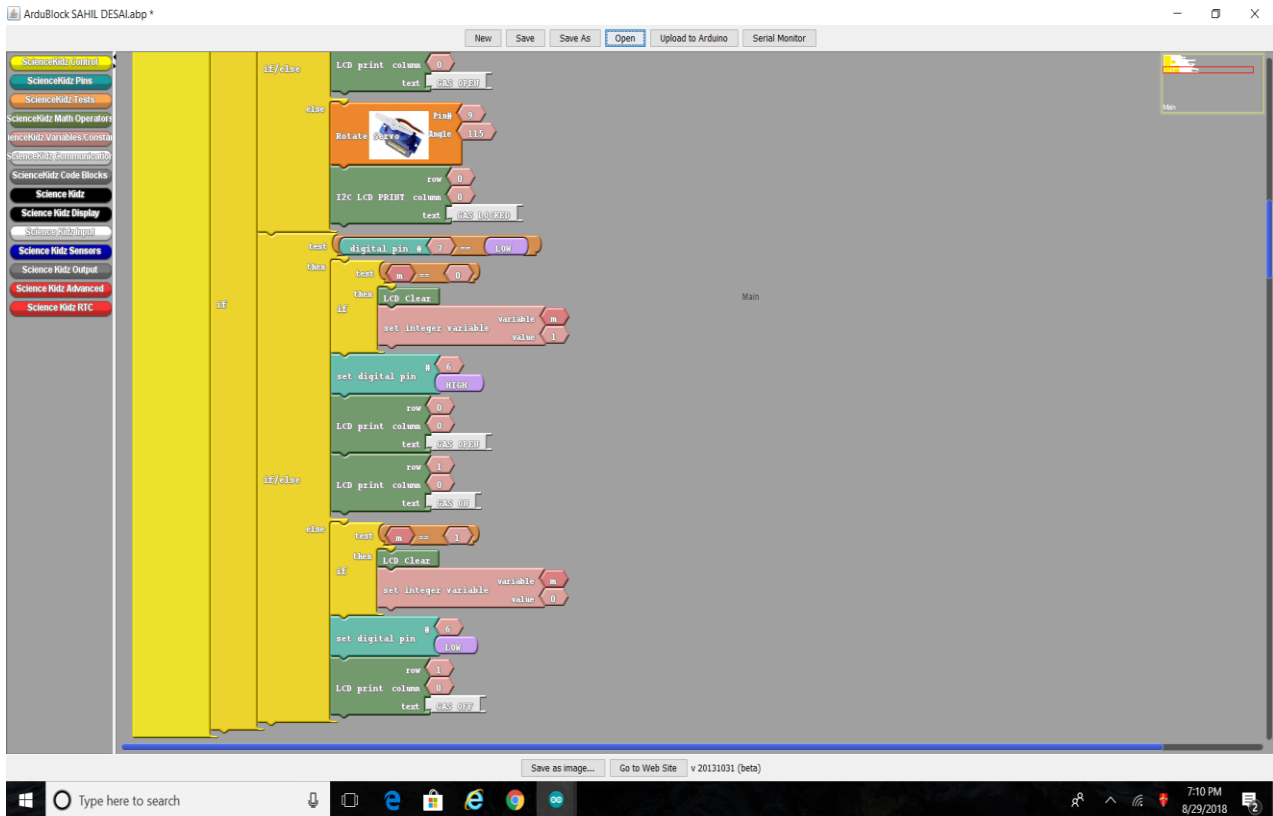

## REFERENCES

- [1] <http://www.iosrjournals.org/iosr-jeec/Papers/Conf.17017/Volume-3/13.%2082-87.pdf>
- [2] <https://www.arduino.cc>
- [3] [https://www.researchgate.net/publication/287878645\\_Internet\\_of\\_Things\\_and\\_its\\_role\\_in\\_Smart\\_Kitchen](https://www.researchgate.net/publication/287878645_Internet_of_Things_and_its_role_in_Smart_Kitchen)
- [4] <http://www.ijrat.org/downloads/ncpci2016/ncpci-43.pdf>
- [5] [https://www.dfrobot.com/wiki/index.php/Carbon\\_Monoxide\\_Gas\\_Sensor\(MQ7\)\\_\(SKU:SEN0132\)](https://www.dfrobot.com/wiki/index.php/Carbon_Monoxide_Gas_Sensor(MQ7)_(SKU:SEN0132))
- [6] <https://learn.adafruit.com/pir-passive-infrared-proximity-motion-sensor?view=all>

## BIOGRAPHY



**Name:** Sahil Kalpesh Desai

**Affiliation:** Student, Class X, Narayana e-Techno School, Borivali West, Mumbai, India.

**Interest Area:** Mathematics, Robotics, Programming, Ethical hacking.

**Ambition:** Learn to be able to give wings to my innovative ideas which could solve several trivial problems that we face today.