

Design and Static Analysis of Master Rod Using Structural Steel A36 and Aluminium T6 6061

Sagar S R¹, Srikanth KM², Kotresh U³, Kari Ramakrishna⁴ Dr. A. Hareesh⁵

Assistant professor, Department of Mechanical Engineering, Amruta Institute of Engineering and Management Sciences, Bidadi, Karnataka, India^{1,2,3,4},

Professor, Department of Mechanical Engineering, Amruta Institute of Engineering and Management Sciences, Bidadi, Karnataka, India⁵

ABSTRACT: In a radial engine, the piston in one cylinder in each row is connected to the crank shaft by a master rod. The master rod assists the connecting link between the piston pin and the crank pin. The crank pin end contains the master rod bearing. The present work explains design and analysis of master rod. At present master rod is manufactured by using Forged steel material. In the present work 2D drawing is drafted based on calculations. A Parametric model of master rod is modelled using CATIA V5 R20 software and static analysis is carried out by using the ANSYS 14.5 software. FEA of master rod is carried out by considering two different materials like SSA36 and AIT66061. The better comparison was performed in the present analysis for various parameters like Equivalent Stress, Total Deformation, Fatigue life, Fatigue Damage and Factor of Safety were done in ANSYS 14.5 software. Also, Comparison between the SS A36 and Al T6 6061 for different parameters were carried out for different rotational velocity (RPM).

KEYWORDS: ANSYS 14.5, CATIA V5 R20, SS A36, Al T6 6061, static.

NOMENCLATURE

A = Area of cross section of the master, L = Stroke Length of the master rod, D = Diameter of the Piston, r = radius of the crank, w_{cr} = Buckling load, SS = Structural Steel, Al = Aluminium = Angular speed, θ = Crank Angle of Dead Centre, I_{x-x} = Moment of Inertia of the I – Section about the x -axis, I_{y-y} = Moment of Inertia of the I – Section about the y -axis, k = Radius of gyration.

I. INTRODUCTION

The radial engine is a reciprocating type internal combustion engine configuration in which the cylinders radiate outward from a central crankcase like the spokes of a wheel. It resembles a stylized star when viewed from the front, and is called a star engine. The radial configuration was commonly used for aircraft engines before gas turbine engines became predominant. Since the axes of the cylinders are coplanar, the connecting rods cannot all be directly attached to the crankshaft unless mechanically complex forked connecting rods are used, none of which have been successful. Instead, the pistons are connected to the crankshaft with a master and articulating-rod assembly. One piston, the uppermost one in the animation, has a master rod with a direct attachment to the crankshaft. The remaining pistons pin their connecting rods' attachments to rings around the edge of the master rod. Extra "rows" of radial cylinders can be added in order to increase the capacity of the engine without adding to its diameter. Four radials have an odd number of cylinders per row, so that a consistent every-other-piston firing order can be maintained, providing smooth operation. The radial engine normally uses fewer cam lobes than other types. As with most four-strokes, the crankshaft takes two revolutions to complete the four strokes of each piston.

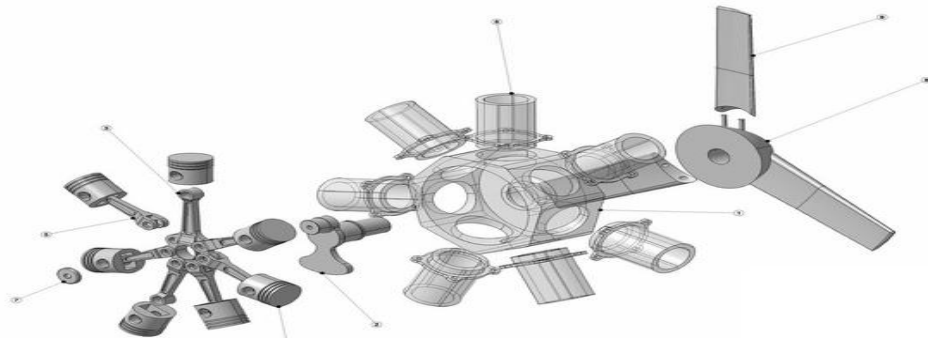

Fig 1.1: Radial Engine 3D Exploded View

II. SPECIFICATION OF THE PROBLEM

The objective of the present work is to design and analysis of master rod made of Structural Steel A36 and Aluminium T6 6061. Master rods are usually manufactured by the materials like steel. Master rod was modelled in CATIA V5 R20. Then Model is imported to ANSYS 14.5 for analysis. After analysis a comparison is made between Structural Steel A36 and Aluminium T6 6061 in terms of stress distribution, Total deformation, Fatigue life, Fatigue Damage and Safety factor.

III. DESIGN CALCULATIONS FOR EXISTING MASTER ROD

- Flange Thickness (t) = 5mm
- I – Section Width (B) = 4t = 20mm
- I – Section Height (H) = 5t = 25mm
- I – Section Area (A) = 11t² = 275 mm²
- Height of the Big End(H₂)= (1.1 - 1.25) H =28mm
- Height of the Small End (H₁) = (0.9 – 0.75) H = 23mm

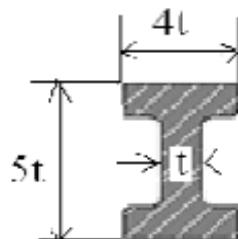

Fig 3.1: I – Section Standard Dimension

M. O. I of I- Section about x – axis is given by

$$I_{x-x} = 1/12(BD^3 - bd^3)$$

$$= 1/12\{4t (5t)^3 - 3t (3t)^3\}$$

$$= 34.91t^{2*2}$$

$$I_{x-x} = 21818.75 \text{ mm}^4$$

M. O. I of I- Section about y – axis is given by

$$I_{y-y} = 1/12(bd^3 - BD^3)$$

$$= 1/12\{2t (4t)^3 + 3t (t)^3\}$$

$$= 10.91t^{2*2}$$

$$I_{y-y} = 6818.75 \text{ mm}^4$$

Ratio of I_{x-x} and I_{y-y}

length of master rod (n¹) = L/ r

$$= 2$$

Angular speed (w) is given by

$$\omega = 2\pi N / 60$$

$$= 2\pi 1500/60$$

$$\omega = 157.1 \text{ rad/sec}$$

Inertia force of reciprocating parts

$$F = \frac{1000WrV^2}{gr} \text{Cos}\theta \pm \frac{\text{Cos}2\theta}{n^1}$$

Weight of Reciprocating Parts

$$W = mg = 2(9.81) = 19.62N$$

Crank Angle for Dead Centre (Θ) = 0

Accelartion due to Gravity (g)= 9.81 m /Sec²



$$= I_{x-x} / I_{y-y}$$

$$= 3.19$$

Radius of gyration (Kxx)

$$K = \sqrt{I_{x-x} / A}$$

$$= 1.78t$$

$$= 8.9.$$

W.K.T

Stroke length (L) = 32 mm.
 crank radius (r) = L/2
 = 16 mm.

$$v = rw = 9.81m/s$$

$$F_i = 15036.8N$$

Total force of Master rod

$$F_C = F_P - F_i$$

F_p = Force of piston = 21800N

$$F_c = 21800 - 15036.8$$

$$F_c = 6764N$$

Sl. no	Parameters	mm
1	Thickness of the Master Rod	5
2	Width of the Section (B=4t)	20
3	Height of Section (H=5t)	25
4	Height of the Big End	28
5	Height of the Small End	23
6	Inner Diameter of Small End	24
7	Outer Diameter of Small End	35
8	Inner Diameter of Big End	52
9	Outer Diameter of Big End	69

Table 3.1: Parameters of Master Rod

Sl.no	Mechanical Properties	Unit	SSA36	Al T6 6061
1	Density	kg/m ³	7850	2770
2	Co-efficient of thermal expansion	/c	1.2e-5	2.3e-5
3	Young's modulus (E)	Mpa	2e5	2e5
4	Poisson's ratio	-	0.3	0.33
5	Bulk modulus	Pascal	1.6667e11	6.9e11
6	Shear modulus	Pascal	7.6923e11	2.66992e10
7	Tensile yield strength	Mpa	250	280
8	Compressive yield strength	Mpa	250	280
9	Tensile ultimate strength	Mpa	460	310
10	No. of cycle to failure	-	1x10 ⁶	1x10 ⁸

Table 3.2: Mechanical Properties of SS A36 and Al T6 6061,[9]

Sl.no	Chemical Elements	Symbol	Atomic no	SS A36 in %	Al T6 6061 in %
1	Carbon	C	6	0.25-0.290	-
2	Copper	Cu	29	0.20	0.15-0.40
3	Iron	Fe	26	98.0	0.7
4	Manganese	Mn	33	1.03	0.8-1.2
5	Phosphorous	P	15	0.040	-
6	Silicon	Si	14	0.280	0.4-0.8
7	Sulphur	S	16	0.050	-
8	Zinc	Zn	30	-	0.25
9	Titanium	Ti	22	-	0.15
10	Chromium	Cr	24	-	0.04-0.35
11	Other	-		-	0.05

Table3.3: Chemical Properties of SS A36 and Al T6 6061,[9]

Standard earth gravity	9806.6 mm/s
Fixed support	-
Rotational velocity	Up to 6000rpm
Force 2	-6764 N
Force 1	6764 N

Table 3.4: Boundary Conditions of Master Rod

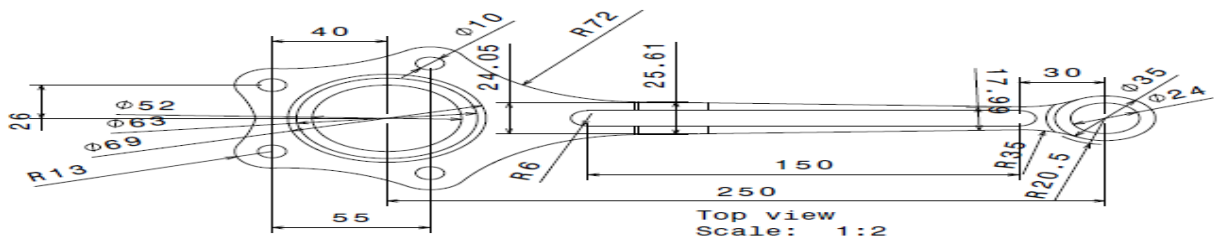
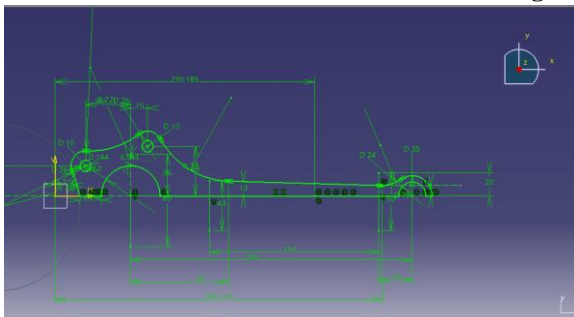
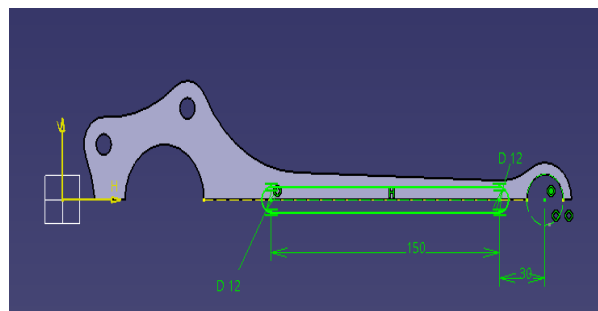

Fig 3.2: 2D Drawing of Mater Rod

IV. 3D Modeling of Master Rod Using CATIA V5 R20



(a)



(b)

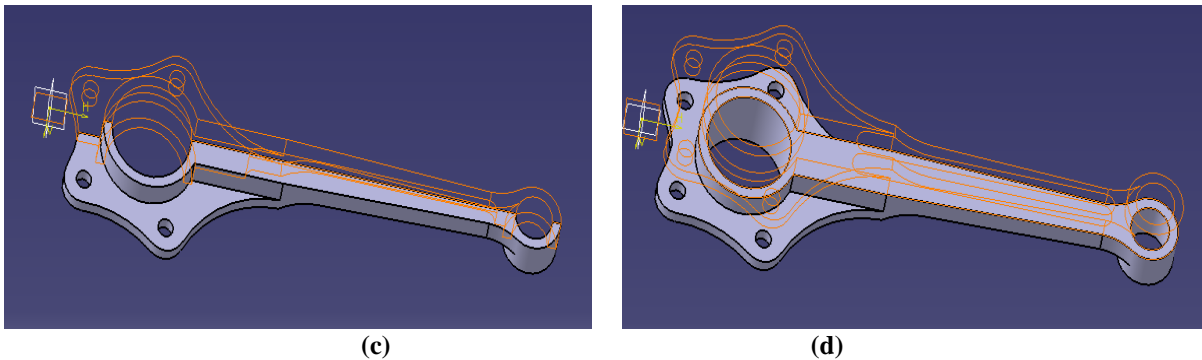

Fig 4.1: Different Stages of Master Rod using CATIA V5 R20 (a) Dimensions according to table (b) Extruded Half (c) Mirroring of Half Master Rod (d) Mirroring of Full Master Rod

V. RESULT ANALYSIS OF THE MASTER ROD

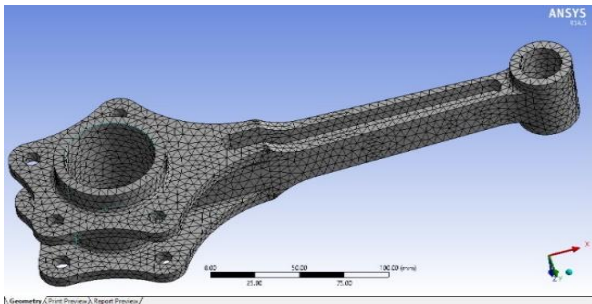

Fig 5.1: Meshing Structural Steel A36

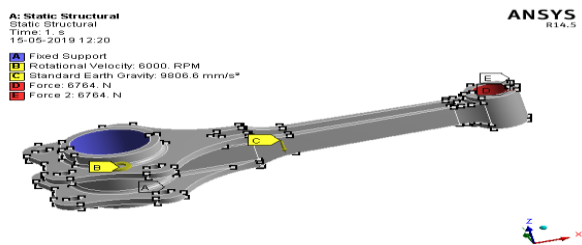

Fig 5.2: Boundary Conditions Aluminium T6 6061

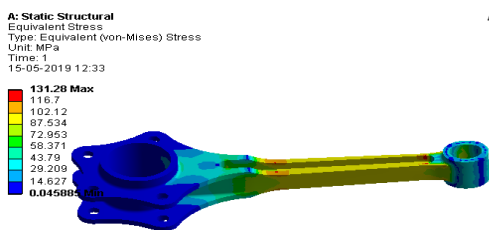

Fig 5.3: Equivalent Stress of SS A36

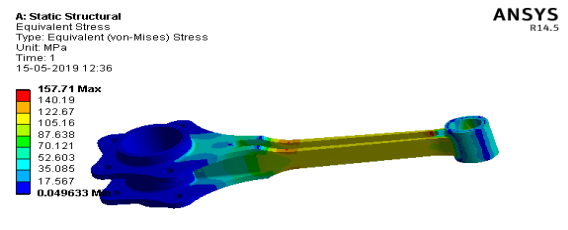
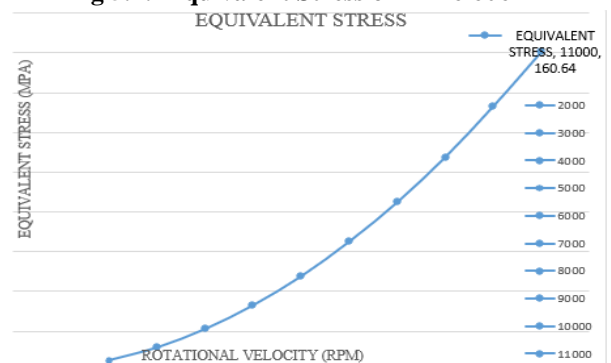
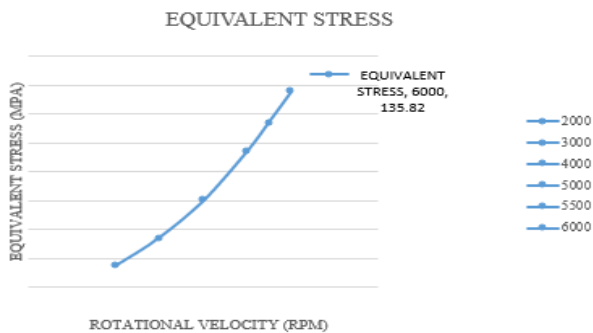

Fig 5.4: Equivalent Stress of Al T6 6061



Graph 5.1: Equivalent Stress V/S Rotational Velocity of SS A36 and Al T6 6061

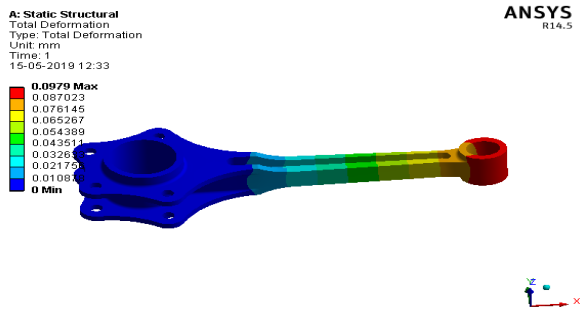

Fig 5.5: Total Deformation of SS A36

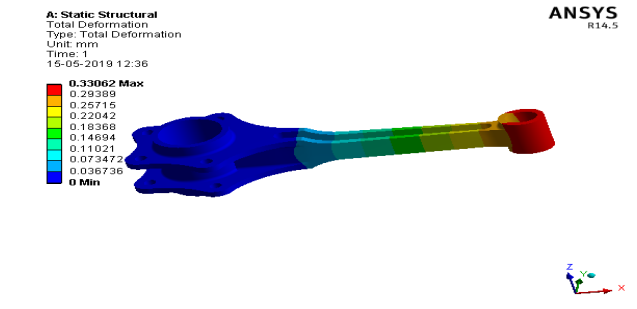
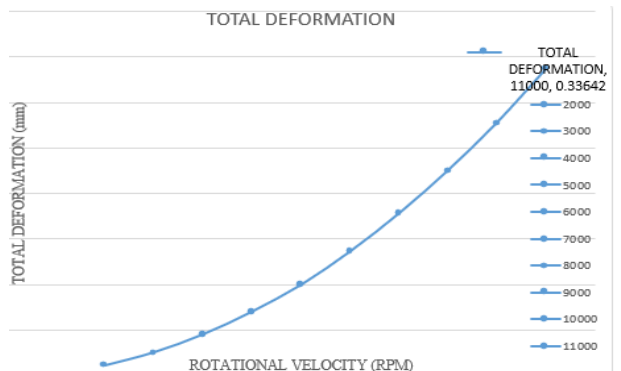
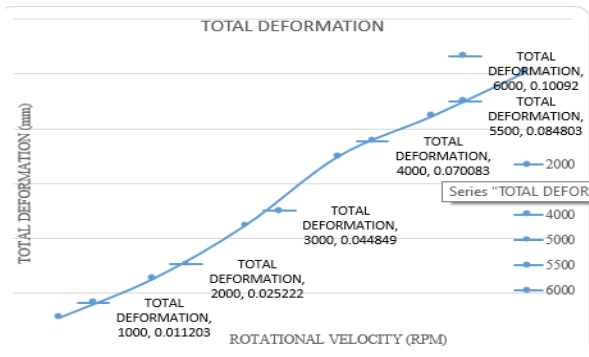

Fig 5.6: Total Deformation of Al T6 6061



Graph 5.2: Total Deformation V/S Rotational Velocity of SS A36 and Al T6 6061

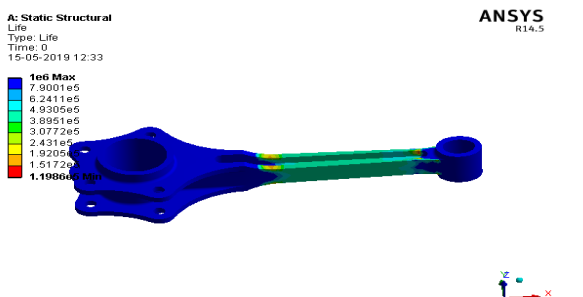

Fig 5.7: Fatigue Life of SS A36

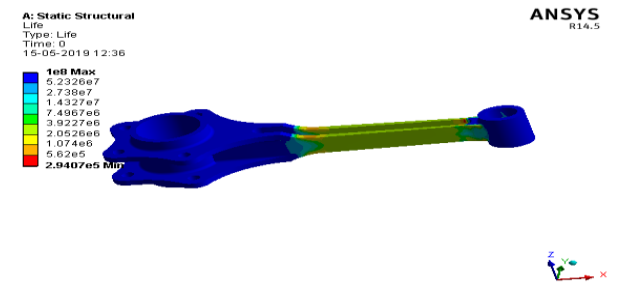
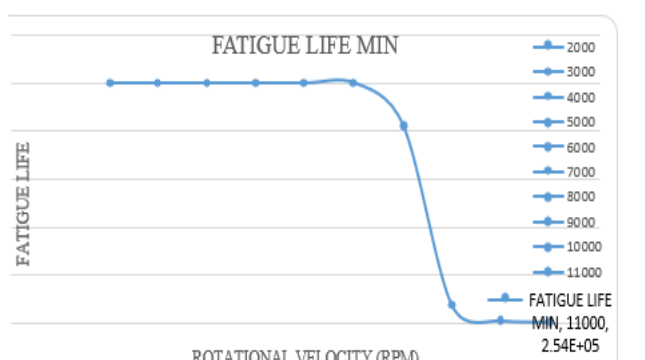
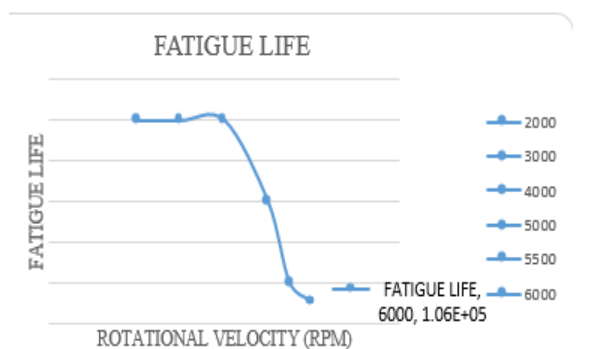

Fig 5.8: Fatigue Life of Al T6 6061



Graph 5.3: Fatigue Life V/S Rotational Velocity of SSA36 and Al T6 6061

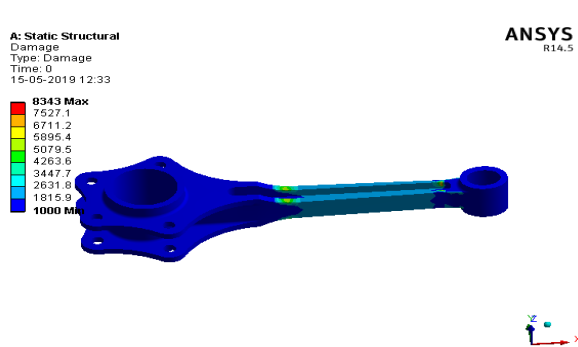

Fig5.9: Fatigue Damage of SSA36

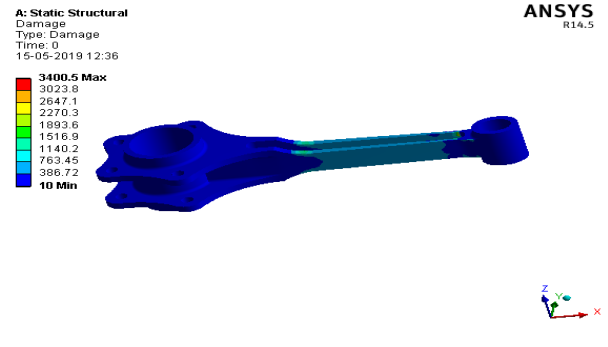
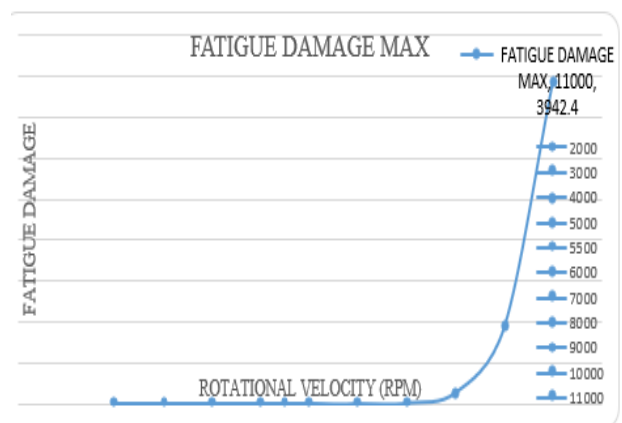
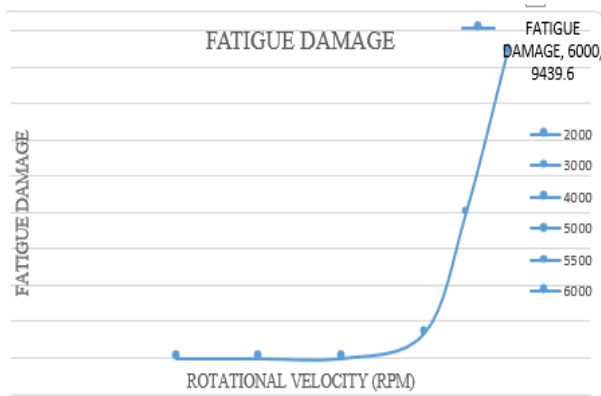

Fig 5.10: Fatigue Damage of Al T6 6061



Graph 5.4: Fatigue Damage V/S Rotational Velocity of SS A36 and Al T6 6061

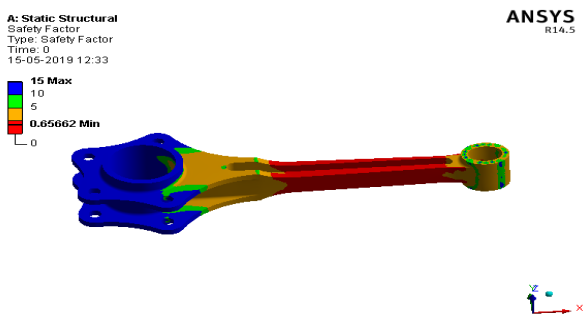

Fig 5.11: Safety Factor of SS A36

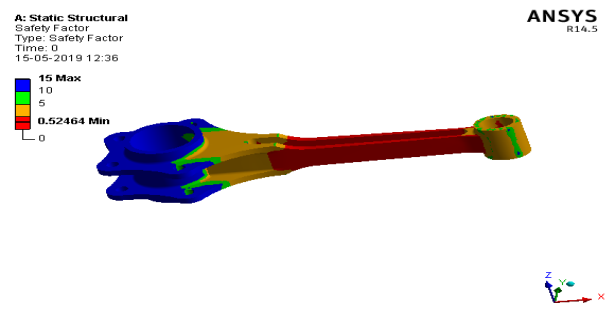
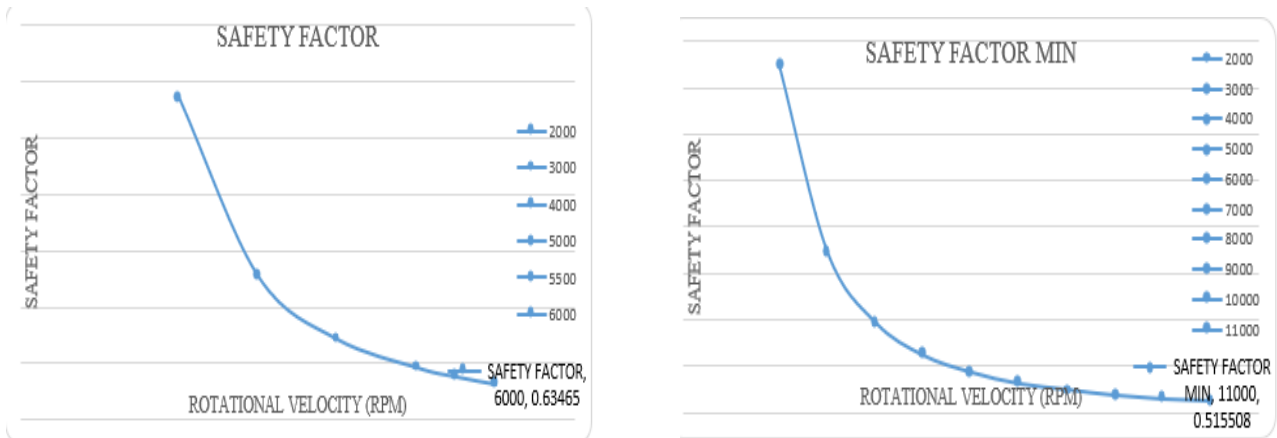
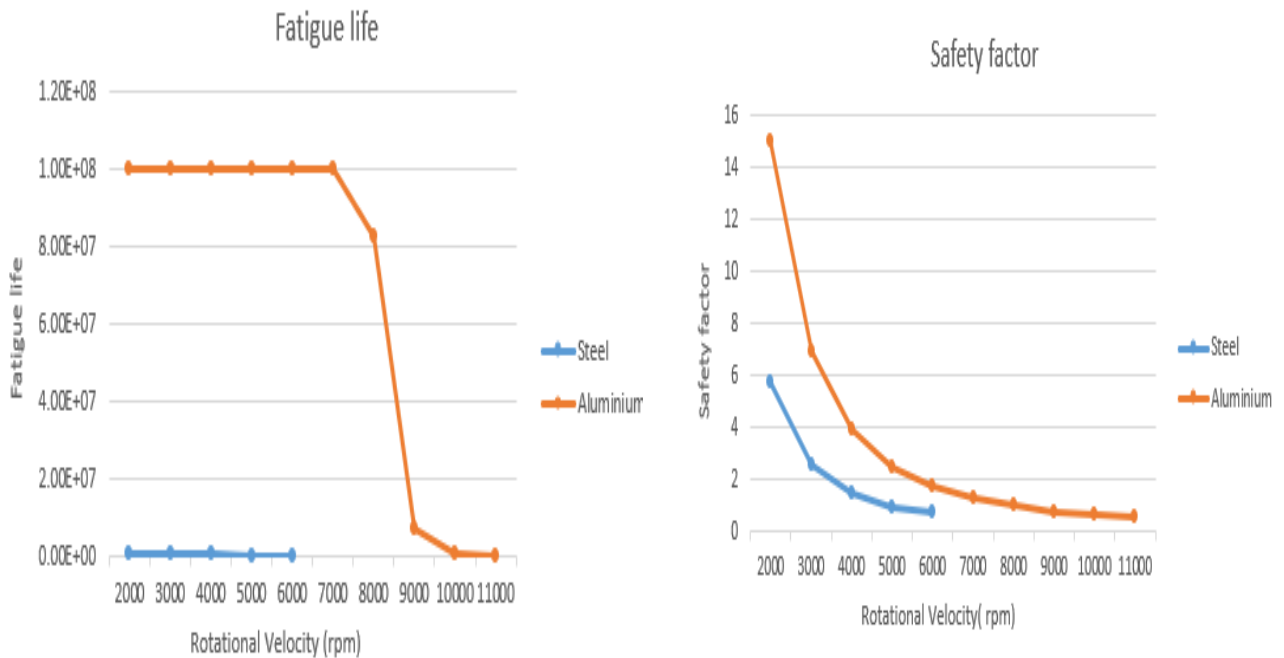

Fig 5.12: Safety Factor of Al T6 6061



Graph 5.5: Safety Factor V/ S Rotational Velocity of SS A36 and Al T6 6061



Graph 6 : Comparison of Fatigue Life and Factor of Safety for SS A36 and Al T6 6061

Sl.no	Rotational Velocity (RPM)	Types	Structural Steel A36		Aluminium T6 6061	
			Max (Mpa)	Min (Mpa)	Max (Mpa)	Min (Mpa)
1	3000	Equivalent Stress	33.946	0.0123	11.944	0.0017321
2		Total Deformation	0.0252	0	0.025012	0
3		Fatigue Life	1e6	1e6	1e8	1e8
4		Fatigue Damage	15	2.5394	15	6.9275
5		Safety Factor	1000	1000	10	10

Table 5.1: Analytical Results of ANSYS 14.5 for Rotational Velocity 3000 RPM



Sl.no	Rotational Velocity (RPM)	Types	Structural Steel A36		Aluminium T6 6061	
			Max (Mpa)	Min (Mpa)	Max (Mpa)	Min (Mpa)
1	6000	Equivalent Stress	131.28	0.048742	47.789	0.0105165
2		Total Deformation	0.10092	0	0.10008	0
3		Fatigue Life	1e6	1.0594e5	1e8	1e8
4		Fatigue Damage	15	0.63465	15	1.7314
5		Safety Factor	9439.6	1000	10	10

Table 5.2: Analytical Results of ANSYS 14.5 for Rotational Velocity 6000 RPM

VI. RESULTS AND CONCLUSIONS

In the present work Solid Modelling of Master Rod is modelled by using CATIA V5R20 and Simulation was done by using ANSYS 14.5. Analysis was performed for few parameters like Stress distribution, Total deformation, Fatigue damage, Fatigue Life and FOS and also Comparison made between SS A36 and Al T6 6061.

SS A36 master rod as maximum equivalent stress distribution of 131.28 Mpa. The yield strength of SSA36 is 250Mpa and maximum stress occurred at crank end, which is less than the yield strength hence rotational velocity of 6000rpm to master rod is applied by considering the FOS within the range of 1.5 – 2 after increasing in rotational velocity above 6000rpm for SSA36, master rod may leads to fail, hence maximum rotational velocity should be within 6000rpm for SS A36.

Al T6 6061 master rod as maximum equivalent stress distribution of 47.789 Mpa. The yield strength of SSA36 is 280Mpa and maximum stress occurred at crank end, which is less than the yield strength hence rotational velocity of 6000rpm to master rod is applied by considering the FOS within the range of 2.4 – 2.8 after increasing in rotational velocity above 6000rpm for Al T6 6061, master rod will not fail, hence maximum rotational velocity should be within 11000rpm for Al T6 6061.

SS A36 total deformation of master rod as maximum 0.10092mm, because at the fixed ends does not allow to deform similarly Al T6 6061 as 0.10008mm.

SS A36 Fatigue life of master rod as maximum 1×10^6 cycles and minimum 1.05×10^6 cycles, similarly Al T6 6061 as maximum and minimum of 1×10^6 cycles.

FOS is used to check the strength and weaker sections of the geometry; it is observed that weaker section with FOS 0.65 and 0.52 for SS A36 and Al T6 6061 respectively and here to increase thickness to overcome the failure in weaker section.

- SS A36 has more Equivalent stress compared to Al T6 6061.
- SS A36 has almost equal Total Deformation compared to Al T6 6061.
- SS A36 has less Fatigue life compared to Al T6 6061.
- SS A36 has equal Fatigue Damage compared to Al T6 6061.
- SS A36 has less FOS compared to Al T6 6061.

REFERENCES

- [1] Dynamic Load Analysis and Optimization of a Connecting Rod- R. Ravi, K.V.P.P. Chandu, B. Subramanyam.
- [2] Design of connecting rod of internal combustion engine a topology optimization approach-m.s. shaari1, m.m. rahman1,2, m.m. noor1, k. kadirgama1 and a.k. amirruddin1.
- [3] Modeling and Analysis of Two-Wheeler Connecting Rod -K. Sudarshan Kumar1, Dr. K. Tirupati Reddy2, Syed Altaf Hussain3.
- [4] Kuldeep B1, Arun L.R2, Mohammed Faheem P.G. Scholar, Department of Mechanical Engineering, The Oxford college of Engineering, Karnataka, India, Associate Professor, Department of Mechanical Engineering, The Oxford college of Engineering, Karnataka, India

- [5] Fatigue analysis of connecting rod of universal tractor through finite element method (ANSYS)-A. Mirehei, M. HedayatiZadeh, A. Jafari, M. Omid Department of Agricultural Machinery Engineering, Faculty of Bio system Engineering, University of Tehran, Iran.
- [6] Static *Stress* Analysis of Connecting Rod Using Finite Element Approach_ AbhinavGautam1, K Priya Ajit_1 M. TECH Student, Department of Maintenance Engineering and Tribology, ISM, Dhanbad 2 Assistant professor, Department of Mining Machinery Engineering, ISM, Dhanbad.
- [7] Garima Chaudhary Department of Aerospace Engineering University of Petroleum and Energy Studies, Satyam Saini Department of Aerospace Engineering University of Petroleum and Energy Studies, Sandeep Sharma Technical Head Aero Sphere.
- [8] Srikanth kumar and B. Jitendra (IETRJ) International Engineering and Technology Research Journal, Vol. 2(1), 2015, 131-135.
- [9] Design Data Hand Book (DDH), K. Mahadevan and Dr. K. Balaveera Reddy-B. S Publishers and Distributors.
- [10] Machine Design Exercises, S.N Trika, Khanna Publishers.
- [11] High Speed Combustion Engines, P.M. Heldt, Oxford and IBH Publishing Co.
- [12] Automotive Design, R.B. Gupta.
- [13] Automotive engine fundamentals F.E. Peacock. T.E. Gaston Reston automotive Series Pub.
- [14] Moulded Engine Castings, "General - MotorsApril1956, Eng. J.3, March 12. Review of G.M. methods and techniques.
- [15] 1951, 42 and Sons, Inc., New York, 1966. Recent, Authoritative. Includes Theory, materials design, Manufacturing.
- [16] (1940). Continental-opposed cylinder air-cooled line. Aviation Industries 93, Dec. 15, 1945. Post war series of horizontal- Opposed air-cooled engines. Cambridge, Mass., 1950. Corp., Detroit, 1961. Trans.SAE 47, 301
- [17] (1940). Loaming 4-cylinders horizontal opposed engine with internal spur gear and second order and fourth-order Pendulum vibration absorbers.
- [18] Post-war series of horizontal opposed air-cooled Engines.
- [19] Aviation, July 1933, 201. Rational Approach to choice of stroke-bore ratio for radial engines. An example of good analysis of a major design problem.
- [20] Leela Krishna Vegi, Venugopal-Design and Analysis of Connecting Rod Using Forged steel
- [21] Website (Google, Wikipedia,)
- [22] Finite Element Analysis of Connecting Rod Using Ansys Inikhil U. Thakare, 2nitin D. Bhusale, 3rahul Shinde, 4mahesh M. Patil 1,3,4b.E., Babasaheb Naik College of Engineering, Pusad, Maharashtra, India, 2research Scholar