

# Light Dependent Resistor Product Separator

Atharva Dingore<sup>1</sup>, Darshan Salunkhe<sup>2</sup>, Hritik Kalantri<sup>3</sup>

B.E. Student, Department of Mechanical Engineering, Guru Gobind Singh College of Engineering, Nashik, Maharashtra, India<sup>1</sup>

B.E. Student, Department of Mechanical Engineering, Dr. D.Y. Patil Institute of Engineering Management and Research, Akurdi, Pune, India<sup>2</sup>

B.E. Student, Department of Mechanical Engineering, Pune Vidhyarthi Griha's College of Engineering and Technology, Pune, India<sup>3</sup>

**ABSTRACT:** Due to the increasing demand for compact electronic components, the prices of such components are increasing day-by-day. We should be able to produce circuits with a minimum number of electronic components and find replacements for the high costing parts. In Production lines where RYB colour sensors are used for colour sensing and separation purpose, LDR (Light Dependent Resistor) can be the exact replacement in certain cases. For the same, a circuit provided with a mechanism for separation purpose is designed. Basically, this machine separates products according to different colours by using a Microcontroller, Relays and Motors along with the LDR. The aim of this machine is to replace RYB colour sensors by LDR (Light-dependent resistor) which are 30-40 times cheaper and cost-efficient than a colour sensor. For this, some additional modifications are required in the circuit.

**KEYWORDS:** Arduino Micro-controller, Colour Separation, Light Dependent Resistor, Scotch Yoke Mechanism.

## I. INTRODUCTION

Mechatronics is an interdisciplinary branch of engineering which involves Mechanical, Electronics, Control, and few other sectors. Mechatronics grants precise control over the advanced machinery in manufacturing industries. Mechatronics vastly depends on the sensors and logic circuits. Advanced Mechatronics elements have a very high significance in the industrial sector.

A photoresistor is one of the major contributors in creating light-sensitive circuits. The light-dependent resistor (LDR) is a type of photoresistor whose resistance decreases when light falls on it. It is made of light-sensitive semiconducting material. It is commonly used in light-sensitive circuits, automatic streetlamp control and line-follower robots.

In a Case Study, the LDR is used as a colour sensor. This specific LDR based colour sensor is very sensitive and requires special environmental conditions such as an isolated dark room but it is much cost-effective compared to RYB sensors. In a Product Separator, LDR is used to respond to the change in intensity of light inside a closed space. When an object with a distinct colour comes inside the detection unit, certain variation in the light intensity is sensed by LDR and it is further calculated in the Arduino Microcontroller. The microcontroller further controls the mechanism and the product separation takes place.

## II. LITERATURE REVIEW

1. Application of LDR- A case study in a small-scale industry published by Daniel Acosta-Avalos on Research Gate in 2006 focused on how LDR can be used in spectroscopy setups as a sensor by using pulsed light. A photoacoustic spectroscopy setup was used, substituting the photoacoustic chamber by the light sensor proposed. The absorption spectra of two different liquids were analysed. The results obtained allow the recommendation of the LDR as the first choice in the construction of cheap homemade pulsed light spectroscopy systems. Thus, LDR can be used as a sensor was first experimented and proved in this article.

2. Another case study was done on the similar topic which was published by Mustafa Saad, AbdalhalimFarij, Ahamed Salah and AbdalroofAbdaljalil on Research Gate in 2013 which explained how LDR along with some photoelectric sensors was used in Automatic Street Light control system. The application of these sensors helped to save electricity and reduce efforts of humans to manually control the Street Lights during the night and daytime.

3. In a research paper published by Jawaaz Ahmad and Romana Yousuf on International Journal of Innovative Research in Computer and Communication Engineering in 2016 which empathized on How using LDR low-cost light intensity measurement circuit was designed i.e. Lux Meter. This design included simple comparator and LDR, which

would provide us with data about the intensity of light at a very low cost. The conclusion of this was the design using LDR was a better replacement for current high-cost light intensity meters.

### III. METHODOLOGY

Product Separation by using Photoresistors, microcontroller and a mechanism for separation-

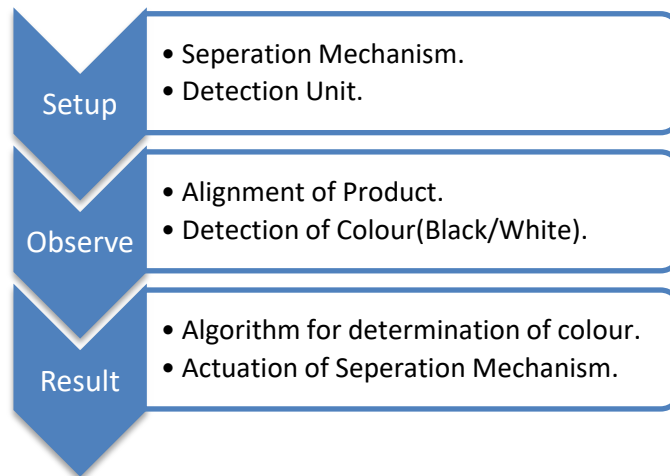

#### A. Setup: -

This setup is divided into two parts, the detection unit and the separation mechanism as shown in the fig.1.

- Detection Unit- The Detection unit consists of an LDR, an Arduino microcontroller, two relays (240V AC to 5V DC), a 1000Ω resistor, breadboard, jumper cables, regular wires, and a LED. Inside the Detection Unit, a black light-absorbing sheet is provided to avoid all the external light from entering the detection unit. This creates an isolated dark environment for better results. The Fig.2 shows the detection unit.

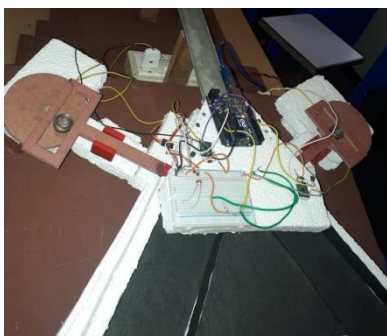

Fig.1 Product Separator

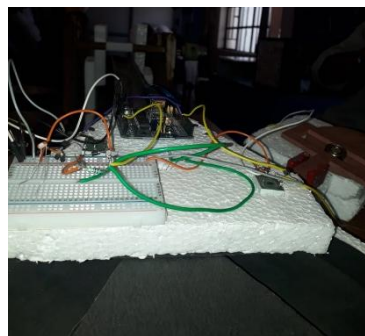

Fig.2 Detection Unit

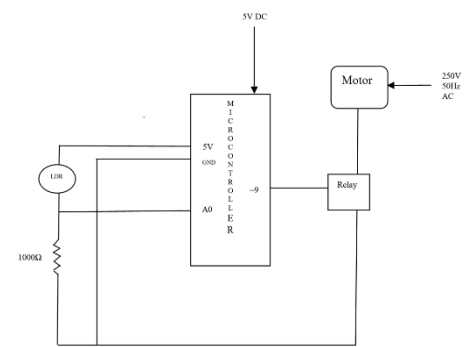

Fig.3 Block diagram for one motor

- The Mechanism- The Scotch Yoke Mechanism is an inversion of Double Slider Crank Mechanism. Two scotch yoke mechanisms guide the opening and closing of gateways through the Detection Unit. Two high torque AC motors are connected to each crank for providing rotary motion to the crank. The mechanism is shown in Fig.3 and 4.

#### B. Observe: -

- Alignment of product- Marbles of two different colours (black and white) were used in this process. These marbles are first kept on the conveyor belt. From there they further proceed to the Detection Unit. Inside the detection unit, guideways are placed for proper alignment of the marble, as shown in fig.5.

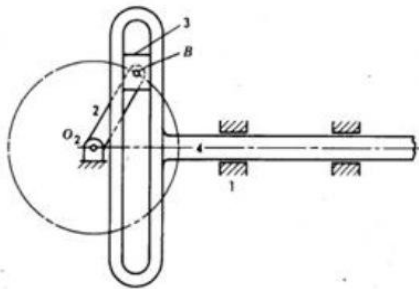

Fig.4 Scotch Yoke Mechanism

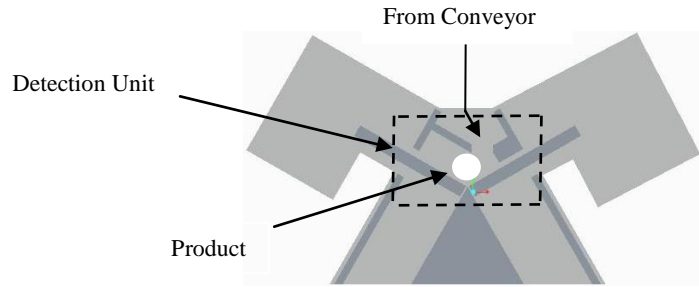

Fig.5 Alignment of Product

• Detection of colour- As shown in Fig.6, the LED inside the detection unit is switched ON by the external electric supply. This light is sensed by the LDR. It is placed on the top side of the detection unit. LDR provides a constant value of light intensity to the microcontroller. When a marble enters the detection unit, there is a change in the intensity of light as different colours reflect a variable amount of light on the LDR, thus producing a change in resistance.

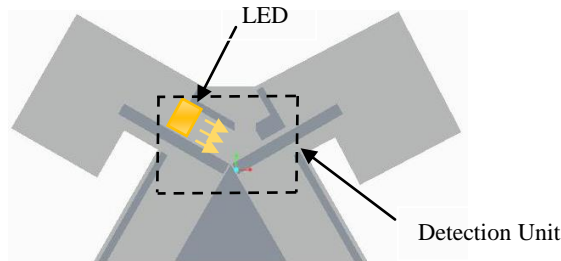

Fig.6 Detection of colour

#### IV. EXPERIMENTAL RESULTS

Fig.7 shows the results of the case study. It is observed that the microcontroller records the change in light intensity by calculating the change in the resistance offered by the LDR. At maximum light intensity of the LED bulb, two ranges of resistance were recorded. For black marble- 25.0Ω to 19.1Ω and white marble-17.5Ω to 12.4Ω

More light is reflected on the LDR when a white marble enters the detection unit. On the other hand, when a black marble enters the detection unit, comparatively less light is reflected on the LDR. These results were used to program the microcontroller and actuate the motors according to the colour determined

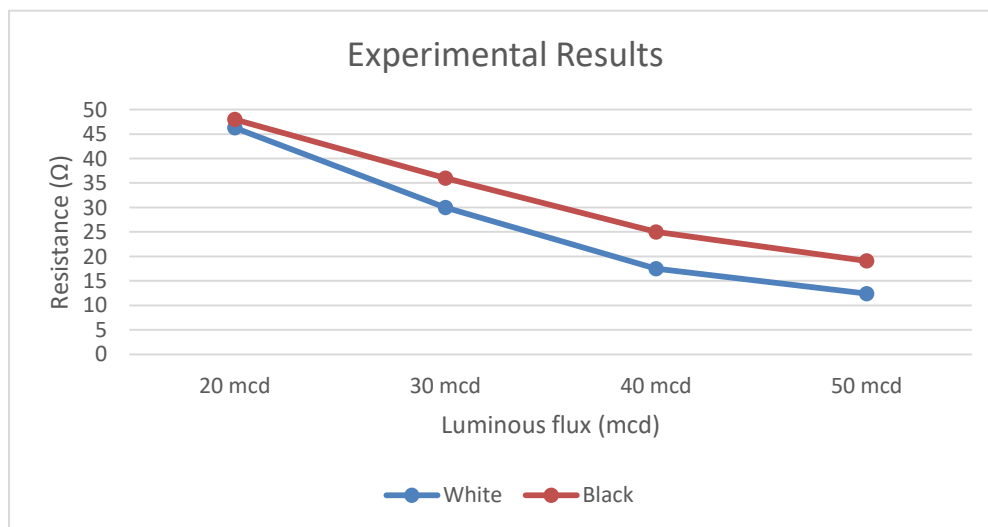

Fig.7 Lux-Resistance Graph

A. Algorithm for the detection of colour: -

1. Start
2. Set the direction of Arduino A0 analog pins as an input using pinMode() function to read Analog voltage proportional to LDR.
3. Configure PD5 and PD6 pins as output pins to actuate motors.
4. Set voltage differences for each colour as Integers, int A and int B.
5. Setup the serial communication between PC and Arduino.
6. Read Analog voltage value through A0 pin using analogRead() function.
7. Print Digital output value of in-built ADC on Serial Monitor Window of Arduino IDE.
8. If Arduino reads int A then call analogWrite(5,OUTPUT) or if Arduino reads int B then call analogWrite(6,OUTPUT).
9. End.

B. Actuation of separation mechanism: -

- For every marble having a resistance value in between  $25.0 \Omega$  to  $19.1 \Omega$ , motor A start which rotates the crank. The yoke converts the rotary motion of crank into the linear motion of the gate A, thus opening gate A as shown in fig.8
- For every marble having a resistance value between  $17.5 \Omega$  to  $12.4 \Omega$ , motor B start which rotates the crank. The yoke converts the rotary motion of crank into the linear motion of the gate B, thus opening gate B as shown in fig.9
- After Separation, the marbles are collected in their respective bins.

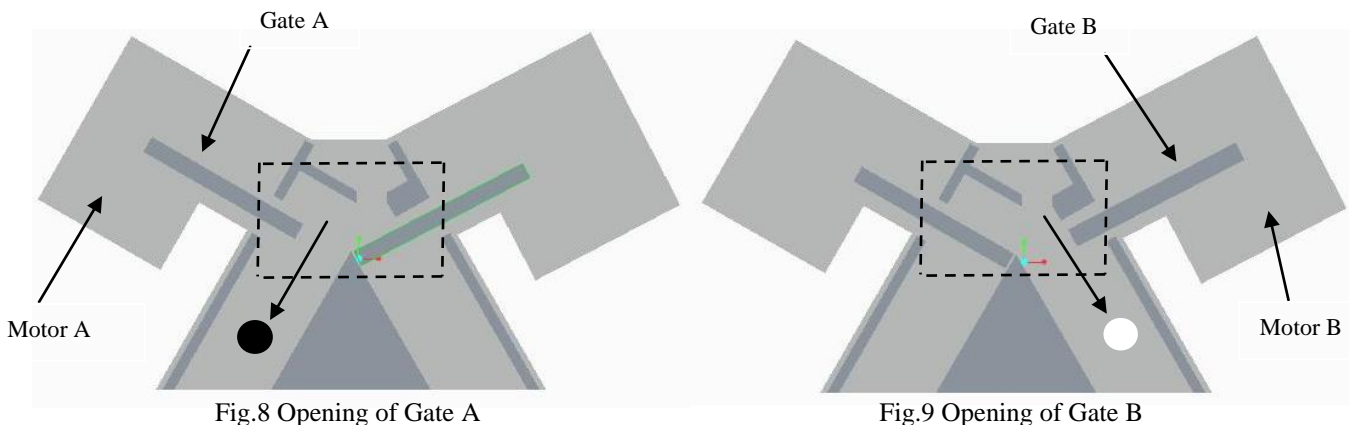

## V. FUTURE SCOPES

- In the above case study, the efficiency of the machine can be increased by incorporating a servo motor.
- This type of machine can also be used in automobile or any other manufacturing industries where Inventory Tags of different colours are used for storage of raw materials. Products having different colour tags can be separated by the above machine.

## VI. CONCLUSION

According to the case study above, by using LDR and a microcontroller, a product separation mechanism can be created. By properly isolated environment sensitivity of LDR can be increased. We can increase the bandwidth of the product separator and different coloured products can be separated. Even shades of a similar colour can also be separated by making some modifications in the setup and the circuit.

Photoresistors or Light Dependent Resistors can replace colour sensors in some applications. They are very cost-efficient and perfect for small-scale industries.

## REFERENCES

- [1] <https://www.ncbi.nlm.nih.gov/pmc/articles/PMC3872342/>
- [2] [https://www.researchgate.net/publication/321318899\\_Automatic\\_Street\\_Light\\_Control\\_System\\_Using\\_Microcontroller](https://www.researchgate.net/publication/321318899_Automatic_Street_Light_Control_System_Using_Microcontroller)
- [3] [http://www.ijirce.com/upload/2016/august/23\\_LIGHT.pdf](http://www.ijirce.com/upload/2016/august/23_LIGHT.pdf)
- [4] <https://www.termpaperwarehouse.com/essay-on/Ldr-Research-Paper/104102>.