



e-ISSN: 2319-8753 | p-ISSN: 2347-6710

IJRSET

International Journal of Innovative Research in
SCIENCE | ENGINEERING | TECHNOLOGY

INTERNATIONAL JOURNAL OF INNOVATIVE RESEARCH

IN SCIENCE | ENGINEERING | TECHNOLOGY

Volume 12, Issue 7, July 2023

ISSN INTERNATIONAL
STANDARD
SERIAL
NUMBER
INDIA

Impact Factor: 8.423

9940 572 462

6381 907 438

ijrset@gmail.com

www.ijrset.com

Improvement of Power Quality and Reduction of Harmonic in Distribution System Using DPFC

Prathamesh P. Raut¹, Souras Ghotekar², Mamta Runge³

Student, Department of EE, Vidarbha Institute of Technology, Nagpur, India

Assistant Professor, Department of EE, Vidarbha Institute of Technology, Nagpur, India

Assistant Professor, Department of EE, Vidarbha Institute of Technology, Nagpur, India

ABSTRACT - A new component within the flexible ac-transmission system (FACTS) family, called distributed power-flow controller (DPFC). The DPFC is derived from the unified power-flow controller (UPFC). The DPFC can be considered as a UPFC with an eliminated common dc link. The active power exchange between the shunt and series converters, which is through the common dc link in the UPFC, is now through the transmission lines at the third-harmonic frequency. The DPFC employs the distributed FACTS (D-FACTS) concept, which is to use multiple small-size single-phase converters instead of the one large-size three-phase series converter in the UPFC. The large number of series converters provides redundancy, thereby increasing the system reliability. As the D-FACTS converters are single-phase and floating with respect to the ground, there is no high-voltage isolation required between the phases. Accordingly, the cost of the DPFC system is lower than the UPFC. The DPFC has the same control capability as the UPFC, which comprises the adjustment of the line impedance, the transmission angle, and the bus voltage. The principle and analysis of the DPFC are presented in this paper and the corresponding experimental results that are carried out on a scaled prototype are also shown.

KEYWORDS – DPFC, Sag, Swell, Harmonics, Convertors

I. INTRODUCTION

In modern power systems, there is a great demand to control the power flow actively. Power flow controlling devices (PFCDs) are required for such purpose, because the power flow over the lines is the nature result of the impedance of each line. Due to the control capabilities of different types of PFCDs, the trend is that mechanical PFCDs are gradually being replaced by Power Electronics (PE) PFCDs. Among all PE PFCDs, the Unified Power Flow Controller (UPFC) is the most versatile device. However, the UPFC is not widely applied in utility grids, because the cost of such device is much higher than the rest of PFCDs and the reliability is relatively low due to its complexity. The objective of this thesis is to develop a new PFCD that offers the same control capability as the UPFC, at a reduced cost and with an increased reliability. The new device, so-called Distributed Power Flow Controller (DPFC), is invented and presented in this thesis. The DPFC is a further development of the UPFC.

The DPFC eliminates the common DC link within the UPFC, to enable the independent operation of the shunt and the series converter. The D-FACTS concept is employed in the design of the series converter. Multiple low-rating single-phase converters replace the high-rating three-phase series converter, which greatly reduces the cost and increases the reliability. The active power that used to exchange through the common DC link in the UPFC, is now transferred through the transmission line at the 3rd harmonic frequency. The DPFC has been modeled in a rotating dq-frame. Based on this model, the basic control of the DPFC is developed. The basic control stabilizes the level of the capacitor DC voltage of each converter and ensures that the converters inject the voltages into the network according to the command from the central control. The shunt converter injects a constant current at the 3rd harmonic frequency, while its DC voltage is stabilized by the fundamental frequency component. For the series converter, the reference of the output voltage at the fundamental frequency is obtained from the central controller and the DC voltage level is maintained by the 3rd harmonic component.

II. UNIFIED POWER FLOW CONTROLLER (UPFC)

A Unified Power Flow Controller (or UPFC) is an electrical device for providing fast-acting reactive power compensation on high-voltage electricity transmission networks. It uses a pair of three-phase controllable bridges to produce current that is injected into a transmission line using a series transformer. The controller can control active and reactive power flows in a transmission line. The UPFC uses solid state devices, which provide functional flexibility, generally not attainable by conventional thyristor controlled systems. The UPFC is a combination of a static synchronous compensator (STATCOM) and a static synchronous series compensator (SSSC) coupled via a common DC voltage link.

The components of UPFC handle the voltages and currents with high rating; therefore, the total cost of the system is high. Due to common dc-link interconnection, a failure that happens at one converter will influence the whole system. To achieve the required reliability for power system, bypass circuit and redundant backups are needed, which on other hand increase the cost. Accordingly, the UPFC has not been commercially used, even though, it has the most advanced control capabilities.

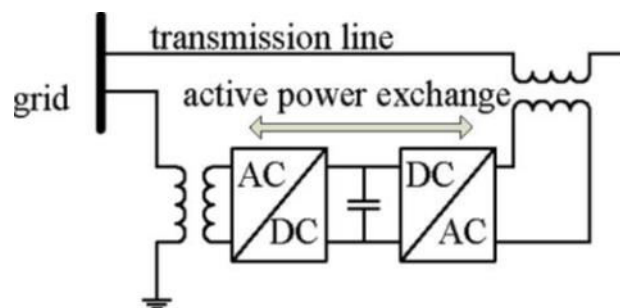

Fig. 1 Simplified representation of a UPFC

III. DISTRIBUTED POWER FLOW CONTROLLER (DPFC)

Distributed Power Flow Controller is an alternative device to established UPFC which has same control capability as that of UPFC. This can be implemented with low cost and high reliability. Converters used in this project will convert DPFC single phase which works for both active and reactive of both negative and zero unbalanced currents.

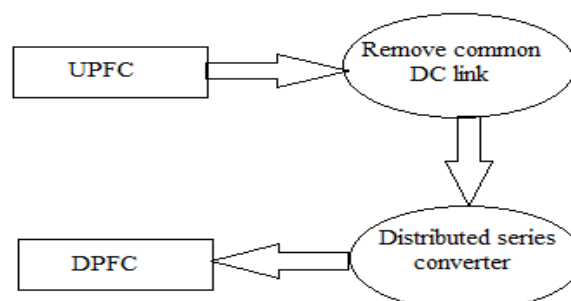

Fig. 2 Flowchart of UPFC converted to DPFC

Two approaches are applied to the UPFC to increase the reliability and to reduce the cost; they are as follows. First, eliminating the common dc link of the UPFC and second distributing the series converter, as shown in Fig. 2. By combining these two approaches, the new FACTS device—DPFC is achieved. The DPFC consists of one shunt and several series-connected converters. The shunt converter is similar as a STATCOM, while the series converter employs the D-FACTS concept, which is to use multiple single-phase converters instead of one large rated converter. Each

converter within the DPFC is independent and has its own dc capacitor to provide the required dc voltage. The configuration of the DPFC is shown in Fig. 2. As shown, besides the key components, namely the shunt and series converters, the DPFC also requires a high-pass filter that is shunt connected at the other side of the transmission line, and two Y-Δ transformers at each side of the line. The reason for these extra components will be explained later. The unique control capability of the UPFC is given by the back-to-back connection between the shunt and series converters, which allows the active power to exchange freely. To ensure that the DPFC have the same control capability as the UPFC, a method that allows the exchange of active power between converters with eliminated dc link is the prerequisite.

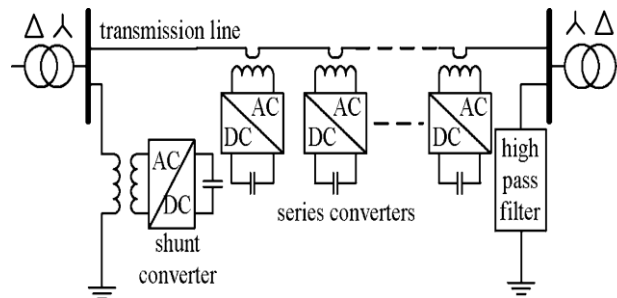

Fig. 3 DPFC Configuration

A. Eliminate DC Link

Within the DPFC, there is a common connection between the ac terminals of the shunt and the series converters, which is the transmission line. Therefore, it is possible to exchange the active power through the ac terminals of the converters. The method is based on the power theory of non sinusoidal components. According to the Fourier analysis, a non sinusoidal voltage and current can be expressed by the sum of sinusoidal functions in different frequencies with different amplitudes. The active power resulting from this non sinusoidal voltage and current is defined as the mean value of the product of voltage and current. Since the integrals of all the cross product of terms with different frequencies are zero, the active power can be expressed by

$$P = \sum V_i I_i \cos \phi_i \quad (1)$$

where V_i and I_i are the voltage and current at the i th harmonic frequency, respectively, and ϕ_i is the corresponding angle between the voltage and current. Equation (1) describes that the active power at different frequencies is isolated from each other and the voltage or current in one frequency has no influence on the active power at other frequencies. The independency of the active power at different frequencies gives the possibility that a converter without power source can generate active power at one frequency and absorb this power from other frequencies.

By applying this method to the DPFC, the shunt converter can absorb active power from the grid at the fundamental frequency and inject the current back into the grid at a harmonic frequency. This harmonic current will flow through the transmission line. According to the amount of required active power at the fundamental frequency, the DPFC series converters generate a voltage at the harmonic frequency, thereby absorbing the active power from harmonic components. Assuming a lossless converter, the active power generated at fundamental frequency is equal to the power absorbed from the harmonic frequency. For a better understanding, Fig. 4 indicates how the active power exchanges between the shunt and the series converters in the DPFC system.

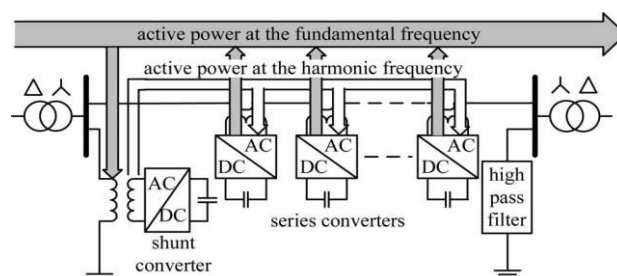

Fig. 4 Active power exchange between DPFC Converters

B. Distributed Series Converter

The D-FACTS is a solution for the series-connected FACTS, which can dramatically reduce the total cost and increase the reliability of the series FACTS device. The idea of the D-FACTS is to use a large number of controllers with low rating instead of one large rated controller. The small controller is a single-phase converter attached to transmission lines by a single-turn transformer. The converters are hanging on the line so that no costly high-voltage isolation is required. The single-turn transformer uses the transmission line as the secondary winding, inserting controllable impedance into the line directly. Each D-FACTS module is self-powered from the line and controlled remotely by wireless or power-line communication (see Fig. 7). The structure of the D-FACTS results in low cost and high reliability. As D-FACTS units are single-phase devices floating on lines, high-voltage isolations between phases are avoided. The unit can easily be applied at any transmission-voltage level, because it does not require supporting phase-ground isolation. The power and voltage rating of each unit is relatively small. Further, the units are clamped on transmission lines, and therefore, no land is required. The redundancy of the D-FACTS provides an uninterrupted operation during a single module failure, thereby giving a much higher reliability than other FACTS devices.

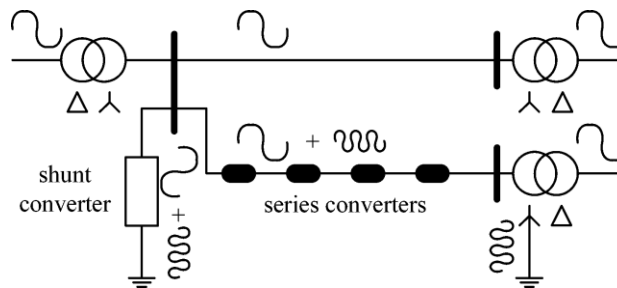

Fig. 5 Distributed Series Converters

C. DPFC Advantages

The DPFC can be considered as a UPFC that employs the DFACTS concept and the concept of exchanging power through harmonic. Therefore, the DPFC inherits all the advantages of the UPFC and the D-FACTS, which are as follows.

- 1) *High control capability:* The DPFC can simultaneously control all the parameters of the power system: the line impedance, the transmission angle, and the bus voltage. The elimination of the common dc link enables separated installation of the DPFC converters. The shunt and series converters can be placed at the most effectively location. Due to the high frequency control capability, the DPFC can also be used to improve the power quality and system stability, such as low-frequency power oscillation damping [8], voltage sag restoration, or balancing asymmetry.
- 2) *High reliability:* The redundancy of the series converter gives an improved reliability. In addition, the shunt and series converters are independent, and the failure at one place will not influence the other converters. When a failure occurs in the series converter, the converter will be short-circuited by bypass protection, thereby having little influence to the network. In the case of the shunt converter failure, the shunt converter will trip and the series converter will stop providing active compensation and will act as the D-FACTS controller [9].
- 3) *Low cost:* There is no phase-to-phase voltage isolation required by the series converter. Also, the power rating of each converter is small and can be easily produced in series production lines. However, as the DPFC injects extra current at the third harmonic frequency into the transmission line, additional losses in the transmission line and transformer should be aware of.

D. DPFC Control

To control multiple converters, a DPFC consists of three types of controllers: central control, shunt control and series control, as shown in Figure 6.

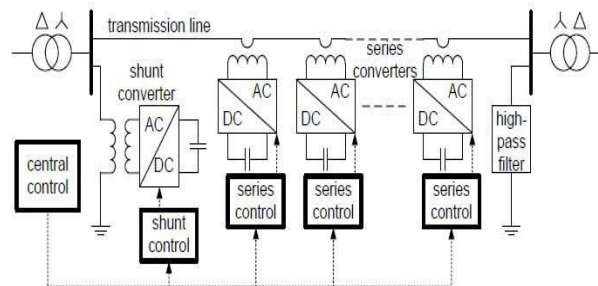

Fig. 6 DPFC control block diagram

The shunt and series control are localized controllers and are responsible for maintaining their own converters parameters. The central control takes care of the DPFC functions at the power system level. The function of each controller is listed:

a) Central control

The central control generates the reference signals for both the shunt and series converters of the DPFC. Its control function depends on the specifics of the DPFC application at the power system level, such as power flow control, low frequency power oscillation damping and balancing of asymmetrical components. According to the system requirements, the central control gives corresponding voltage reference signals for the series converters and reactive current signal for the shunt converter. All the reference signals generated by the central control concern the fundamental frequency components.

b) Series control

Each series converter has its own series control. The controller is used to maintain the capacitor DC voltage of its own converter, by using 3rd harmonic frequency components, in addition to generating series voltage at the fundamental frequency as required by the central control.

c) Shunt control

The objective of the shunt control is to inject a constant 3rd harmonic current into the line to supply active power for the series converters. At the same time, it maintains the capacitor DC voltage of the shunt converter at a constant value by absorbing active power from the grid at the fundamental frequency and injecting the required reactive current at the fundamental frequency into the grid.

IV. SIMULATION & RESULT

In this section for showing better performance of DPFC is considered. This system is three phase. During the disturbance in distribution system sag and swell is occurred in the system depends on the voltage.

The disturbance is occurred at $t=0.2s$ to $t=0.4s$ & at $t=0.6s$ to $t=0.8s$. The DPFC is used to injecting the voltage when sag and swell is occurred.

a) Before installing DPFC

The system considered with voltage sag & voltage swell created using three phase programmable source. The harmonic are introduced by connecting non-linear load with source voltage as 415V, frequency 50Hz.

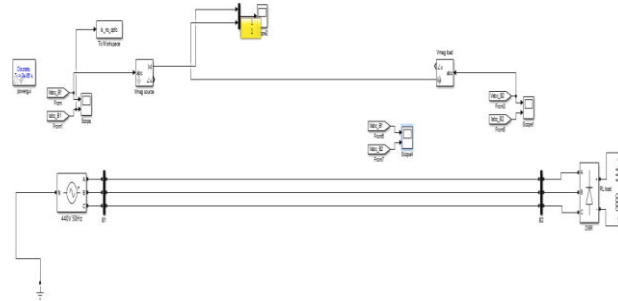

Fig. 7 Simulink model without DPFC system

When disturbance is created in distribution system depends on the voltage variation sag and swell is occurred at the system.

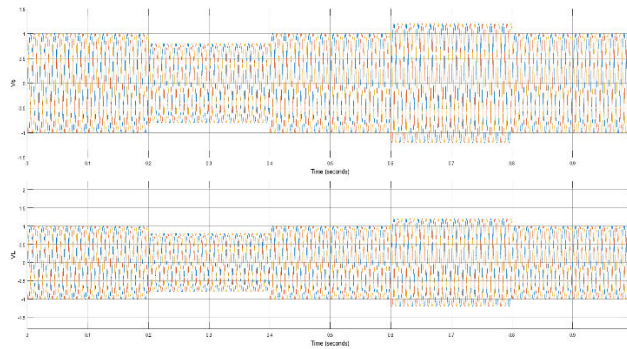

Fig. 8 source and load voltage with sag and swell

The sag and swell created is showing in fig. 8 and fig. 9. The voltage sag is create at time $t=0.2s$ to $t=0.4s$ and the voltage swell is create at time $t=0.6s$ to $t=0.8s$.

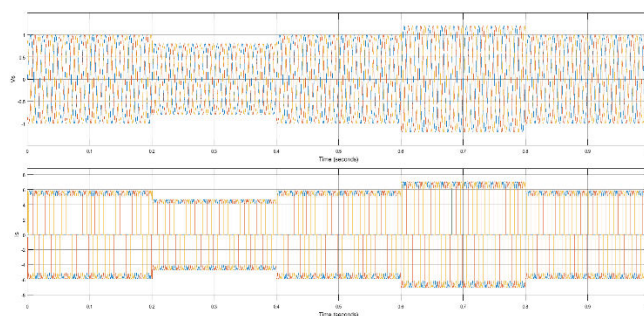

Fig. 9 Voltage source and current source with sag, swell and harmonic distortion

The complete simulation time is 1 sec, sag is created from 0.2s to 0.4s and swell is created from 0.6s to 0.8s. The three phase voltages of source and load can be seen with sag, swell and distortion in waveform of fig.9.

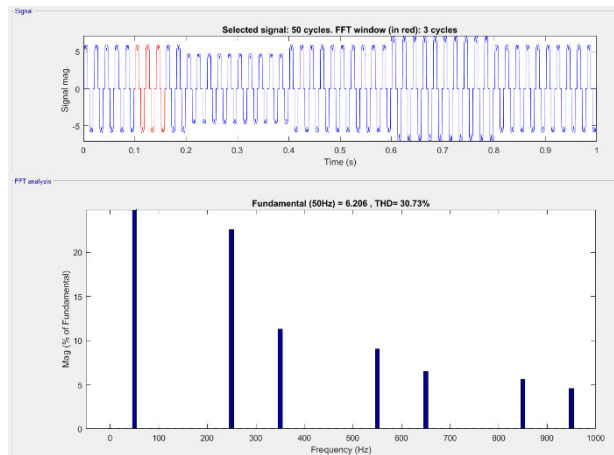

Fig.10 Representation of Total Harmonic Distortion without DPFC

The THD of source current is recorded at 30.73% without DPFC connected in the system.

b) After installing DPFC

The DPFC will be installed at the time voltage is injected to distribution system. The voltage sag and swell will be reduced using DPFC controller. So maintained system performance and also reliability can be improved using DPFC.

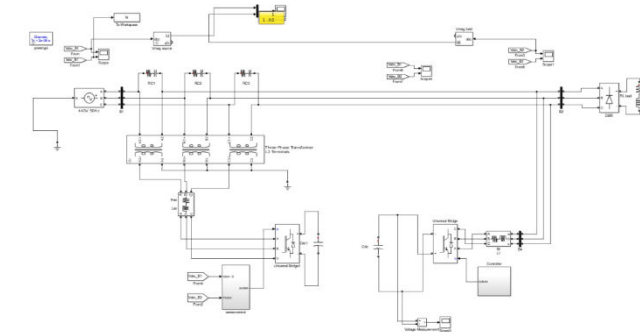

Fig.11 Simulink model with DPFC

The sag and swell will be cleared using DPFC control as shown in Fig.11.

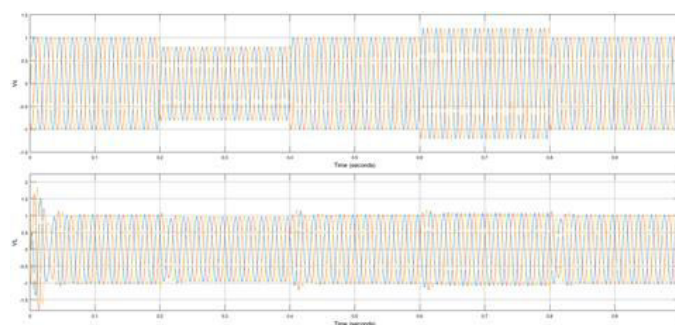

Fig. 12 Source and load voltage with eliminated sag and swell

The sag, swell and distortion is occurred during the time period of $t=0.2s$ to $t=0.4s$ and $t=0.6s$ to $t=0.8s$ respectively, so this can be cleared by using DPFC controller by injecting voltage as 415V, frequency 50Hz, load resistance 100ohm, inductance 5mh. At the time swell voltage will be increased.

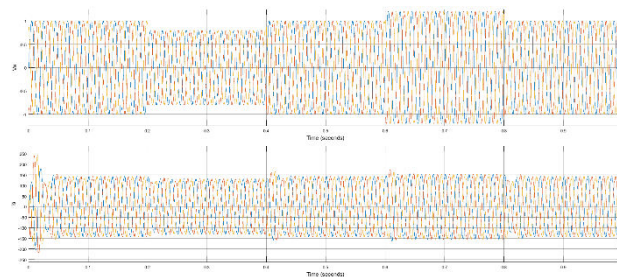

Fig.13 Source current with eliminated harmonic distortion

The sag, swell and harmonic distortion will be cleared using DPFC controller to injecting voltage. So using DPFC control sag, swell and distortion will be eliminated and also reliability can be maintained.

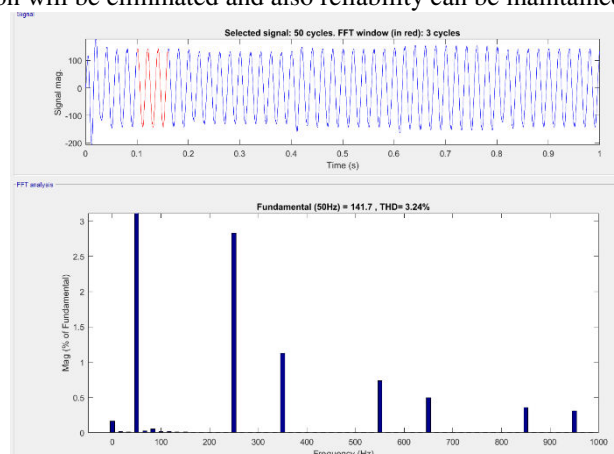

Fig. 14 Representation of Total Harmonic Distortion with DPFC

The total harmonic distortion is recorded as 3.24% with DPFC connected in the system.

V. CONCLUSION

The series converter of the DPFC employs the DFACTS concept, which uses multiple small single-phase converters instead of one large-size converter. It is proved that the shunt and series converters in the DPFC can exchange active power at the third-harmonic frequency, and the series converters are able to inject controllable active and reactive power at the fundamental frequency. The DPFC is also used to improving power quality problems such as sag, swell and harmonic distortion. The reliability of the DPFC is greatly increased because of the redundancy of the series converters. The total cost of the DPFC is also much lower than the UPFC, because no high-voltage isolation is required at the series converter part and the rating of the components of is low.

REFERENCES

- [1] D. Divan and H. Johal, "Distributed facts-A new concept for realizing grid power flow control," in IEEE 36th Power Electron. Spec. Conf. (PESC), 2005, pp. 8–14.
- [2] K K. Sen, "Sssc-static synchronous series compensator: Theory,modeling, and application",IEEE Trans. Power Del., vol. 13, no. 1, pp. 241–246, Jan. 1998.
- [3] L.Gyugyi, C.D. Schauder, S. L.Williams, T. R. Rietman, D. R. Torgerson, and A. Edris, "The unified power flow controller: A new



approach to power transmission control”, IEEE Trans. Power Del., vol.10, no. 2, pp. 1085– 1097, Apr. 1995.

[4] M. D. Deepak, E. B. William, S. S. Robert, K. Bill, W. G. Randal, T. B. Dale, R. I. Michael, and S. G. Ian, “A distributed static series compensator system for realizing active power flow control on existing power lines”, IEEE Trans. Power Del., vol. 22, no. 1, pp. 642–649, Jan. 2007.

[5] M. Mohaddes, A. M. Gole, and S. Elez, “Steady state frequency response of statcom”, IEEE Trans. Power Del., vol. 16, no. 1, pp. 18–23, Jan. 2001.

[6] Y. Zhihui, S.W. H. de Haan, and B. Ferreira, “Utilizing distributed power flow controller (dpfc) for power oscillation damping”, in Proc. IEEE Power Energy Soc. Gen. Meet. (PES), 2009, pp. 1–5.

[7] Y. Zhihui, S. W. H. de Haan, and B. Ferreira, “Dpfc control during shunt converter failure”, in Proc. IEEE Energy Convers. Congr. Expo. (ECCE), 2009, pp. 2727–2732.

[8] Y. Sozer and D. A. Torrey, “Modeling and control of utility interactive inverters”, IEEE Trans. Power Electron., vol. 24, no. 11, pp. 2475–2483,



INNO SPACE
SJIF Scientific Journal Impact Factor
Impact Factor: 8.423



ISSN INTERNATIONAL
STANDARD
SERIAL
NUMBER
INDIA



INTERNATIONAL JOURNAL OF INNOVATIVE RESEARCH

IN SCIENCE | ENGINEERING | TECHNOLOGY

9940 572 462 **6381 907 438** **ijirset@gmail.com**



www.ijirset.com

Scan to save the contact details