



e-ISSN: 2319-8753 | p-ISSN: 2347-6710

IJRSET

International Journal of Innovative Research in
SCIENCE | ENGINEERING | TECHNOLOGY

INTERNATIONAL JOURNAL OF INNOVATIVE RESEARCH

IN SCIENCE | ENGINEERING | TECHNOLOGY

Volume 12, Issue 7, July 2023

ISSN INTERNATIONAL
STANDARD
SERIAL
NUMBER
INDIA

Impact Factor: 8.423

9940 572 462

6381 907 438

ijirset@gmail.com

www.ijirset.com

A Novel Approach to Controlling Parameters of Three-Phase Induction Motor

Mohamad Saad Belwadi, Srishtik G Bhandarkar, Prof.Sudhakar C.J.

Department of Electrical and Electronics, Gogte Institute of Technology, Belagavi, India

ABSTRACT: Every day iot performs an important position in our everyday existence. More than 80% of electromechanical conversion in industrial drives belongs to the Induction Motor (IM) And this wide variety is growing year on year all through the sector as the gadget moved from manual to automatic. However most induction motors are manually operated and cannot be monitored remotely. Induction motor vehicles are also such huge a part of our electric load and now not being able to reveal and control the motor despite the fact that the era exists within the form of iot is disheartening. This paper is at the smart tracking and manipulate of induction motors with the assist of a web application and real-time database. The system proposed here may be used with any existing induction motor that's being controlled Via a VFD. This gadget offers a complete way to reveal and manipulate the motor remotely with only a device that has a browser and a web connection and also to hit upon and expect deviations from everyday running parameters in advance than the superiority of motor failure.

KEYWORDS: ESP32, PZME400T, Static relay.

I. INTRODUCTION

In this modern age, induction motors (IM) are widely used in industry, automotive, Aerospace, military, medical, and domestic equipment and appliances. there are many types of loads as inductive, capacitive and resistive. Therefore all the inductive types of loads ac and dc motors, preferably are extensively used for various industrial applications. In both types of machine, industries mostly commonly use induction machines i.e. Three-phase ims and domestic use single-phase induction motor due to desirable features like robust in construction, low maintenance, low operation cost, high starting torque, highly efficient and reliable. Due to the latest developments in technologies, industries are no longer using the manual methods for monitoring and control of induction motors instead adopting automatic condition monitoring.

In induction motor there are types of fault that occur widely, it is subdivided into three most important parts such as

1. Electrical faults: in electrical fault normally occurs a single phasing fault, reverse phase sequencing fault, oversupply voltage, overload fault, earth fault, etc

2. Mechanical faults: in mechanical fault normally occurs a rotor broken bar fault, stator and rotor winding defect, bearing fault, etc.

3. Environment faults: in environment fault normally occurs the vibration of the motor, induction motor surrounding environment affects the performance of an induction motor such as moisture, temperature, etc this paper involves monitoring of induction motor parameters to assist maintenance before the occurrence of fault. This is the significant advantage of automated monitoring over manual observation, which was responsible for delayed maintenance and process interruptions. The iot will become more prevalent in enabling access to devices and machines in industrial systems. Currently, iot is widely used to enhance our daily lives through the use of smart devices and to automate induction motor (IM) control. This will transform traditional industries into "smart industries" Several parameters must be considered when monitoring the motion of an electric machine. these parameters include vibration, temperature, current, humidity, insulation resistance, sound, pressure, and capacitance. the speed of a three-phase IM is not easily controlled through a nodemcu board and arduino software. the nodemcu board generates a specified-frequency (square wave) whereas the im must be controlled with a sinusoidal wave of high-voltage ac power. combining the nodemcu with a variable-frequency driver (vfd) is a desirable solution for managing the rotation speed of a three-phase im. the advantages of the nodemcu board include ease of implementation, low price, and low power. the nodemcu board performs its functions with a full transmission control protocol (tcp)/ip stack and other peripheral devices essential for data processing. the data is continuously transmitted to real time data base and is displayed on web application. in case of any abnormalities a notification can be sent and the motor is stopped automatically for safety reasons. hence this is a all-round solution for monitoring and controlling of an induction motor.

II. METHODOLOGY AND IMPLEMENTATION

Initially, the requirements to layout this tool are accrued after which layout consideration is taken care. finally, a design process is suggested to design control of a three-phase induction motor. therefore there are various ways of controlling an induction motor over the internet. we will be using an esp32 development board as the brains of the operation which will control the vfd. the vfd will control the speed and direction of the induction motor. the vfd will require a pwm signal to control the speed of the motor and it will be given by the esp32 board. the forward-reverse will be controlled by giving a high or low signal to the fwd/rev pin of the vfd through esp32.

the esp32 board will also collect data such as phase, voltage, current, frequency, and power factor of the induction motor that is connected using a pzem004t module. the web application will be designed using html, css, bootstrap, and javascript. it will feature a login page for security purposes, a dashboard to view the collected data from the pzem004t module, and a temperature sensor and control panel to control the motor. the speed of the motor will be estimated using the frequency of the vfd and will be calibrated accordingly.

the web application is coupled with a firebase - a realtime database. the web application will send and receive data to and from firebase. the firebase data is then sensed by the esp32 board using the firebase api using a firebase application url and a secret key for safety reasons. hence we will be able to control the speed and direction of a motor from anywhere using any network given we are able to login into the web application and also be able to see the status of the motor such as the direction it is running, speed, power, current, power factor, and the temperature on the dashboard.

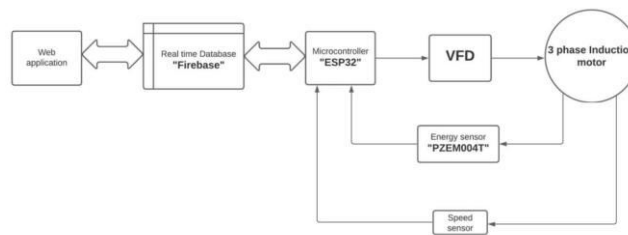

FIG 1. BLOCK DIAGRAM

III. HARDWARE CONCEPT DESIGN

1. SENSORS

A sensor is a device that sensing of a physical phenomenon to produce an output electrical signal in this paper there are three types of sensors that are temperature sensor, speed sensor, energy sensor (pzem004t) temperature is a significant factor in determination of motor condition so sensor is used to determine the parameter of induction motor. speed sensor is used to measure the rotation speed of induction motor whereas energy sensor i.e pzem004t can measure current, voltage, energy, power factor, frequency. all the sensors data are stored in the database through esp32 nodemcu.

2. ESP32 NODMCU

Esp32 is a series of low-power microcontrollers with integrated wi-fi and dual-mode bluetooth. esp32 can perform as a complete standalone system, reducing communication stack overhead on the main application processor. its cost-effective board with 4mb of internal flash memory and required operating voltage is 2.2 to 3.6v. under normal operation the esp32 thing will power the chip at 3.3v programmed using arduino ide software. successfully esp32 easily connect with the other sensors and processed the sensing data the rotation, direction of induction motor can be control or adjust through the mobile application and can be stored into the database.

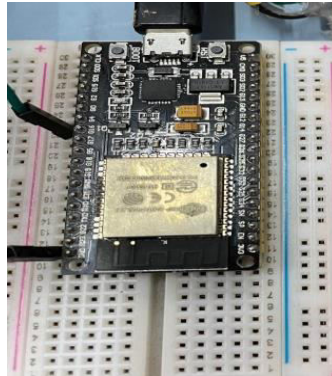

FIG 2. ESP32

3. WEB APPLICATION

In this paper, the web application will be designed using html, css, bootstrap, and javascript and the software also include a web server, arduinoide, and an android app. basically application software that runs on a web server. web applications are accessed by the user through a web browser with an active network connection. firstly the client (web browser) the user type the url in the browser and it generate the http request by the browser and send it to web server the web server is to store web pages and process and answer incoming http requests from clients. a web server supports communication through an http protocol to share web documents. then data is transferred to the real-timedatabase passing through the application server. the obtained data from the rotation motor, and sensors are adjusted in the mobile application and this data is transferred to the real-time database through web server via http through esp32 then the user can access the data stored in the web server. hence we will be able to control the speed and direction of the motor from anywhere using any network given we are able to login into the web application and also be able to see the status of the motor such as the direction in its running, speed, power, current, power factor, on the dashboard. arduino ide is used to write and upload the program to the nodmcu board through c language and the android app is used to develop the app to interface with the motor to directly change the speed of I.



FIG 3. BLOCK DIAGRAM OF ACCESSING DATA FROM DATABASE

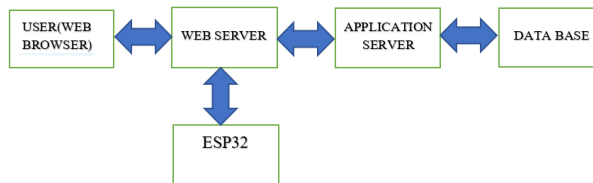

FIG 4. ACCESSING DATA FROM ESP32

4 RELAY MODULE

The relay module is used to govern the motor route forward or reverse.if the signal is fed from esp32 the relay is 1. themrun-in is ahead identical.asim run in opposite whilst relay module is 0. and also relay module is used to start and forestall the motor.

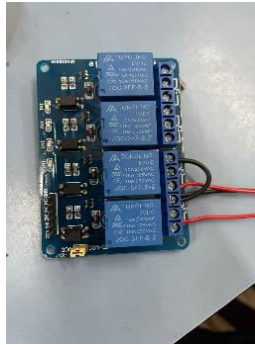
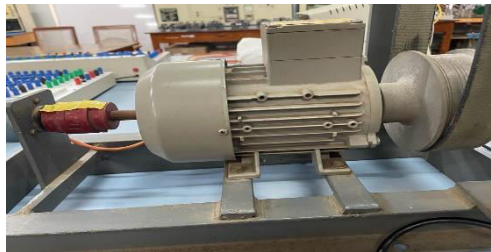

FIG 5. RELAY MODULE

5 INDUCTION MOTOR(3 PHASE)



PARAMETER	RATING	UNIT
Power	0.37	Kw
Imax	1.01	A
Speed	1370	Rpm
Frequency	50	Hz

FIG 6.RATING OF 3PHASE INDUCTION MOTOR

6.VFD RATING

PARAMETER	Specification
Source Power	1PH 200/240v
Source frequency	50/60 Hz
Output Power	3PH 200/240V
Output Frequency	0.5/400Hz

FIG 7. PARAMETER OF VFD

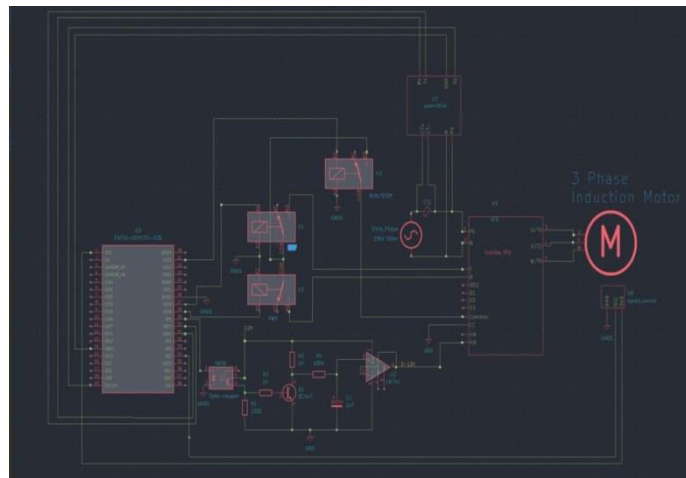

FIG 8. CIRCUIT DIAGRAM OF ESP32 TO VFD

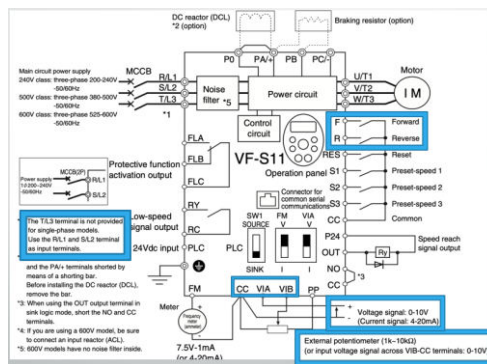

FIG 9. VFD PIN DIAGRAM

Fig 8 shows a circuit diagram of esp32 to vfd, the control strategy determines how the induction motor is being controlled using an iot board and a web application. vfd is being used in the project to control the direction of rotation and the speed of im. according to the datasheet of the vfd providing a signal of 0-10v between the vib and cc pin of the vfd (cc being the common or gnd) will vary the speed of the motor from 0-1500 rpm. we are using an esp32 development board as the brains of our system. esp32 allows us to generate pwm(pulse-width modulation) signal from 0-100% duty cycle which will be 0- 3.3v at the pin of the esp32. the frequency of the pwm signal is chosen to be 5khz. since the vfd requires a signal that varies from 0-10v, an additional circuit with an opto coupler for isolation and an op-amp is used to convert 0-3.3v signals to 0-10v signals required for vfd. to control the direction of rotation, the datasheet recommend sorting the f or r pin to the common pin of the vfd. if f and common pin are connected, the motor spins in a clockwise direction, and if r and common are connected, the motor spins in an anti-clockwise direction. this is achieved using relays. fig 9. indicated the pin diagram of vfd, supply pins, and forward and reverse pins.



FIG 10.1 CONTROL PANEL

FIG 10.2 DASHBOARD PANEL

The above fig10 illustrates the mobile app for controlling 3 phase induction motor. two switches are provided to control the motor fwd and rev and also sliding arrow is provided to control the speed of the motor the application will be designed using Html, CSS, bootstrap, and javascript. it will feature a login page for security purposes, it contains a control panel and a dashboard. the dashboard is used to view the collected data from the pzem004t module to control the motor. the speed of the motor will be estimated using the frequency of the vfd and will be calibrated accordingly. software is coupled with a firebase - a real-time database. the net application will ship and get hold of statistics to and from firebase. the firebase data is then sensed through the esp32 board the usage of the firebase API. the usage of a firebase utility URL and a mystery key for safety reasons. hence, we can be able to control the speed and path of the motor from everywhere using any network given we're able to login to the internet application and additionally be able to see the fame of the motor such as the direction, speed, power, contemporary, powerful on the dashboard.

IV. EXPERIMENTS AND RESULTS

The process of speed control was varied several time with the difference of 200 rpm hence changes in program was done and also faced problem in energy sensor due to encrypt and solved the problem. Below figure shows the Error speed line graph.

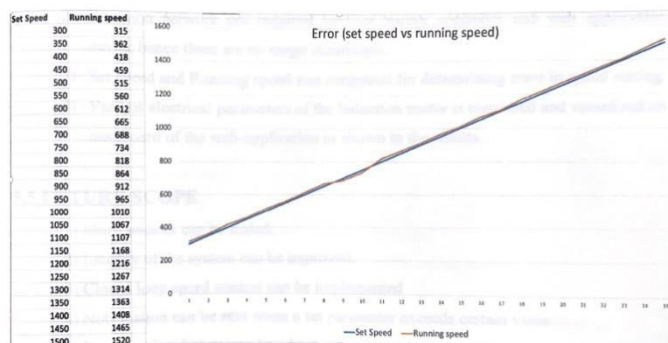

The induction motor was successfully controlled using web application, therefore common network not required between motor controller and web application device hence there are no range constraints nevertheless various electrical parameters of the induction motor is measured and visualized on dashboard of the web application. Also, set speed and running speed was compared for determining error in speed setting

REFERENCES

- [1] S. S. Goundar, M. R. Pillai, K. A. Mamun, F. R. Islam and R. Deo, "Real time condition monitoring system for industrial motors," *2015 2nd Asia-Pacific World Congress on Computer Science and Engineering (APWC on CSE)*, 2015, pp. 1-9, doi: 10.1109/APWCCSE.2015.7476232.
- [2] M. Şen and B. Kul, "IoT-based wireless induction motor monitoring," *2017 XXVI International Scientific Conference Electronics (ET)*, 2017, pp. 1-5, doi: 10.1109/ET.2017.8124386.
- [3] M. R. Belgaum, S. Soomro, Z. Alansari, S. Musa, M. Alam and M. M. Su'ud, "Challenges: Bridge between cloud and IoT," *2017 4th IEEE International Conference on Engineering Technologies and Applied Sciences (ICETAS)*, 2017, pp. 1-5, doi: 10.1109/ICETAS.2017.8277844.
- [4] S. Potturi and R. P. Mandi, "Critical Survey on IOT Based Monitoring and Control of Induction Motor," *2018 IEEE Student Conference on Research and Development (SCORED)*, 2018, pp. 1-6, doi: 10.1109/SCORED.2018.8711222.
- [5] C. -P. Yu, "Internet-of-Things Based Controller of a Three-Phase Induction Motor Using a Variable-Frequency Driver," *2019 IEEE Eurasia Conference on IOT, Communication and Engineering (ECICE)*, 2019, pp. 156-159, doi: 10.1109/ECICE47484.2019.8942676.
- [6] B. Kada, A. Alzubairi and A. Tameem, "Industrial Communication Networks and the Future of Industrial Automation," *2019 Industrial & Systems Engineering Conference (ISEC)*, 2019, pp. 1-5, doi: 10.1109/IASEC.2019.8686664.
- [7] G. Abid, S. A. Shaikh, M. F. Shaikh, S. Hafeez Rajput, U. A. Majeed and A. M. Shaikh, "IOT based Smart Industrial panel for controlling Three-phase Induction motor," *2020 3rd International Conference on Computing, Mathematics and Engineering Technologies (iCoMET)*, 2020, pp. 1-8, doi: 10.1109/iCoMET48670.2020.9073809.



SJIF Scientific Journal Impact Factor

Impact Factor: 8.423



INTERNATIONAL JOURNAL OF INNOVATIVE RESEARCH

IN SCIENCE | ENGINEERING | TECHNOLOGY

 9940 572 462  6381 907 438  ijirset@gmail.com



www.ijirset.com

Scan to save the contact details