



e-ISSN: 2319-8753 | p-ISSN: 2347-6710

IJRSET

International Journal of Innovative Research in
SCIENCE | ENGINEERING | TECHNOLOGY



INTERNATIONAL JOURNAL OF INNOVATIVE RESEARCH

IN SCIENCE | ENGINEERING | TECHNOLOGY

Volume 13, Issue 6, June 2024

ISSN INTERNATIONAL
STANDARD
SERIAL
NUMBER
INDIA

Impact Factor: 8.423

9940 572 462

6381 907 438

ijirset@gmail.com

www.ijirset.com

Comparative Study of Different Flat Slab Structure Under Progressive Collapse

Dr. S K Hirde, Gaurav Ganorkar

Professor & Head, Department of Applied Mechanics, Government College of Engineering, Amravati,
Maharashtra, India

PG Student, Department of Structural Engineering, Government College of Engineering, Amravati Maharashtra, India

ABSTRACT: This review paper presents the progressive collapse analysis of flat slab structures. The progressive collapse of the building occurs when one or more vertical load-carrying structural elements like columns are removed. Once a column is removed due to an extreme load generated either by natural hazards such as earthquake or by manmade like gas explosions, terrorist attacks, etc. In this case the weight of the structure transfers to structural member such as neighbouring columns in the structure. Flat slab buildings are more prone to progressive collapse than moment frame buildings, its behaviour to resist progressive collapse must be examined, since absence of beams to redistribute load due to get more effect after removing columns. mostly research papers explores the different locations for column removal situation in each model at ground storey and the results are analyzed for each case in terms of demand capacity ratio (DCR) at critical sections, vertical joint displacement and chord rotation at column removal locations.

KEYWORDS: RCC flat slab, progressive collapse, perimeter beam, ETABS

I. INTRODUCTION

The collapse of load carrying structural element may lead to progressive collapse as a part or whole structure. According to GSA 2016 guidelines, progressive collapse is defined as extent of damage or collapse that is disproportionate to the magnitude of the initiating event. The progressive collapse initiates, when one or more load carrying members are removed. When one or more load carrying elements remove chain reaction of failures structure start. The guidelines of the GSA and DoD suggested the Alternate Path Method (APM) for progressive collapse analysis where a single column in the ground level is assumed to be unexpectedly missing and analyses are carried out to assess the ability of the weakened structure to pass through the missing column. The alternate load path method (APM) focuses on the vertical deflection of the building after the column has been suddenly removed. The collapsing structure seeks for alternative load path continuously for prevent progressive attention collapse and survive. Traditional design work not considered extreme loading conditions. Previously some experiences grab of structural engineer's attention Ronan point apartment building, Alfred.P. Murrah building, skyline plaza, world trade Centre. Based on the type of collapse occur, progressive collapse divided into pancake-type, zipper-type, domino-type, section-type, instability-type and mixed type collapse. The purpose of this study is to analyses the effect of geometrical irregular RC flat slabs for progressive collapse. progressive collapse analysis where a single column in the ground level is assumed to be unexpectedly missing and analyses are carried out to assess the ability of the weakened structure to pass through the missing column. PCA is classified as PRESSURE LOAD Internal gas explosion, Blast load, Extreme wind pressure and another type is IMPACT LOAD- Aircraft impact, Vehicular collision, Earthquake in this study analyses behaviour of building under column loss at ground floor.

Progressive failure:

A condition where the damage or failure of one element results in the failure of another. Broadly this can be split into horizontal and vertical cases. The former may be caused by surrounding members becoming overloaded, after the loss of an element. Alternatively, vertical failures may occur if one element, possibly an entire floor, falls and lands on a lower element. The additional load, combined with the dynamic impact, causes that element to fail as well, and the failure propagates vertically leading to a pancaking effect. However, the failures may be arrested, and the damage remain localised, with only a few surrounding elements failing.

Flat slab construction:

A form of structure in which a Reinforced Concrete (RC) slab is supported directly on columns, without the use of beams or girders. Column capitals or drop panels may be used. Note that the term ‘flat plate’ used by some writers is considered interchangeable with flat slab throughout this document

Progressive collapse:

A condition where the collapse commences with the failure of one or a few structural components and then progresses over successive other components. Technically a subsection of the previous case, in this instance the progressive failure mechanism is not arrested and results in the collapse of the structure, or a significant part of it.

. II. LITERATURE SURVEY

1] Jinrong Liu ; Ying Tian, M.ASCE ; and Sarah L. Orton, M.ASCE : In this paper a macromodeling approach and alternate path method is used, dynamic and static analyses are performed to assess the progressive collapse resistance of a multistory reinforced concrete flat-plate building lacking structural integrity reinforcement in the slabs. Two loading scenarios, instantaneous removal of an exterior column and interior column, are considered. The dynamic analyses examine the potential of progressive collapse of the building, the dynamic demands on global and local nonlinear deformations, the effects of strain rate in materials, and the development of compressive membrane action. The effectiveness of an energy-based nonlinear static analysis procedure is examined for equivalently estimating the peak dynamic global and local responses caused by sudden column removal. The analyses indicate that older flat-plate buildings are vulnerable to progressive collapse; the combined effects from strain rate and compressive membrane action can significantly increase punching resistance; energy-based nonlinear static analysis can approximate the peak dynamic loading response especially for instantaneous exterior column removal.

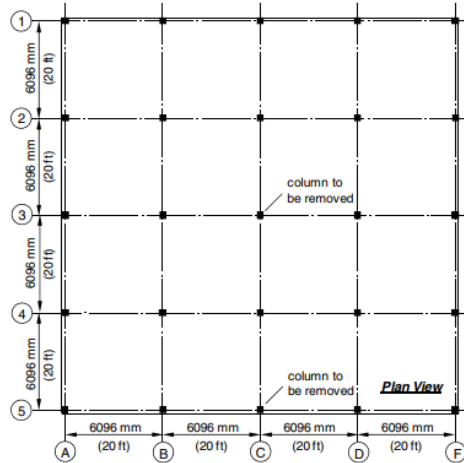

Fig. 1. Prototype flat-plate building floor plan

2] Zhonghua Peng, M.ASCE ; Sarah L. Orton, M.ASCE ; Jinrong Liu, A.M.ASCE ; and Ying Tian, M.ASCE : The researchers have presented experimental results of dynamically removing an interior column in a single-story, 2-bay-by-2-bay reinforced concrete flatplate substructure. The test specimen represented pre-1971 designed flat-plate buildings. The specimen was loaded with dead weight at a load level equal to 78% of the unfactored design load and the support under the interior column suddenly removed by means of a collapsing jack. The test specimen experienced punching failures at four neighboring slab-column connections, but did not fully collapse due to postpunching capacity. Because the gravity load acting on the slab was only slightly greater than a typical service load in a flat-plate building, an older flat-plate building may be at risk for progressive punching failures under a sudden column removal scenario. The measured axial force in two adjacent columns at punching failure was 36% less than the punching load in an isolated column test due to the effects of unbalanced moment, in-plane restraint, and dynamic loading. However, the slab rotation at punching was consistent with predicted rotation capacity and previous test data. The measured lateral expansion of the specimen indicated the presence of compressive membrane forces in the slab at the time of punching

failure. The experimental results validated a macro model developed for simulating the behavior of plate-plate structures.

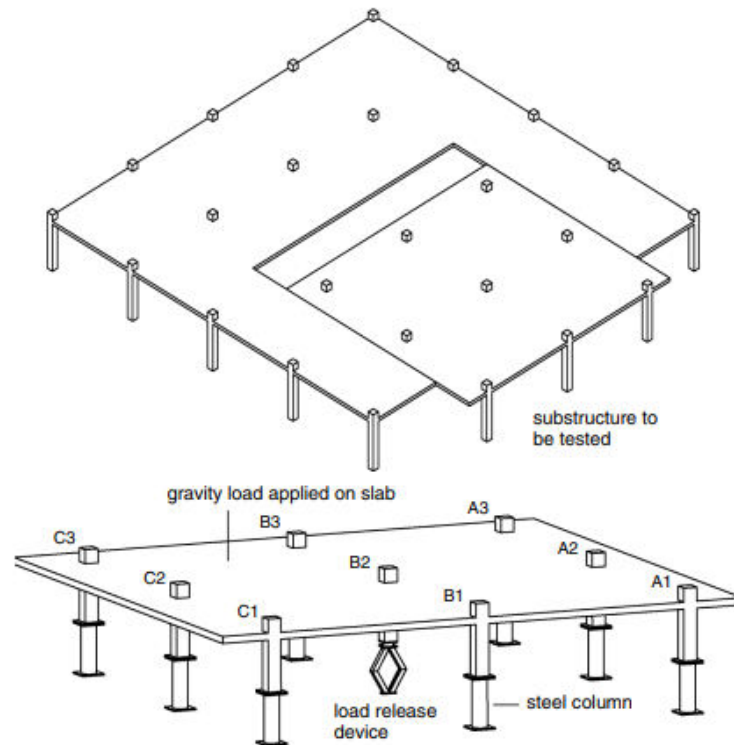

Fig. 2. Schematic model of test specimen.

3] Leila Keyvani, A.M. ; and Mehrdad Sasani, M : In this paper, progressive collapse resistance of an actual posttensioned parking garage is evaluated experimentally and analytically. An interior column was removed by explosion and the structure resisted progressive collapse with a permanent maximum vertical displacement of about 61 mm (2.4 in.). Analytical models of the garage are developed using computer software and nonlinear dynamic analyses are performed. The interaction between the tendon and the slab is modeled explicitly. The analytical results show that despite the fact that the slab around the removed column had no bottom reinforcement and the tendons were placed close to the top of the slab, pushing the slab down, the compressive membrane forces developed in the slab helped increase the flexural strength of the slab sections. The gravity load redistribution is discussed and characterized.

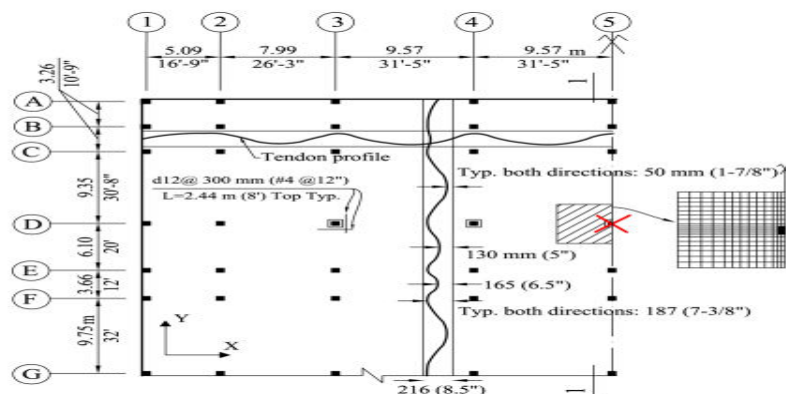

Fig. 3. Plan view of posttensioned parking garage

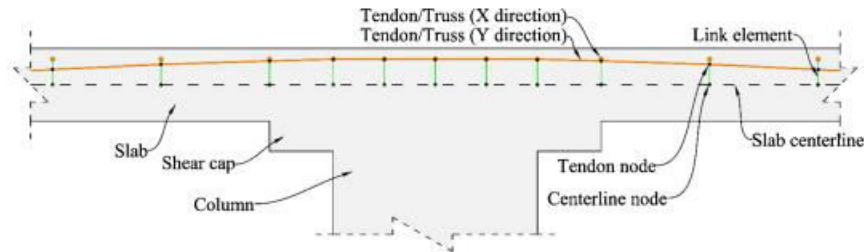

Fig. 4. Two-dimensional view of PT slab showing tendons connected to slab axis by link elements

4]Zhonghua Peng ; Sarah L. Orton,; Jinrong Liu ; and Ying Tian,: This paper documents the findings from a dynamic collapse experiment carried out on a single-story two-by-two bay reinforced concrete flat-plate substructure. The test specimen had a 0.4 scale, represented older flat-plate buildings designed without structural integrity reinforcement in slabs, and was subjected to an instantaneous removal of an exterior supporting column. Tests were conducted three times with different levels of gravity load until a progressive collapse occurred. The specimen survived a gravity load corresponding to 42% of the normal loading capacity defined by the direct design methods but collapsed at a load of 49% of the design loading capacity. The collapse of the specimen was initiated by the punching failure at an interior slab-column connection carrying the most redistributed load after the exterior column removal. The tests confirmed the existence of slab compressive membrane action and examined the strain rates of material under dynamic response. The tests also indicated that a slab-column connection without continuous slab bottom reinforcement through the column has limited post-punching resistance. The experiment indicated that an older flat-plate building is vulnerable to a progressive collapse when it is subjected to a sudden exterior column removal. Numerical simulations of the experiments using a macromodel were conducted and its effectiveness was confirmed.

5]Wei-Jian Yi ; Fan-Zhen Zhang ; and Sashi K. Kunnath, F.ASCE : In a series of experiments on two identical large-scale models, an interior, exterior, and corner column of the structure were replaced by mechanical jacks during the fabrication of the structure. In collapse-resistant design of structures, understanding primary structural failure-mechanisms and alternative load paths under accidental extreme loads is important. A quasi-static experimental method is used to simulate the sudden loss of a column in a single story concrete flat slab-column structure.. After application of uniform loads of increasing intensity, the jack representing the lost column was unloaded. In the first model test wherein an interior column was removed, a downward concentrated load was also applied on the upper end of the interior column until the structure collapsed. Elastic behaviour, yield-line mechanisms, and compressive and tensile membrane actions in the flat slab-column structure were observed during the collapse tests. The results provide valuable information on the load transfer mechanisms in a flat slab-column structure when critical columns are removed.

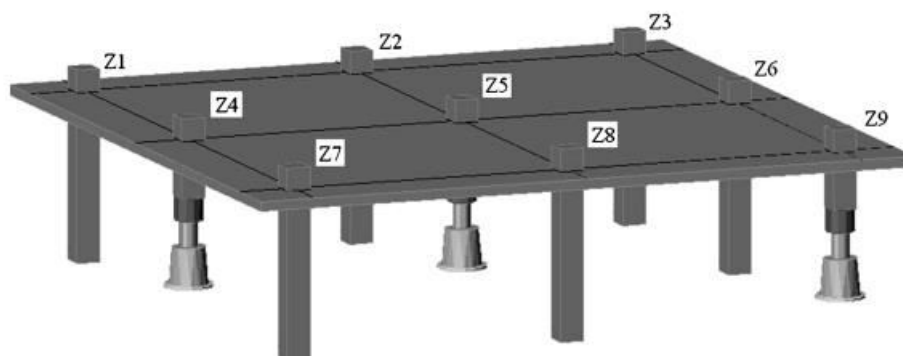
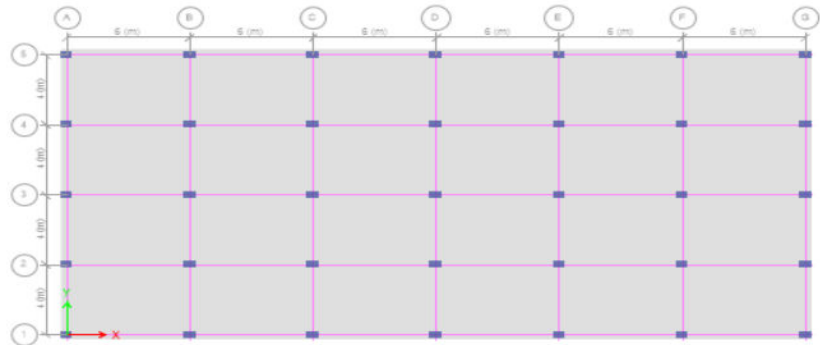

Fig. 5. Schematic view of test models showing simulation of column removals: (a) model 1—interior column loss (Z5); (b) model 2—exterior column loss (Z4) and corner column loss (Z9)

6]J.M. Russella, J.S. Owenb , I. Hajirasouliha: The researchers has analyzed the nonlinear dynamic response of a structure after dynamic column loss event is considered, including the redistribution of loads and displacement profile. These results are then compared to equivalent static cases in order to determine the Dynamic Amplification Factor (DAF). For the range of structures, they considered, the DAF was calculated as between 1.39 and 1.62 for displacements, with lower factors associated with a higher nonlinear response or slower column removal. Additionally, the shear forces in remaining columns may exceed 200% of their fully supported condition, with a different associated DAF. The effects of increasing the tensile strength of concrete due to high strain rates are also considered. They did experiment on FE displacements results against time with different removal times compared to the experimental results. Four different times (0, 20, 50 and 100 MS) are used to reduce the reaction force provided by the temporary support. In this work study is applied experimentally The dynamic response of RC flat slab structures after a column loss demonstrates that a sudden removal can considerably increase the peak displacements and the shear forces compared to the static condition. The DAF for displacement values is related to the extent of damage and nonlinearity within the force displacement response.

7]G. Anandakrishnan , Jiji Antony : Progressive collapse causes the failure of a primary structural member to propagate to the adjoining members, thus causing the collapse of the entire structure. The need to mitigate the impact of progressive collapse is necessary as it leads to catastrophic economic loss and casualties. The flat slab buildings are more prone to progressive collapse due to the absence of beams which are used to transfer the load initially resisted by the removed column. The main cause of failure in a flat slab building is the punching shear failure occurring at the slab column connections. The aim of this study is to investigate the performance of a multistoried flat slab buildings subjected to progressive collapse. Also, the study investigates the effect of drop panel on the progressive collapse of the building and also the impact of progressive collapse of structure designed based on Indian codes for different locations of column removal. The linear static progressive collapse analysis of the flat slab building is done using ETABS.



(a)

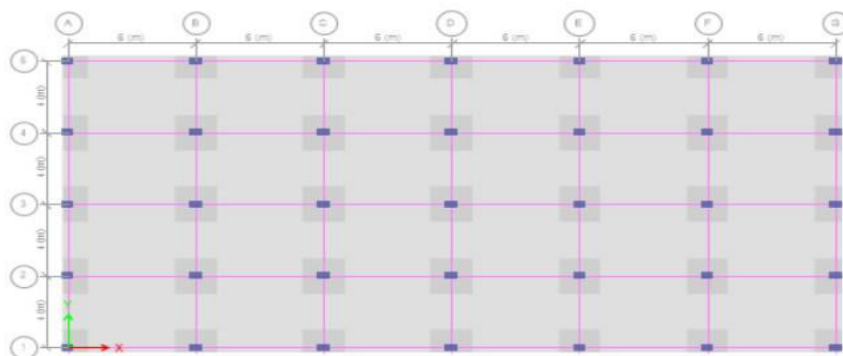

(b)

Fig. 6. Plan of the modelled building a Flat slab building. b Flat slab building with drop

8]Suyash Garg , Vinay Agrawal, Ravindra Nagar : The progressive collapse of buildings could result in significant financial losses and casualties, and it is therefore of the utmost importance to reduce the risks of such occurrences. Flat-slab buildings are much more prone to progressive collapse than moment-frame buildings, since as there are no beams for redistributing the loads that the lost column initially resisted. Even more consideration should, therefore, be given to assessing the progressive collapse of flat-slab buildings. The current analytical research assesses the progressive collapse behaviour of eight-storey R.C flat slab building, with and without perimeter beams, by conducting linear static progressive collapse analysis as per the GSA guidelines (2016). This research explores the column removal situations for various typical positions on each storey, unlike earlier studies where only certain typical columns on the first storey are removed. The results are analyzed for each scenario in terms of joint vertical displacement and chord rotation at column removal locations, and thus the susceptibility of the building to progressive collapse is calculated in compliance with the relevant accepted criteria laid down in the DoD Guidelines (2009). The results showed that the incorporation of perimeter beams in flat slab buildings improved the progressive collapse resistance as it reduces joint displacement and chord rotation at column removal locations by providing sufficient stiffness and load paths for increased gravity loads.

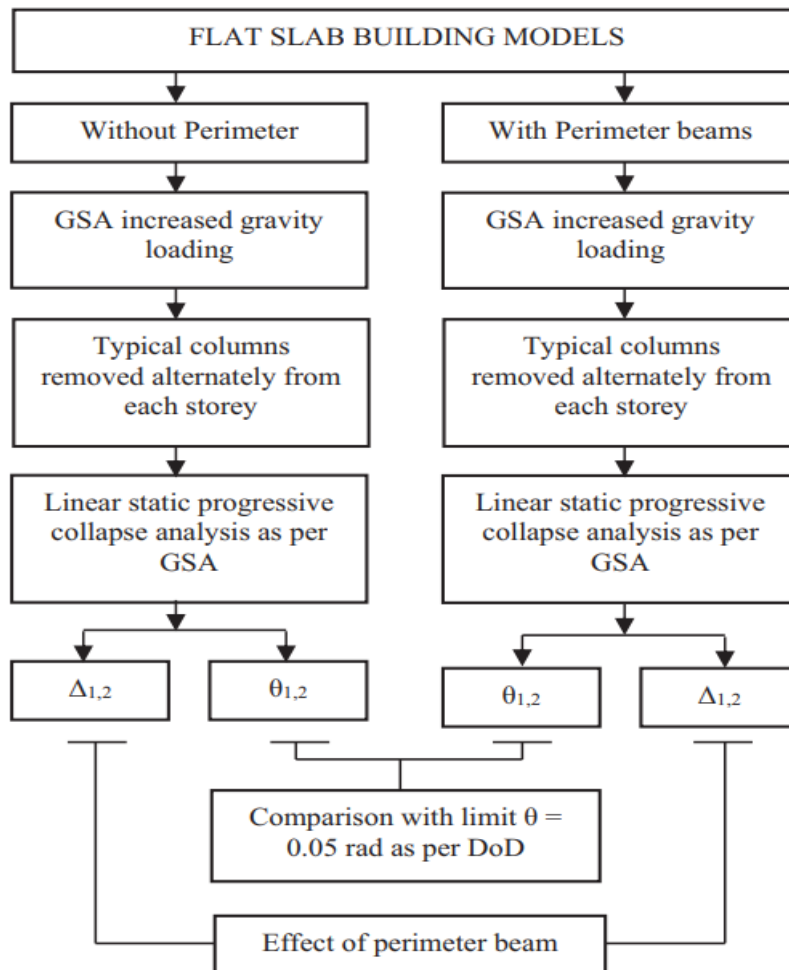

Fig. 7. Flowchart of progressive collapse analysis to assess the behaviour of studied 8-storey flat slab building

9]P. Olmati ^a, J. Sagaseta ^b, D. Cormie ^c, A.E.K. Jones : Flat slab concrete buildings are widely found in infrastructure such as office and residential buildings or industrial facilities. The susceptibility of progressive collapse of such structures due to accidental loads is highly dependent on the structural performance of the slab-column connections. This paper presents a framework for a simplified reliability analysis and derivation of safety factors for computing the probability of punching of flat slab concrete buildings subjected to accidental loads such as column removal, slab

falling from above or blast load. The main advantage of the proposed approach is that it considers in a simple manner, the uncertainty in the gravity load applied in the slab before the accidental event, which affects the inertial effects and demand/capacity ratio in the slab-column connections. Eurocode 2 and the Critical Shear Crack Theory for punching are used and extended to dynamic cases for the assessment of the demand/capacity ratio using computer-based time history finite element simulations. The proposed reliability method is applied to a case study of an existing building showing that the column removal situation is not always critical whereas the slab falling from above is much more detrimental.

III. CONCLUSION

The research studies joint displacement and chord rotation at different column removal locations on each building it is evaluated that flat slab structures are more vulnerable in case of corner column removal than that of edge column removal.

DCR values for column adjacent to removed column is maximum, and as column are far from the removed column the DCR values decreases accordingly; viz. The DCR value will be maximum at adjacent column and minimum at corner column.

Mostly Flat slab on the ground floor of a building when the critical column and inner sides of a building are removed collapsed but does not affect the floor above, because the load on the upper floor moves to a flat slab system on the ground floor of the building. The irregular building structure did not collapse after the removal of the column.

In general, if the structures are designed and detailed with an adequate level of continuity, redundancy, and ductility can develop alternative load paths which in return prevents the loss of an individual member and prevent progressive collapse.

REFERENCES

1. Jinrong Liu¹ ; Ying Tian, M. ; and Sarah L. Orton, M. Resistance of Flat-Plate Buildings against Progressive Collapse. II: System Response Jinrong Liu¹ ; Ying Tian, M. ; and Sarah L. Orton, M. 10.1061/(ASCE)ST.1943-541X.0001295.
2. Zhonghua Peng; Sarah L. Orton, M. ; Jinrong Liu, A.; and Ying Tian, Experimental Study of Dynamic Progressive Collapse in Flat-Plate Buildings Subjected to an Interior Column Removal . DOI: 10.1061/(ASCE)ST.1943-541X.0002106.
3. Leila Keyvani, A.M. ; and Mehrdad Sasani, M. Analytical and Experimental Evaluation of Progressive Collapse Resistance of a Flat-Slab Posttensioned Parking Garage DOI: 10.1061/(ASCE)ST.1943-541X.0001279.
4. Zhonghua Peng ; Sarah L. Orton, ; Jinrong Liu ; and Ying Tian, Experimental Study of Dynamic Progressive Collapse in Flat-Plate Buildings Subjected to Exterior Column Removal DOI: 10.1061/(ASCE)ST.1943-541X.0001865.
5. Wei-Jian Yi ; Fan-Zhen Zhang ; and Sashi K. Kunnath, Progressive Collapse Performance of RC Flat Plate Frame Structures DOI: 10.1061/(ASCE)ST.1943-541X.0000963.
6. J.M. Russella, J.S. Owenb , I., (2019) “dynamic column loss analysis of reinforced concrete flat slab.
7. G. Anandakrishnan & Jiji Antony Progressive Collapse Analysis of a Multistoried Building with Flat Slab https://link.springer.com/chapter/10.1007/978-3-030-80312-4_20
8. Suyash Garg , Vinay Agrawal, Ravindra Nagar, Progressive collapse behaviour of reinforced concrete flat slab buildings subject to column failures in different storeys <https://doi.org/10.1016/j.matpr.2020.07.692>
9. P. olmati, J. sagseta, D.cormie, A.E.K. jones., (2016) “Simplified reliability analysis of punching in reinforced concrete flat slab building under accidental actions”
10. GSA, Design guidelines for new federal Office building and major modernization projects, Progressive Collapse Analysis, The US general service administration, 2016.
11. Is 456:2000, plain and reinforced concrete- code of practice, buero of Indian Standers, new delhi 2000



INTERNATIONAL
STANDARD
SERIAL
NUMBER
INDIA



INTERNATIONAL JOURNAL OF INNOVATIVE RESEARCH

IN SCIENCE | ENGINEERING | TECHNOLOGY

 9940 572 462  6381 907 438  ijirset@gmail.com



www.ijirset.com

Scan to save the contact details