



e-ISSN: 2319-8753 | p-ISSN: 2347-6710

IJRSET

International Journal of Innovative Research in
SCIENCE | ENGINEERING | TECHNOLOGY



INTERNATIONAL JOURNAL OF INNOVATIVE RESEARCH

IN SCIENCE | ENGINEERING | TECHNOLOGY

Volume 13, Issue 6, June 2024

ISSN INTERNATIONAL
STANDARD
SERIAL
NUMBER
INDIA

Impact Factor: 8.423

9940 572 462

6381 907 438

ijirset@gmail.com

www.ijirset.com

Seismic Analysis using Dampers in High Rise Building

Teekam Singh, Javed Ul Islam, Hetram Sharma, Yogesh Kumar Agarwal, Abhinav Aggarwal,
Swarnima, Sumit Saini

Assistant Professor, Department of Civil Engineering, Jaipur Engineering College & Research Centre, Jaipur India

ABSTRACT: This study investigates the results occurring due to the application of dampers, which can help in reducing the influence of seismic radiations on the structure. High rise building affected by ground motion in daily life needs to be supervised its behavior, as this is a common problem for development. The foundation of the building is shaking due to earthquake. The vibration caused by the seismic activities causes the building to vibrate which can cause structural damage. The resistance capacity of building components including columns, beams and other structural elements gets lower ultimately due to the development of lateral stresses due to the transmission of vibrations created at the bottom to the top of the building. The article presents the results of studies on the seismic behaviors of the structures two different dampers i.e Fluid viscous dampers (FVD) and Friction dampers equipped on the structure. According to the current edition of IS 1893 almost all multilayer systems should be studied as three-dimensional system. Building floor plan may be seen as symmetrical. In the present work, response spectrum analysis method is used to compare the FVD and frictional dampers. Results for both G+ 15 structure are been compared in terms of storey displacement, storey drift, storey shear, time period, torsional irregularity.

KEYWORDS: Dampers, Fluid Viscous Damper, Friction Damper, Response spectrum method, Etabs

I. INTRODUCTION

The growing infrastructure leads to great investment and economic development of the society, it is necessary to make them safer against earthquake and let people feel confident in their structures. The striking of earthquake results in moving of ground beneath the building and it displaces the foundation and the lower levels of the structure, sending shock waves to the structure and causing it to move back and forth. The strength of the oscillation depends on two factors, the first being the buildings mass and its stiffness which is the force required to cause a certain amount of displacement. Along with the buildings material type and the shape of the column, the stiffness is largely a matter of height. Shorter buildings are stiffer and shift less while taller buildings are more flexible. In the design of building structures with integration of seismic dampers, the section sizes of structural components and the amount of reinforcement may be reduced so that the seismic performance of the structure remains comparable to a conventional design without dampers under design seismic actions. Dampers is a hydraulic shock absorber to break the shaking of a building during an earthquake. The purpose of this project is to compare between viscous and friction damper under high seismic radiation and also the performance of placement techniques is evaluated on Etabs software. In this paper comparison and result of fluid viscous damper, friction damper with conventional building is analyzed respectively.

Dampers

Dampers is a hydraulic shock absorber to break the shaking of a building during an earthquake. Dampers is a mechanical system which dissipate earthquake energy into specialized devices which deforms or yield during earthquake. They enhance energy dissipation in a structure to which they are installed so that the structure has to absorb lesser amount of earthquake forces. When seismic energy is transmitted through them, dampers absorb part of it, and thus damp the motion of the building. The advancement of computational methods on computers and the use of robust testing facilities have significantly advanced the subject of earthquake engineering. As a result, several damping devices have emerged in the structures, which have the instant impact of raising the critical damping ratio all the way up to 20–30% while also lowering the stresses and strains brought on by earthquakes. This strategy, also referred to as "energy dissipation," can absorb sizable efforts without dampening the structure and guarantee the security of people's lives and property.

The following time-dependent conservation of energy connection helps to clarify this method of seismic energy dissipation:

$$E(t) = E_k(t) + E_s(t) + E_h(t) + E_d(t)$$

where,

E is the absolute energy input from the earthquake motion.

E_k is the absolute kinetic energy;

E_s is the elastic (recoverable) strain energy, and E_h is the irrecoverable energy dissipated by the structural system through inelastic or other forms of actions (viscous and hysteretic);

E_d is the energy dissipated by the supplement damping system and t represents time.

OBJECTIVE OF THE STUDY:

1. To compare the seismic behaviour of G+15 storey high rise building using dampers by **Response Spectrum Method** in high seismic zone.
2. To design the earthquake resistant structure by using **Friction damper** and **Fluid Viscous Damper**.

II. LITERATURE REVIEW

Puneet Sajjan, Praveen Birdar “Study on the effects of viscous damper for RCC frame structure” (2022)

After analyzing the structure and considering static and dynamic values, the magnification is determined. After structural analysis, the results are obtained and compared. Analysis of the bare frame model without dampers yielded a displacement of 29.63 mm and a floor drift of 0.00181 mm. Observations show that the displacement value increases with the height of the structure. By comparison, applying a viscous damper to a structure reduces the displacement values of the structure.

Manjeet Dua (2018) performed an analysis on a (G+15) storey building frame in Seismic zone-II using STAAD Pro V8i and compared the displacements observed in model once with shear wall and again without shear wall at different locations. It was observed that the best location of shear wall in multi storey building is near the core of the building. By providing shear wall, the structural seismic behaviour will be affected to a great extent and hence the strength and stiffness of building will be increased.

MD. Samdhani Azad (2016), this study plays attention on the seismic behaviour of structure with steel braced as well as with shear walls. Analysis has done in ETABS software to conclude the different type of behaviour. In their results they have shown comparison of Different models for maximum displacement and storeys drift. They concluded that model, having shear wall in the middle among all the model is the safest.

III. METHODOLOGY

3.1 Types of Dampers

3.1.1 Fluid Viscous Damper:

It resists motion caused by a viscous fluid moving from one area to another. Silicon base fluid moving between piston cylinder configurations absorbs seismic energy. Dissipation of energy is the viscous damper's main principle. In the damper system, fluid moves from a bigger to a smaller area. Viscous dampers can work in environments with temps between 40 and 70 degrees Celsius. In the past 30 years, important civil structures have used viscous dampers (VD) to lessen the effects of earthquakes. Their use in high-rise buildings built in seismic areas is a challenge for the designers, since they should reduce the vibrations induced by both strong winds and earthquakes, and the optimal behaviors in these two situations is not usually the same. Consequently, the design requirement for VD to be used in high-rise buildings is often that they should have two different behaviors in the different range of velocities corresponding to wind and earthquake.

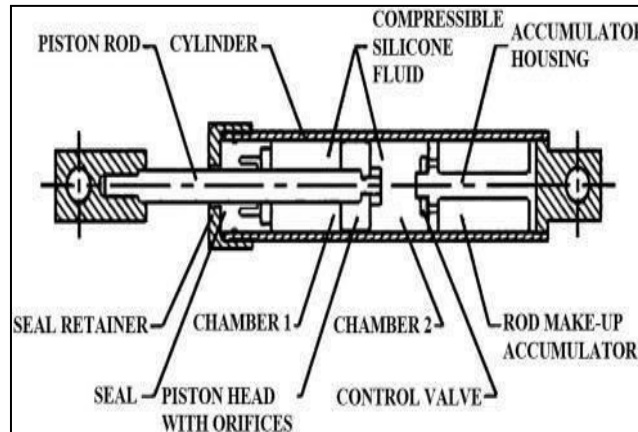

Figure 1: Cross Section of Fluid Viscous Damper

3.1.2 Friction Dampers:

Friction dampers are steel struts that absorb the enormous Charbel Mrad, Magdalini Titirla, Walid Larbi “Optimal Design of Viscous and Friction Dampers in Symmetric Reinforced Concrete Buildings” (2022) In this paper a evaluation of the seismic overall performance of 3 symmetric in plan strengthened concrete (RC) homes strengthening with viscous or friction dampers are provided. An review of the most efficient layout of Viscous and Friction dampers is described. The 3 homes (a four-storey building, a nine- storey building, and a sixteen-storey building) had been subjected to seven (actual and artificial) seismic recorded accelerograms. Nonlinear dynamic time records analyses had been carried out. The results of every strengthening answer are provided in phrases of the most horizontal displacement on the energy generated during an earthquake. These are a type of seismic dampers that consist of an array of inclined steel plates that slide against each other in an inclined position. Friction blocks are used between such steel plates. Maintenance of these dampers is done by regular painting. The friction surface is fixed with a preload block. Exhibits perfect rectangular hysterical behaviour. It is called a path dependent system because the amount of energy dissipated is proportional to the path. Dampers make buildings vibrate elastically and dissipate seismic energy. This in turn produce substantial savings as structural elements can be optimized for cost savings. The plates are specially treated to increase the friction between them.



Figure 2: Friction Damper

3.2 Dynamic Analysis Method

The primary goal of structural analysis is to ascertain how a physical structure will respond to force. For all buildings, excluding regular buildings lower than 15 m in Seismic Zone II, linear dynamic analysis must be done to determine the design lateral force (design seismic base shear, and its distribution to different levels along the height of the building, as well as to various lateral load resisting elements.

In turn, dynamic analysis can be performed in three ways, namely:

1. Response Spectrum Method
2. Modal time History Method
3. Time History Method

3.3 Response Spectrum Method

The modal method or mode superposition approach are other names for this technique. It is predicated on the notion that a structure reacts by superimposing the reactions of various vibrational modes, each of which exhibits a unique distorted shape, frequency, and modal damping. Response spectrum method may be performed for any building using the design acceleration spectrum, or by a site-specific design acceleration spectrum. All mentioned data for RCC buildings is analysed as per Indian code which are IS: 456-2000 and IS: 875-1987. Theseismic load and response spectrum analysis of different models are carried out using STAAD-Pro Connect edition. The load combinations considered in seismic analysis are done as per IScode 1893-2016. Response spectrum method may be performedfor any building using the design acceleration spectrum.

3.4 DESIGN CONSIDERATION AND MODELS OF THE BUILDING

In the present study, analysis of G+15 stories building in Zone V is carried out in ETABS. Basic parameters considered for the analysis are

1. Utility of building: Residential Building
2. No. of Storey : 16 Stories
3. Grade of Steel : Fe415
4. Grade of Concrete : M35
5. Type of Soil : Loose Soil (Type III)
6. Plot Area : 614.43 m²
7. Total Built Up Area : 7301.47 m²
8. For Stories 1-6:
9. Column Size: C1- 400mm X 700 mm C2- 650mm X 850mm
10. Main Beam Size : 600 mm X 400 mm
11. Secondary Beam : 450 mm X 300 mm
12. Slab Thickness : 125 mm
- For Stories 7-15:
13. Column Size: C3 – 300 mm X 500 mm C4 – 450mm X 650mm
14. Main Beam Size : 600 mm X 400 mm
15. Secondary Beam : 450mm X 300mm
16. Slab Thickness : 125mm
17. Shear Wall thickness: 400mm
18. Dead Load : Self Weight
19. Live Load : 4 kN/m²
20. Floor Finish : 1 kN/m²
21. Earthquake Load : As per IS 1893:2016
22. Seismic Zone Factor : 0.36
23. Response reduction factor : 5
24. Importance Factor : 1.5
25. Method of Analysis: Response spectrum analysis
26. RCC design code: IS 456:2000
27. Earthquake design code : IS 1893:2016

3.5 BUILDING PLAN

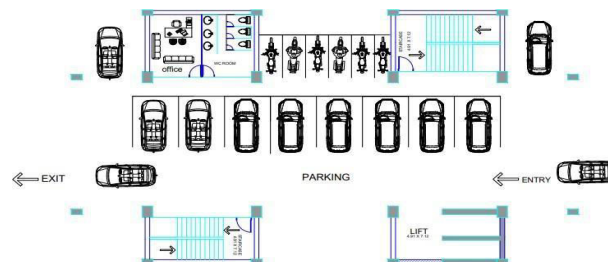

Figure 3: Ground Floor Plan

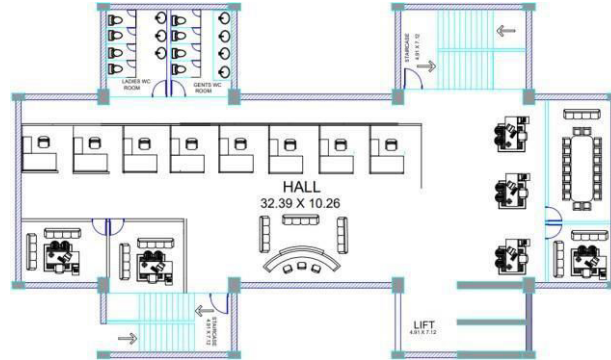

Figure 4: 1-15 Floor Plan

3.6 Models in ETABS

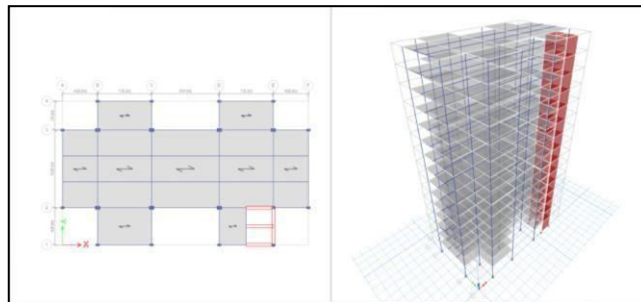

Figure 5: Building Model without dampers

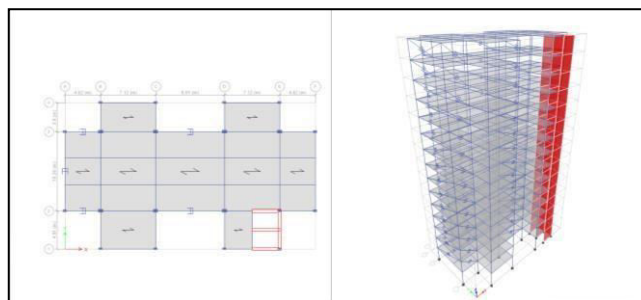

Figure 6: Building with friction damper

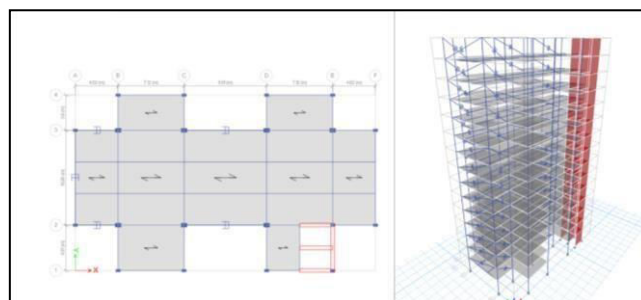
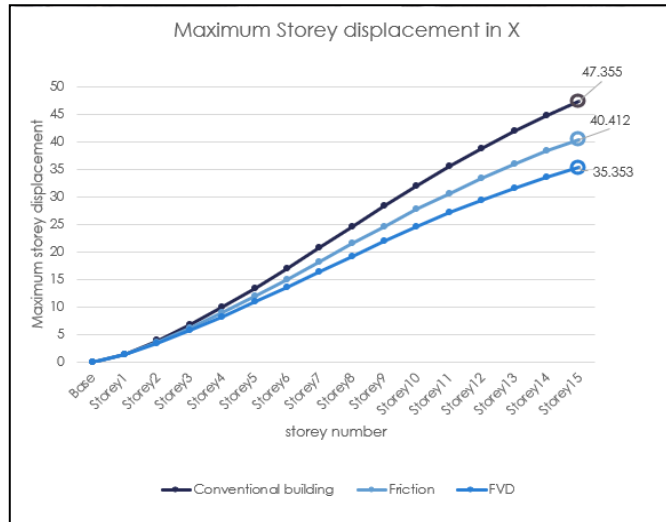
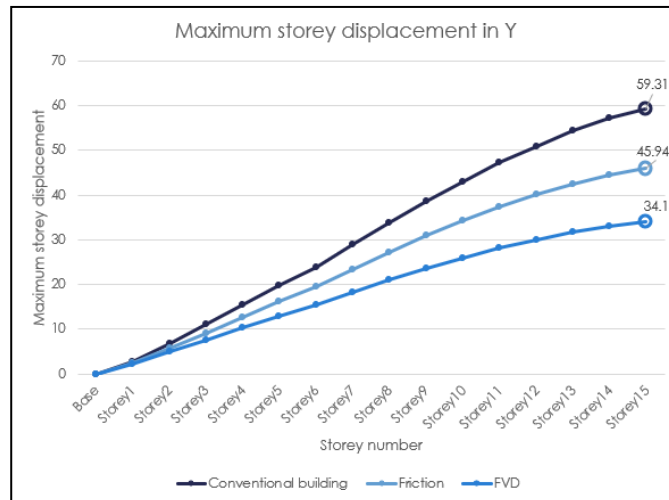

Figure 7: Building model with fluid viscous damper

IV. RESULT ANALYSIS



Maximum Storey Displacement in RSA Y direction



Maximum Storey Drift in RSA Y direction

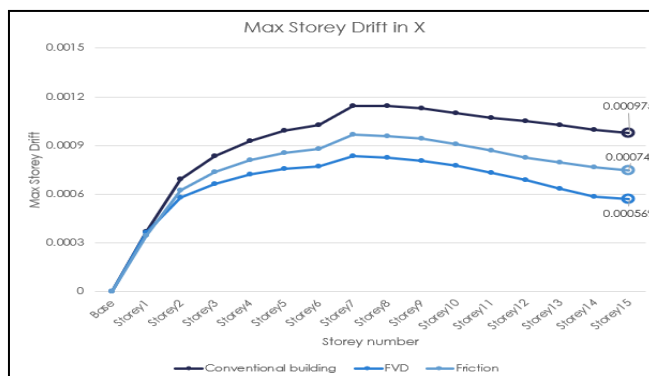

Maximum Storey Drift in RSA X direction

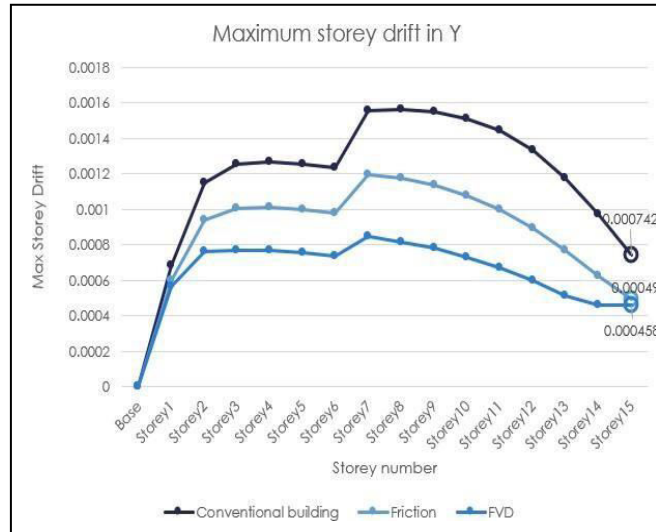

Modal Participating Mass Ratios(Conventional Building)

| Mode | Period sec | UX | UY | RZ | Sum UX | Sum UY | Sum RZ |
|-----------------------|---------------|---------------|---------------|--------------|-----------|-----------|-----------|
| 1 | 2.498 | 0.0645 | 0.4202 | 0.2549 | 0.0645 | 0.4202 | 0.2549 |
| 2 | 1.682 | 0.5885 | 0.0879 | 0.0013 | 0.653 | 0.5081 | 0.2562 |
| 3 | 1.238 | 0.0358 | 0.1567 | 0.461 | 0.6887 | 0.6647 | 0.7172 |
| 4 | 0.827 | 0.0145 | 0.0977 | 0.0326 | 0.7033 | 0.7624 | 0.7498 |
| 5 | 0.475 | 0.0133 | 0.0109 | 0.0212 | 0.7165 | 0.7733 | 0.771 |
| 6 | 0.427 | 0.1338 | 0.0334 | 0.0022 | 0.8504 | 0.8067 | 0.7732 |
| 7 | 0.317 | 0.0039 | 0.0104 | 0.0078 | 0.8542 | 0.8171 | 0.781 |
| 8 | 0.267 | 0.0053 | 0.0781 | 0.1176 | 0.8595 | 0.8952 | 0.8986 |
| 9 | 0.236 | 0.0022 | 0.0107 | 0.0038 | 0.8617 | 0.9059 | 0.9024 |
| 10 | 0.187 | 0.0444 | 0.0024 | 0.0002 | 0.9061 | 0.9082 | 0.9026 |
| 11 | 0.185 | 0.0098 | 0.0115 | 0.0048 | 0.9159 | 0.9198 | 0.9074 |
| 12 | 0.149 | 0.001 | 0.0028 | 0.0026 | 0.9169 | 0.9226 | 0.91 |
| Summation of 12 Modes | | | | | 91.69% | 92.26% | 91.00% |

Mode no.1 has maximum mass participation in translational Y direction with 42.02% and Time Period of 2.498 sec. Mode No.2 has maximum mass participation in translational X direction with 58.85% and Time Period of 1.682 sec. Mode No.3 has maximum mass participation in rotational Z direction with 46.10% and Time Period of 1.238 sec. Maximum mass participation for summation of 12 modes is 92.26% in Translational Y direction.

Modal Participating Mass Ratios (Friction Dampers)

| Mode | Period sec | UX | UY | RZ | Sum UX | Sum UY | Sum RZ |
|-----------------------|---------------|---------------|--------------|---------------|-----------|-----------|-----------|
| 1 | 2.271 | 0.066 | 0.447 | 0.2399 | 0.066 | 0.447 | 0.2399 |
| 2 | 1.604 | 0.5829 | 0.096 | 0.0045 | 0.6489 | 0.543 | 0.2444 |
| 3 | 1.226 | 0.046 | 0.132 | 0.4789 | 0.6949 | 0.675 | 0.7233 |
| 4 | 0.754 | 0.0149 | 0.0925 | 0.0297 | 0.7098 | 0.7675 | 0.753 |
| 5 | 0.436 | 0.0246 | 0.0054 | 0.0196 | 0.7343 | 0.7729 | 0.7726 |
| 6 | 0.415 | 0.1178 | 0.0376 | 0.0035 | 0.8521 | 0.8105 | 0.7761 |
| 7 | 0.293 | 0.0037 | 0.0111 | 0.0066 | 0.8558 | 0.8215 | 0.7827 |
| 8 | 0.267 | 0.0058 | 0.077 | 0.1173 | 0.8616 | 0.8985 | 0.9 |
| 9 | 0.221 | 0.0019 | 0.0091 | 0.0041 | 0.8635 | 0.9076 | 0.9041 |
| 10 | 0.184 | 0.053 | 0.0092 | 0.0004 | 0.9166 | 0.9168 | 0.9045 |
| 11 | 0.174 | 0.0002 | 0.0044 | 0.0042 | 0.9168 | 0.9212 | 0.9086 |
| 12 | 0.141 | 0.0009 | 0.0026 | 0.0024 | 0.9177 | 0.9238 | 0.911 |
| Summation of 12 Modes | | | | | 91.77% | 92.38% | 91.1% |

Mode no.1 has maximum mass participation in translational Y direction with 44.70% and Time Period of 2.271 sec. Mode No.2 has maximum mass participation in translational X direction with 58.29% and Time Period of 1.604 sec. Mode No.3 has maximum mass participation in rotational Z direction with 47.89% and Time Period of 1.226 sec. Maximum mass participation for summation of 12 modes is 92.38% in Translational Y direction. Modal Participating Mass Ratios(Fluid Viscous Damper)

| Mode | Period | UX | UY | RZ | Sum UX | Sum UY | Sum RZ |
|-----------------------|--------|---------------|---------------|---------------|--------|--------|--------|
| | sec | | | | | | |
| 1 | 1.898 | 0.0631 | 0.5222 | 0.1802 | 0.0631 | 0.5222 | 0.1802 |
| 2 | 1.461 | 0.5614 | 0.1029 | 0.0293 | 0.6245 | 0.6251 | 0.2095 |
| 3 | 1.188 | 0.0806 | 0.065 | 0.5241 | 0.7051 | 0.6901 | 0.7336 |
| 4 | 0.625 | 0.0165 | 0.0887 | 0.0252 | 0.7216 | 0.7788 | 0.7588 |
| 5 | 0.391 | 0.1338 | 0.0257 | 0.0002 | 0.8553 | 0.8045 | 0.759 |
| 6 | 0.359 | 0.0002 | 0.0152 | 0.0257 | 0.8555 | 0.8198 | 0.7847 |
| 7 | 0.264 | 0.0085 | 0.0785 | 0.1093 | 0.864 | 0.8982 | 0.894 |
| 8 | 0.246 | 0.0027 | 0.0065 | 0.0103 | 0.8667 | 0.9048 | 0.9043 |
| 9 | 0.187 | 0.0014 | 0.0069 | 0.0037 | 0.8681 | 0.9117 | 0.908 |
| 10 | 0.177 | 0.0505 | 0.0104 | 0.0003 | 0.9186 | 0.9221 | 0.9082 |
| 11 | 0.149 | 0.0005 | 0.0027 | 0.0035 | 0.9191 | 0.9248 | 0.9117 |
| 12 | 0.123 | 0.0008 | 0.0021 | 0.002 | 0.9199 | 0.9269 | 0.9137 |
| Summation of 12 Modes | | | | | 91.99% | 92.69% | 91.37% |

Mode No.1 has maximum mass participation in translational Y direction with 52.22% and Time Period of 1.898 sec. Mode No.2 has maximum mass participation in translational X direction with 56.14% and Time Period of 1.461 sec. Mode No.3 has maximum mass participation in rotational Z direction with 52.41% and Time Period of 1.188 sec. Maximum mass participation for summation of 12 modes is 92.69% in Translational Y direction. Torsional Irregularity Check

| Function | Conventional building | Friction Damper | Fluid viscous damper |
|----------|-----------------------|-----------------|----------------------|
| RESP X | 1.10 | 1.059 | 1.051 |
| RESP Y | 1.51 | 1.39 | 1.31 |

V CONCLUSION

From the above study the comparison is made between the convention building, and building with fluid viscous dampers and building with Friction damper

1. It is seen that the response spectrum analysis in X direction, the storey displacement in building with fluid viscous damper as compared to the building without damper is reduced by 25% and when compared with the Friction damper it is reduced by 15%
2. The response spectrum analysis in Y direction, shows that the storey displacement by application of fluid viscous damper is reduced by 42% and by friction damper it is reduced by 23%
3. Through the analysis carried out using the Response Spectrum Method, the storey drift in X direction in building provided with Fluid viscous dampers as compared to building without dampers (conventional building) is reduced by 42% and when compared with Friction dampers, the storey drift in similar direction is reduced by 23%.
4. Through the analysis carried out using the Response Spectrum Method, the storey drift in Y direction of the building provided with Fluid viscous dampers as compared to building without dampers (conventional building) is reduced by 38% and when compared with Friction dampers, the storey drift in similar direction is reduced by 34%.
5. Maximum storey displacement is observed in conventional building followed by the building equipped with friction damper and the lowest displacement is observed in building equipped with Fluid viscous damper (FVD).
6. Maximum storey drift is observed in conventional building followed by the building equipped with friction damper and the lowest storey drift can be observed in building equipped with Fluid viscous damper (FVD).
7. Therefore, we can conclude our analysis by saying that building equipped with FVD proves to be sustainable in

- seismic condition as compared to building equipped with friction damper and any other conventional building.
8. The torsional irregularity check in building with FVD is observed to be safe in comparison to the building equipped with friction damper and the conventional building.

REFERENCES

1. Ankit Jain, Dr. R. S. Talikoti, "Performance of High Rise Structure with Dampers at Different Location", July-2016
2. , ISSN: 2278-0181.
3. Abhishek Kumar Maurya, V.K. Singh "Analysis of building using viscous dampers in seismic zone-v" , Jun.-2018, ISSN:2394-2827.
4. Charbel Mrad1, Magdalini Titirla, Walid Larbi " Optimal Design of Viscous and Friction Dampers in Symmetric Reinforced Concrete Buildings", April 10 – 12, 2022, PaperNo. ICSECT 149.
5. J.K. Whittle, M.S. Williams, T.L. Karavasilis, A. Blakeborough "A Comparison of Viscous Damper Placement Methods for Improving Seismic Building Design" May 2012,
6. A. Ras *, N. Boumechra "Seismic energy dissipation study of linear fluid viscous dampers in steel structure design" 11 July 2016
7. Sairam Baikhan, Nikhil Kumar "Experimental Investigation of (G+7) Building Using Viscous Dampers January 2020"
8. Hassan Moghaddam , Farshad Afzalnia , Iman Hajirasouliha "Optimal distribution of friction dampers to improve the seismic performance of steel moment resisting frames", 4 January 2022.
9. Naga Dheeraj Kumar Reddy Chukka, Muthumani Krishnamurthy, "Comparison of X-shaped metallic dampers with fluid viscous dampers and influence of their placement on seismic response of the building", 7 May 2019.



INTERNATIONAL
STANDARD
SERIAL
NUMBER
INDIA



INTERNATIONAL JOURNAL OF INNOVATIVE RESEARCH

IN SCIENCE | ENGINEERING | TECHNOLOGY

 9940 572 462  6381 907 438  ijirset@gmail.com



www.ijirset.com

Scan to save the contact details