



e-ISSN: 2319-8753 | p-ISSN: 2347-6710

IJRSET

International Journal of Innovative Research in
SCIENCE | ENGINEERING | TECHNOLOGY



INTERNATIONAL JOURNAL OF INNOVATIVE RESEARCH

IN SCIENCE | ENGINEERING | TECHNOLOGY

Volume 13, Issue 6, June 2024

ISSN INTERNATIONAL
STANDARD
SERIAL
NUMBER
INDIA

Impact Factor: 8.423

9940 572 462

6381 907 438

ijirset@gmail.com

www.ijirset.com

IOT Based Emergency Alert System for Patients

Dr. A R Jayasudha Ph.D , Balakrishnamoorthy S

HOD, Department of Master of Computer Applications, Hindusthan College of Engineering and Technology,
Coimbatore, India

II MCA Students, Department of Master of Computer Applications, Hindusthan College of Engineering and
Technology, Coimbatore, India

ABSTRACT: This project entitled "IOT BASED EMERGENCY ALERT SYSTEM FOR PATIENTS", showcases an Internet of things application that hospital's patients will require assistance at any time. If the patient experiences an emergency at night or on an occasion when no one else is nearby. This project was created in order to prevent those issues. In this project, we constructed a sound box with an Arduino Uno microcontroller and a sound sensor. The mobile phone of the supervising nurse was linked to the microcontroller. In the event of an emergency, the patient only needs to snap close to the sound box or make a sound near it to alert the linked device.

I.INTRODUCTION

This project is in line with the overarching objective of using technology to make healthcare settings smarter and more responsive, which will eventually enhance patient outcomes. The system's use of sound sensors allows it to identify particular audio patterns linked to emergencies or states of distress, allowing for a proactive approach to patient care. The ESP32 and sound sensors communicate seamlessly thanks to the incorporation of IoT principles, allowing the system to send alerts to pertinent stakeholders in real time. The Emergency Alert System promotes proactive monitoring over reactive response tactics, bringing about a paradigm shift in the healthcare system. This initiative is a demonstration of the transformative potential of technology in addressing important areas of patient safety, as well as an inventive use of IoT in healthcare. As the medical field adopts,

1.1 ELECTRONICAL GADGET:

The Patient Emergency Alert System makes use of state-of-the-art technology to offer a prompt and preventive medical solution. By combining an ESP32 microcontroller with a sound sensor, this system may identify emergency sounds or distress signs in a patient's surroundings by continuously monitoring and analyzing auditory cues. The brains of the operation are the ESP32, a strong and adaptable microcontroller that processes sound sensor data with ease and effectively sends out timely notifications when possible emergencies are identified. This combination of hardware highlights how IoT and reliable analysis tools may transform patient care by enabling quick reactions in emergency scenarios.

1.2 REVIEW:

India, with its varied healthcare system, India has particular difficulties in delivering prompt medical care, particularly in an emergency. A rising body of research indicates that using IoT technologies to improve healthcare services is of interest. The application of IoT in healthcare for patient monitoring and emergency response is covered by Patel et al. (2018) in their study, with a focus on how it may enhance patient outcomes in environments with limited resources.

1.3 PROBLEM DESCRIPTION:

For the sake of patients in medical settings, prompt emergency response is essential. However, the responsiveness of conventional emergency alarm systems may be constrained and precision. Individuals who are patients, especially those with restricted movement or speech skills, could find it difficult to properly communicate crises. This calls for the creation of a more dependable and effective solution. By utilizing IoT technology—more especially, sound sensors and the ESP32 microcontroller—to construct an intelligent emergency alarm system, the suggested project seeks to address this problem. By ensuring that patients receive timely assistance when needed, this system aims to improve the accuracy and speed of emergency response in healthcare settings, thereby improving patient safety and healthcare efficiency.

1.4 GOAL:

An Internet of Things (IoT)-based patient emergency alert system aims to give patients real-time monitoring and fast reaction times in case of medical emergencies. The Internet of Things (IoT) is used by this system to continuously gather crucial health data from patients, including heart rate, blood pressure, and oxygen levels. The system immediately notifies designated caretakers or medical professionals in the event of an anomaly or emergency situation, such as a sudden drop in vital signs or a collapse. Quick action and medical help are made possible by this timely communication, which may enhance patient outcomes and speed up response times in emergency situations. By integrating IoT devices and connectivity, the main goal is to improve patient safety and enable prompt medical intervention.

II. SYSTEM SPECIFICATION

2.1 HARDWARE REQUIREMENTS:

- | | | |
|---------------------------|-------------|-------------------------|
| • Processor | - | Intel Core i3 Processor |
| • Hard Disk | - | 500 GB |
| • RAM | - | 4 GB |
| • Mouse | - | Optical |
| • Microcontroller | - | Arduino UNO |
| • Object Detection Sensor | - IR Sensor | |
| • Light Detection Sensor | - | LDR Sensor |

2.2 SOFTWARE REQUIREMENTS:

- Object system - Windows 10
- IDE – Arduino

III. PROJECT DESCRIPTION

3.1 BLOCK DIAGRAM:

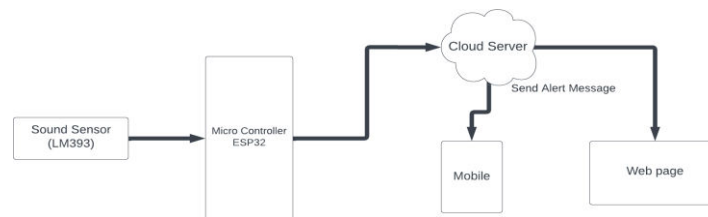

Figure 3.1-Block diagram

3.2 BLOCK EXPLANATION:

3.2.1 ESP32:

The ESP32 is a flexible and potent microcontroller and Wi-Fi/Bluetooth module. Its wireless connection capabilities and dual-core processor, which offer significant processing capacity, make it appropriate for a variety of Internet of Things (IoT) applications. The ESP32's low power consumption makes it perfect for battery-powered devices, and its integrated Wi-Fi and Bluetooth capabilities allow for smooth connectivity. A wide range of peripherals, GPIO ports, and development tools are also available for the ESP32, which is why many developers use it to prototype and create embedded systems with wireless connection.

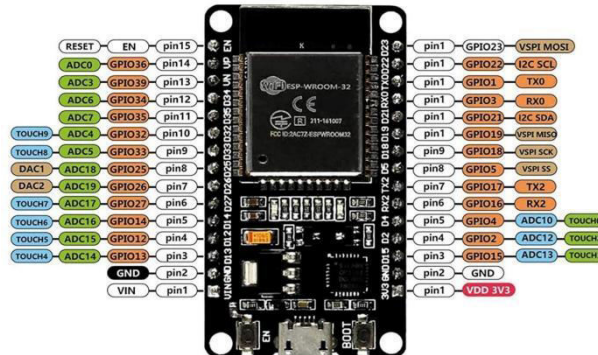

Figure 3.2.1- ESP32 BOARD

3.2.2 BOARD ARCHITECTURE:

A low-cost, low-power system-on-a-chip (SoC) microcontroller with built-in Bluetooth and Wi-Fi capabilities is called the ESP32. The Shanghai, China-based semiconductor business Espressif Systems is the one developing it. The adaptability and networking characteristics of the ESP32 make it a popular choice for Internet of Things applications.

3.2.3 CPU ARCHITECTURE:

Dual-core Xtensa LX6 microprocessors, which are 32-bit RISC processors. Clock frequency can go up to 240 MHz. The dual-core design allows for better multitasking and performance.

3.2.4 MEMORY:

The ESP32 typically comes with 520 KB of SRAM. Flash memory for program storage, ranging from 1 MB to 16 MB or more. External SPI RAM can be added for additional storage.

3.3 LM393 SENSORS:

Dual voltage comparator integrated circuits, or ICs, like the LM393, are frequently found in sensor and electrical circuit applications. It is composed of two separate open-collector precision voltage comparators. When comparing analog voltages and producing digital signals based on the comparison's outcome, the LM393 is frequently used. It can be used in sensor applications to transform analog signals from sensors—like temperature or light sensors—into digital signals that microcontrollers and other digital devices can process with ease. The LM393 is a widely used option for signal conditioning and comparison in a variety of electronic projects due to its affordability, adaptability, and simplicity of usage. A popular integrated circuit for dual voltage comparators in electronic circuits and sensors is the LM393.

3.3.1 LM393 PIN DESCRIPTION:

1. VCC (or VDD):

This pin is used to provide power to the sound sensor. It is usually connected to the positive voltage supply, typically 5V.

2. GND (or G):

This pin is the ground or common reference point for the circuit. It is connected to the ground of the power supply.

3. AO (Analog Output):

The Analog Output pin provides an analog voltage signal that varies based on the intensity or amplitude of the sound detected by the sensor. You can connect this pin to an analog input on a microcontroller or another device to read the analog signal.

4. D0 (Digital Output):

The Digital Output pin provides a digital signal (either high or low) based on a predefined sound threshold. This pin is often used to interface with digital input pins on a microcontroller. When the sound level exceeds the set threshold, the digital output goes high.

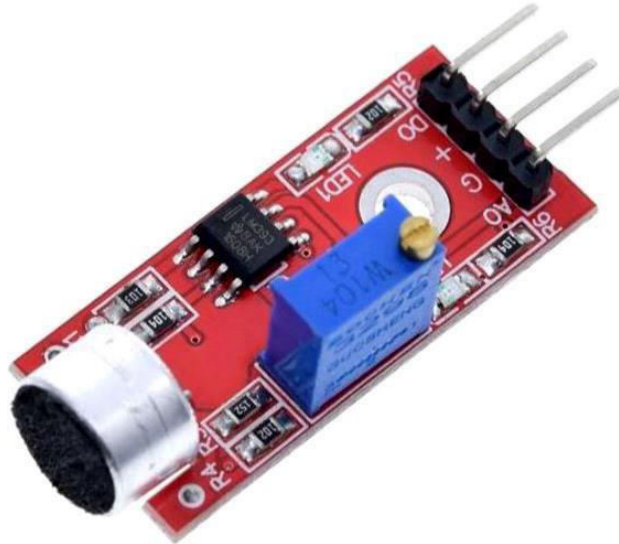

Figure 3.3 - LM393 Sensor

3.4 CIRCUIT DIAGRAM:

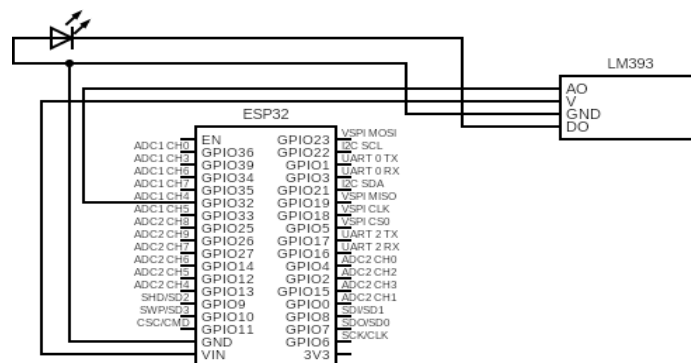

Figure 3.4-Circuit Diagram

IV. IMPLEMENTATION AND RESULT ANALYSIS

4.1 STEPS TO CONNECT:

Components Needed:

- ESP32 development board
- Sound sensor (4-pin configuration)
- Jumper wires

Identify Pins:

Identify the pins on your sound sensor, which typically include VCC, GND, AO (Analog Output), and DO (Digital Output).

Data Connections:

- If you want to use the Analog Output (AO), connect it to one of the analog pins on the ESP32 (e.g., A0).
- If you want to use the Digital Output (DO), connect it to one of the digital pins on the ESP32 (e.g., D2).

Upload and Run:

- Write a simple program using the Arduino IDE or another preferred development environment.
- Use the appropriate analog or digital pin in your code to read the sensor's output.
- You may set a threshold for the sound level if you're using the digital output, triggering an action when the sound exceeds the threshold.

Programming:

- Upload your program to the ESP32 and monitor the serial output to see the sensor's readings or digital output changes.
- Remember to check the datasheet or documentation for your specific sound sensor model to ensure correct pin connections and understand any additional features or settings. Also, keep in mind that the specific pin numbers on the ESP32 might vary based on the development board you are using.

V. RESULT ANALYSIS

In integrating a sound sensor with an ESP32 microcontroller, the device effectively captures and processes audio data for a diverse range of applications. The sound sensor's analog output is connected to one of the ESP32's analog input pins, enabling the microcontroller to receive real-time data reflecting variations in sound intensity. By employing appropriate threshold settings on the digital output pin, the ESP32 can rapidly respond to predefined sound levels, triggering specific actions or events in connected applications. This integration proves valuable in scenarios such as noise monitoring, security systems, or interactive projects where the ESP32's processing capabilities, coupled with the sound sensor's sensitivity, enable a nuanced and responsive interaction with the surrounding acoustic environment. The combination facilitates the development of intelligent and context-aware systems.

RESULT:

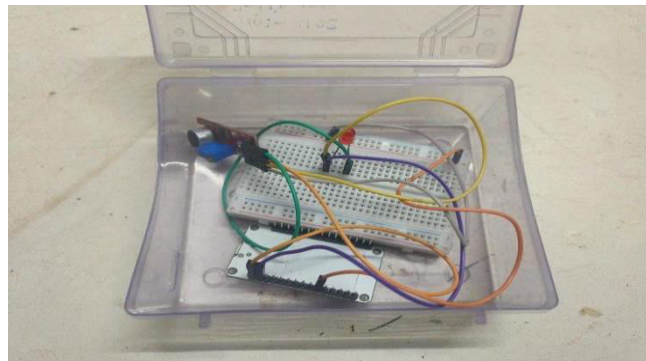

Figure 5.1 – SENSOR CONNECTION



Figure 5.2 – SOUND BOX

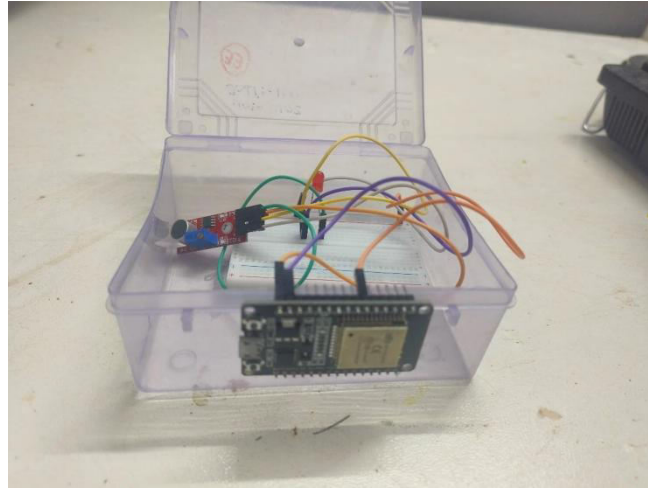

Figure 5.3 –CONNECTION OF SOUND SENSOR

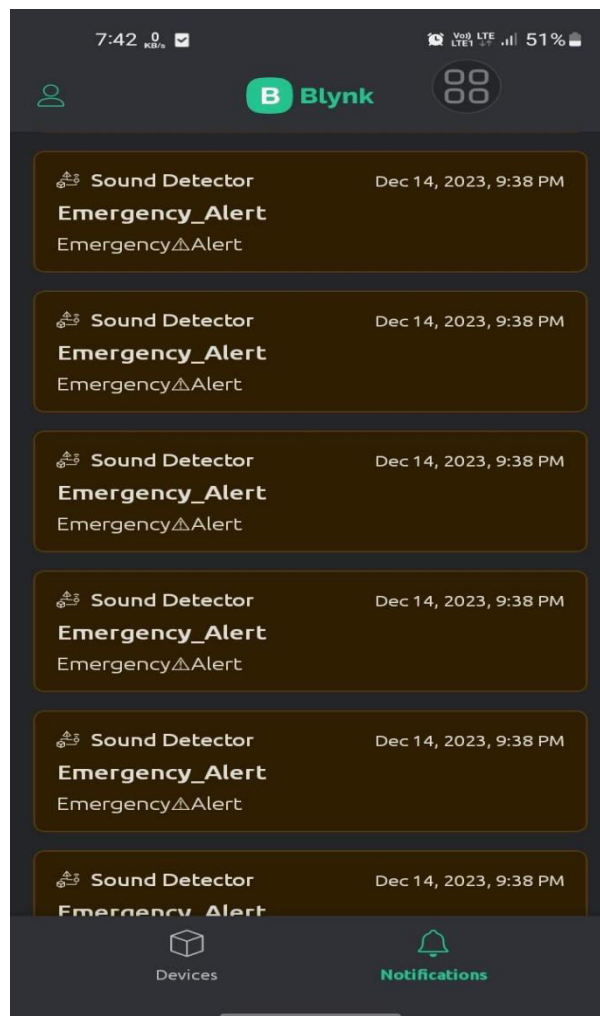

Figure 5.4 – NOTIFICATION IN APP

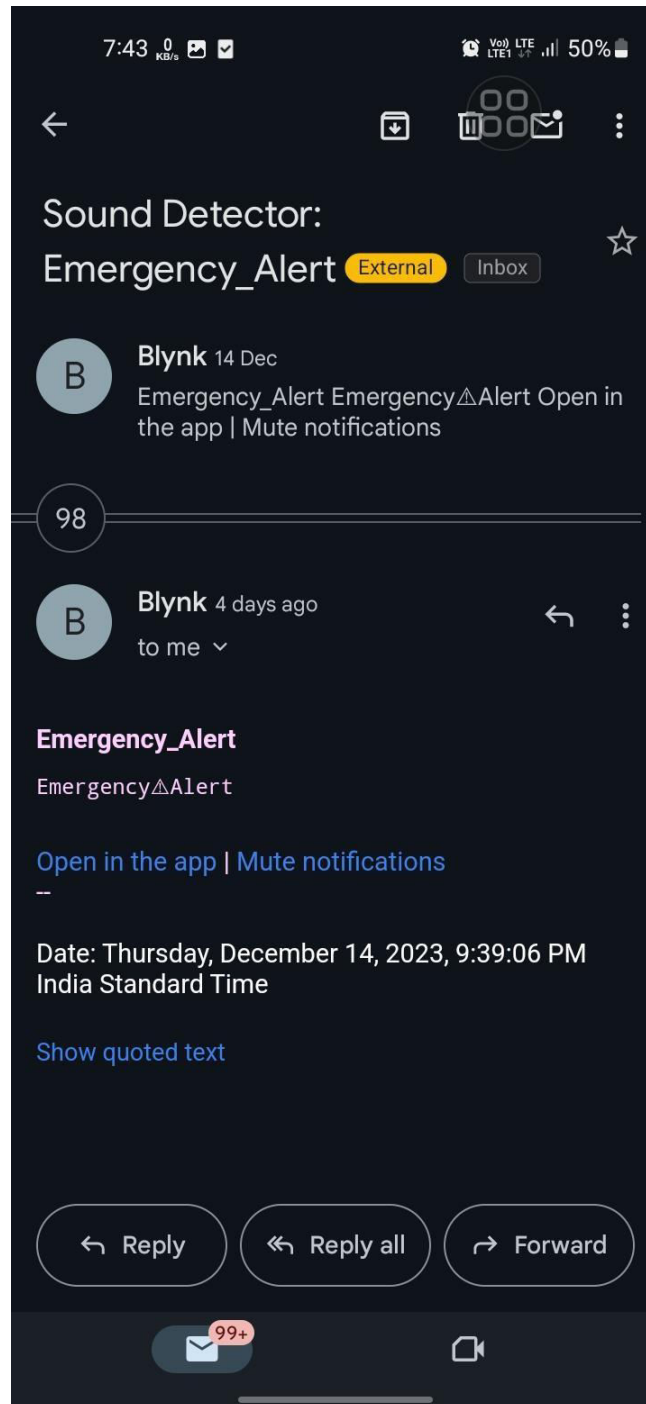

Figure 5.5 – NOTIFICATION IN CONNECTED GMAIL

VI. CONCLUSION

In conclusion, the integration of an ESP32 microcontroller with a sound sensor for an emergency alert system demonstrates a robust and versatile solution. The ESP32's capabilities, coupled with the sound sensor's ability to detect acoustic anomalies, create a responsive system capable of recognizing emergency signals in real-time. By leveraging the ESP32's connectivity features, such as Wi-Fi and Bluetooth, the emergency alert system can swiftly transmit critical

information to designated recipients or central monitoring systems. This amalgamation not only enhances the speed and efficiency of emergency response but also allows for remote monitoring and control. The system's adaptability makes it suitable for a wide array of scenarios, ranging from home security applications to public safety initiatives, providing a reliable and intelligent platform for timely emergency notifications.

6.1. FUTURE ENHANCEMENT:

For future enhancements to the emergency alert system utilizing ESP32 and a sound sensor, a robust integration of machine learning algorithms could be explored. This could enable the system to distinguish between various emergency sounds, such as sirens, alarms, or distress signals, enhancing the system's accuracy in recognizing critical situations. Additionally, incorporating geolocation data could enable more targeted alerts, providing relevant emergency information to specific geographic areas. Integration with cloud services for real-time data analysis and storage could enhance scalability and facilitate remote monitoring. Furthermore, implementing a multi-modal approach, combining data from other sensors like motion or environmental sensors, could contribute to a more comprehensive and reliable emergency detection system.

REFERENCES

1. Zhou, H. *The Internet of Things in the Cloud: A Middleware Perspective*, 1st ed.; CRC Press: Boca Raton, FL, USA, 2008.
2. Internet History of 1960s. Available online: <https://www.computerhistory.org/internethistory/1960s/> (accessed on 14 January 2019).
3. History of the Internet. Available online: http://en.wikipedia.org/wiki/History_of_the_Internet (accessed on 14 January 2019)
4. Ghasempour, "Internet of Things in Smart Grid: Architecture, Applications, Services, Key Technologies, and Challenges," *Inventions journal*, vol. 4, no. 1, pp. 1-12, 2019.
5. Ghasempour, "Optimum number of aggregators based on power consumption, cost, and network lifetime in advanced metering infrastructure architecture for Smart Grid Internet of Things," *IEEE Ann. Consum. Commun. & Netw. Conf.*, LasVegas, 2016, pp. 295-6
6. Ghasempour and T. K. Moon, "Optimizing the Number of Collectors in Machine-to- Machine Advanced Metering Infrastructure Architecture for Internet of Things-Based Smart Grid," *IEEE Green Technol. Conf.*, Kansas City, 2016, pp. 51-5. 4
7. M. A. Khan, K. Salah, "IoT security: Review, blockchain solutions, and open challenges," *Future Generation Computer Systems*, 2018, 82: 395-411.
8. Musa, A., "Wireless Laptop Alarm System," PhD thesis, University Malaysia Pahang, 2007
9. A. M. Zungeru, J. G. Kolo, and I. Olumide, "A Simple and Reliable Touch sensitive security System," arXiv preprint arXiv:1210.5973 (2012).
10. H. AHN and J. LEE, "Developing a Voice-directed Fire Alarm System Using Arduino Microcontroller," *jobari*, vol. 26, no. 2, pp. 1-12, May 2020.
11. H. S. Humaid et al, "Accident Notification System by using Two Modems GS and GPS," *International Journal of Applied Information Systems*, 2015.
12. J. Baramy et al, "Accident detection alerting system," *International Journal of Technical Research and Applications*, 2016.
13. H. Priya et al, "Security System using Arduino Microcontroller," *"International Advanced Research Journal in Science, Engineering and Technology (IARJSET)"*, 2017, 4.3: 107-110.
14. M. Karami, G. Viola McMorrow and L. Wang, "Continuous monitoring of indoor environmental quality using an Arduino based data acquisition system," *Journal of Building Engineering*, 2018, 19: 412-419.
15. J. Hasan, N. Salih, N. Abdulkhaleq and M. Mnati., "An Android smart application for an Arduino based local meteorological data recording," In: *IOP Conference Series: Materials Science and Engineering IOP Publishing*, 2019. p. 042014.



INTERNATIONAL
STANDARD
SERIAL
NUMBER
INDIA



INTERNATIONAL JOURNAL OF INNOVATIVE RESEARCH

IN SCIENCE | ENGINEERING | TECHNOLOGY

 9940 572 462  6381 907 438  ijirset@gmail.com



www.ijirset.com

Scan to save the contact details