



e-ISSN: 2319-8753 | p-ISSN: 2347-6710

IJIRSET

International Journal of Innovative Research in
SCIENCE | ENGINEERING | TECHNOLOGY



INTERNATIONAL JOURNAL OF INNOVATIVE RESEARCH

IN SCIENCE | ENGINEERING | TECHNOLOGY

Volume 13, Issue 6, June 2024

ISSN INTERNATIONAL
STANDARD
SERIAL
NUMBER
INDIA

Impact Factor: 8.423

 9940 572 462

 6381 907 438

 ijirset@gmail.com

 www.ijirset.com

Load Based Speed Limit System

Akash S, Dr. Princess Maria John Ph.D.

Student, Department of Master of Computer Applications, Hindusthan College of Engineering and Technology,
Coimbatore, India

Assistant Professor, Department of Master of Computer Applications, Hindusthan College of Engineering and
Technology, Coimbatore, India

ABSTRACT: An innovative device called a "Load Based Speed Limit System" is intended to control a vehicle's speed based on the weight or load it is carrying at any one time. In the context of commercial vehicles, where maximizing performance and safety is crucial, this technology is especially pertinent. The basic idea is to establish a speed limit that, in response to the vehicle's current load conditions, dynamically adjusts to ensure safe and effective functioning. Creating complex software logic would probably part of your job as an embedded software engineer with a focus on C programming during the system's development. This logic would be in charge of gathering information from the load sensors, analyzing it wisely, and finally coordinating the appropriate changes to the car's speed. Furthermore, your knowledge would be crucial for interacting with different hardware parts, which would allow the Load Based Speed Limit System to be smoothly integrated into the entire car architecture. Please feel free to submit further information if you have any specific questions or if there are any points of the "Load Based Speed Limit System" that you'd like more in-depth explanations on.

I. INTRODUCTION

To improve traffic efficiency and safety, create an Internet of Things (IoT) system that can dynamically modify speed restrictions in response to load and traffic circumstances. Insufficient road safety measures result from conventional speed limit systems' frequent inability to adjust to changing loads and traffic situations. Arduino Uno: A control and data analysis central processing unit. Load sensors: Use weight measurements to ascertain a vehicle's load. GPS Module: Offers location data in real-time for relevant modifications to the speed restriction. IoT connectivity: Permits connection between a centralized system and automobiles. To dynamically determine a vehicle's weight in real time, use load sensors. Use algorithms to establish the relationship between load data and suitable speed restrictions. Provide a system that allows speed limits to be dynamically changed in response to traffic circumstances and load assessments. To maximize traffic flow and road safety, make sure you respond in real time. Arduino Uno: A control and data analysis central processing unit. Load sensors: Use weight measurements to ascertain a vehicle's load.

GPS Module: Offers location data in real-time for relevant modifications to the speed restriction. IoT connectivity: Permits connection between a centralized system and automobiles. To dynamically determine a vehicle's weight in real time, use load sensors. Use algorithms to establish the relationship between load data and suitable speed restrictions. Provide a system that allows speed limits to be dynamically changed in response to traffic circumstances and load assessments. To maximize traffic flow and road safety, make sure you respond in real time. Make it possible for cars to communicate with a central server to share data. Establish an IoT architecture that is dependable and secure to enable seamless connectivity. Utilize GPS data integration to map the network of roads and modify speed limits according to certain geographic regions. Improve accuracy by taking into account elements like turns, crosswalks, and distances to residential or educational institutions. To process information from different cars and find the best speed restrictions, use data analytics. Analyze load levels and traffic patterns on a continual basis to increase system accuracy. Provide a user interface that allows drivers to access real-time updates on modified speed restrictions. Focus on clear and intuitive displays to ensure drivers are aware of the current limits and the reasons for adjustments. Enhance road safety by tailoring speed limits to actual load conditions. Optimize traffic flow by preventing unnecessary speed reductions on lightly loaded roads. Contribute to a more sustainable and efficient transportation system.

HOW IT WORKS

The workings of the "Auto Speed Control System" are revealed by means of a methodical fusion of Bluetooth connectivity, Arduino microcontroller functionality, and RFID technology, all of which are coordinated to produce an agile and clever structure for dynamic vehicle speed management. RFID Technology: The use of RFID technology is the system's core component.

RFID cards serve as special identification for discrete geographical areas. Every RFID card has a designated zone, and the moment an RFID reader picks one up, a series of events are set off. This starts the process of identifying the relevant zone, which is the initial stage of the contextual awareness of the vehicle's location in real time Processing by Arduino Microcontroller: The Arduino microcontroller, a flexible and programmable device, is the brains behind the system. It processes the data it receives from the RFID reader. After deciphering the RFID card's data, the Arduino determines the zone that is assigned to it and starts the relevant response. This entails figuring out the predetermined speed restriction linked to the identified zone and getting ready to relay this information to the control system of the car.

LCD Screen: The system has an LCD display to improve the user interface and offer real-time feedback. By means of communication between the Arduino and the LCD, the recognized zone can be visibly presented, facilitating prompt verification and monitoring. The system's decision-making process is made more transparent thanks to this visual representation, which also increases user control and comprehension .Bluetooth Communication: The Auto Speed Control System's incorporation of Bluetooth technology is a key component. The vehicle's speed can be dynamically adjusted thanks to this wireless connection module in response to demands made in real time. The speed control system of the car connects to the Arduino, which has Bluetooth functionality. The system can easily communicate changes to the speed restriction over this link, enabling quick and adaptable response to shifting circumstances. Mechanism of Speed Control: Interfacing with the vehicle's speed control mechanism is the last step in the operational sequence. The system notifies the driver of the vehicle of the designated speed restriction based on the data processed by the Arduino. The vehicle's speed is actually adjusted as a result of this interaction, bringing it into compliance with the specified boundaries linked .

II. CIRCUIT DIAGRAM

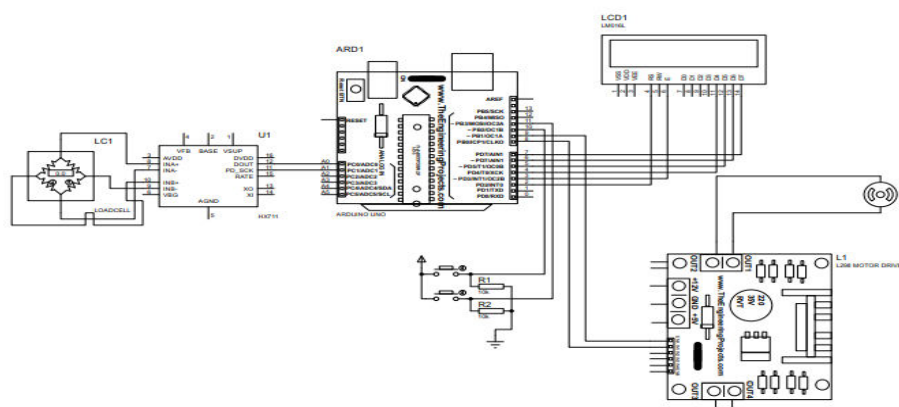

Figure 1: System Circuit Diagram

III. HARDWARE DESCRIPTION

A. Arduino UNO

The Arduino Uno is a popular microcontroller board designed for electronics prototyping and experimentation. It's part of the Arduino family of boards, which are widely used in various projects, from simple blinking LED experiments to complex robotics and automation systems.

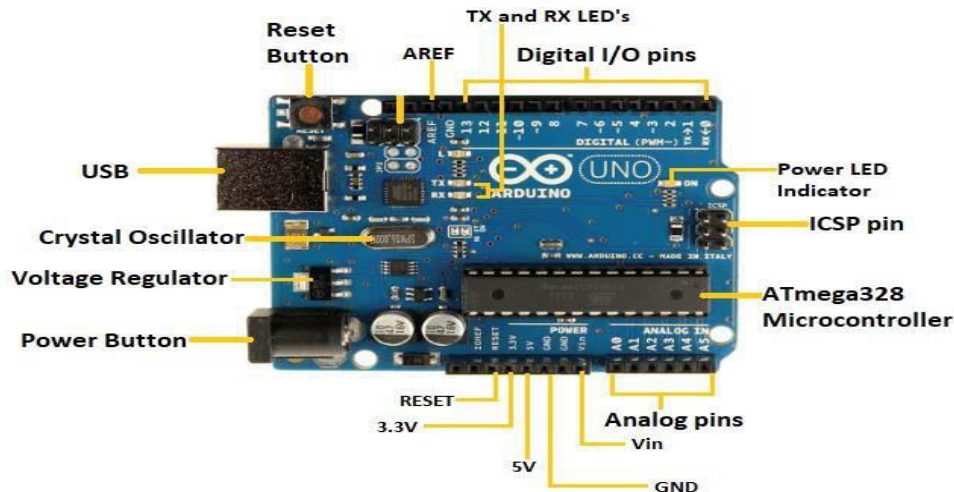

Figure 2: Arduino UNO

Each and every Arduino board requires a means of connecting to a power supply. You may power the Arduino UNO using a wall power source (like this one) or a USB connection that terminates in a barrel connector on your computer. The barrel jack is indicated (2) in the image above, while the USB connection is labeled (1). You can also load code onto your Arduino board using the USB connection. See our Installing and Programming Arduino tutorial for more details on how to program with Arduino. Pins: GND, 3.3V, 5V, AREF, Analog, Digital, PWM, and Analog

- The Arduino pins are where you attach wires to build a circuit (usually with the help of a breadboard and some wire). Typically, they feature "headers" made of black plastic that let you simply insert a wire into the board. There are various types of pins on the Arduino; each type is identified on the board and has a distinct purpose.
- GND (3): An acronym for "ground." The Arduino has multiple GND pins that you can utilize to ground your circuit.
- 3.3V (5) & 5V (4): The 5V pin provides 5 volts of electricity, as one might expect, and the 3.3V pin provides 3.3 volts.
- The majority of the basic parts that are used with the Arduino gladly operate on 3.3 or 5 volts.
- Analog (6): Analog In pins are those found in the region designated by the label "Analog In" on the UNO (A0 through A5). These pins have the ability to read an analog sensor signal (such as a temperature sensor) and translate it into a readable digital value.
- Digital (7): The digital pins (0 to 13 on the UNO) are located across from the analog pins. Digital output, such as illuminating an LED, and digital input, such as determining whether a button is pressed, are both possible with these pins.
- PWM (8): Some of the digital pins (3, 5, 6, 9, 10, and 11 on the UNO) may have had the tilde (~) next to them. In addition to functioning as regular digital pins, these pins can be utilized for pulse-width modulation, or PWM. For the time being, consider these pins as having the ability to replicate analog output (e.g., fading an LED in and out). We have a tutorial on PWM.

Reset Button

The reset button (10) on the Arduino is identical to that of the original Nintendo. By pushing it, you can restart any running code on the Arduino and momentarily link the reset pin to ground. If you want to test your code more than once but it doesn't repeat, this can be quite helpful. But unlike the original Nintendo, most issues are rarely resolved by

blowing on the Arduino. Power LED Indicator On your circuit board, there's a small LED next to the word "ON" just below and to the right of the word "UNO" (11). Every time you plug your Arduino into a power source, this LED ought to turn on. It's likely that there's a problem if this light doesn't turn on. It's time to examine your circuit again.

TX RX LEDs

TX is short for transmit, RX is short for receive. These markings appear quite a bit in electronics to indicate the pins responsible for serial communication. In our case, there are two places on the Arduino UNO where TX and RX appear -- once by digital pins 0 and 1, and a second time next to the TX and RX indicator LEDs (12). These LEDs will give us some nice visual indications whenever our Arduino is receiving or transmitting data (like when we're loading a new program onto the board).

Main IC

Integrated circuits, or ICs, are the black objects with all the metal legs (13). Consider it to be our Arduino's brains. The primary integrated circuit (IC) of an Arduino board varies slightly depending on the type of board, although it typically comes from ATMEL's AT mega line of ICs. This can be crucial since, before running a new program from the Arduino software, you might need to know the IC type in addition to your board type. Usually, this information is written in writing on the IC's top side. Reading the datasheets is frequently a smart option if you want to learn more about the differences between different integrated circuits.

Voltage Regulator

The voltage regulator (14) is not actually something you can (or should) interact with on the Arduino. But it is potentially useful to know that it is there and what it's for. The voltage regulator does exactly what it says -- it controls the amount of voltage that is let into the Arduino board. Think of it as a kind of gatekeeper; it will turn away an extra voltage that might harm the circuit. Of course, it has its limits, so don't hook up your Arduino to anything greater than 20 volts.

The Arduino Family

Arduino produces a variety of boards, each with unique features. Furthermore, as Arduino boards are open source hardware, others are free to alter and create variations of them with even more form factors and functionality. For some helpful tips, see this guide if you're unsure which one is best for your project. These are some choices that are ideal for someone who is just starting out with Arduino.

B. LOAD CELL

A load cell is one type of transducer that converts a force or load into an electrical signal. In many industrial and scientific applications, it is widely used to measure force, weight, tension, compression, and other types of loads. Load cells are widely used in many industries, such as manufacturing, aerospace, automotive, agricultural, and more.

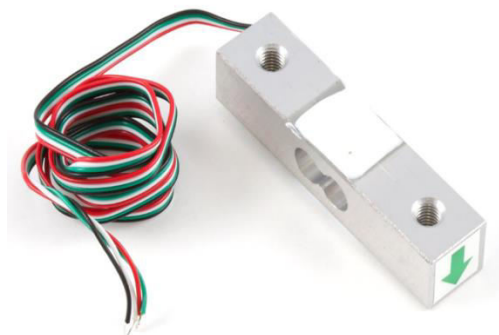

Figure 3: Load Cell

C.HX711

A precision 24-bit analog-to-digital converter (ADC) intended for industrial control applications and weight scales is the HX711. It is frequently utilized as an interface for load cells to measure force or weight. DIY electronics enthusiasts

and amateurs use the HX711 ADC in particular to create their own digital scales, load cell amplifiers, and related projects.

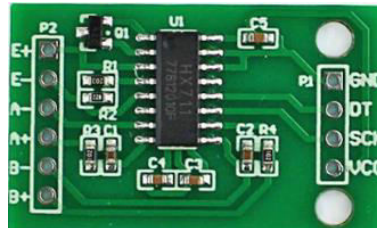

Figure 4: HX711

It's important to note that accurate measurement using the HX711 requires proper calibration to account for any variations in the load cell's behavior and environmental conditions. Calibration involves comparing the HX711's readings against known reference weights and adjusting calibration factors in the microcontroller's code to improve measurement accuracy.

Overall, the HX711 simplifies the process of interfacing with load cells and converting analog weight measurements into usable digital values for applications such as scales, industrial control systems, and more.

D. 16x2 Liquid Crystal Display LCD

One popular kind of alphanumeric display module that can show two lines of text with a maximum of 16 characters per line is a 16x2 LCD (Liquid Crystal Display). These screens are frequently used to show information to people in a variety of electronics projects, gadgets, and applications. The following information relates to a standard 16x2

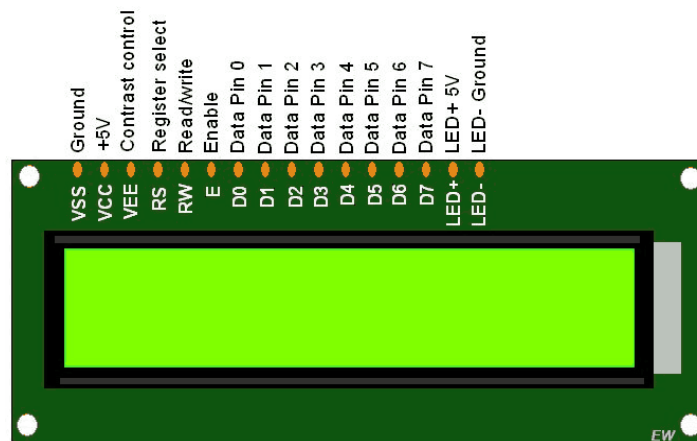

Figure 5: 16x2 Liquid Crystal Display LCD

D. Tactile Push Button

A tactile push button is a kind of switch that needs to be physically pressed, usually with a finger or another object, in order to become operational. When user input is necessary, these buttons are frequently seen in a variety of electronic equipment and control panels. They offer tactile feedback, which indicates that pressing the button will result in a tangible "click" or resistance, indicating that the button has been pressed. Typically, tactile push buttons have a button cover, an actuator or plunger, and a switch mechanism underneath.

When the button is pressed or released, an electrical connection is established or broken by the switch mechanism. A dome switch, a tiny metal dome that collapses and then rebounds when the button is pressed to produce the distinctive tactile sensation and audible click, is frequently used to provide tactile feedback.

**E.L298n Motor Driver:**

The L298 is a popular dual H-bridge motor driver integrated circuit (IC) that is commonly used to control DC motors and stepper motors. It's often used in robotics, automation projects, and various applications where motor control is required.

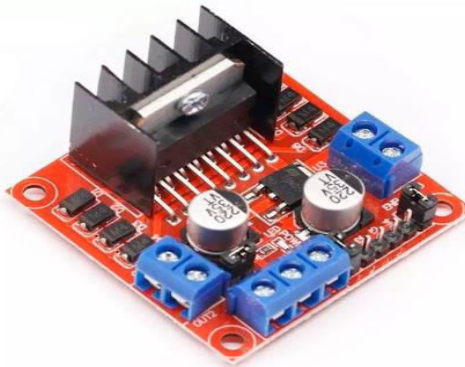

Figure 7: L298n Motor Driver

F. Gear Motors:

DC gear motors are electrical devices that convert electrical power from a 12-volt direct current (DC) source into mechanical motion. These motors are commonly used in a wide range of applications where low voltage operation and precise control of speed and torque are required. The addition of a gear mechanism allows these motors to deliver higher torque outputs at lower speeds.



Figure 8: Gear Motors

IV. IMPLEMENTATION AND RESULT ANALYSIS:

STEPS TO CONNECT

Connect ultrasonic With Arduino

- Connect the TRIG 2- out in ultrasonic to pin 7 in Arduino
- Connect the ECHO 3- out in ultrasonic to pin 6 in Arduino
- Connect the GND pin ultrasonic in to GND pin in Arduino
- Connect the VCC pin in ultrasonic to 5.5 V in Arduino
- Connect the LED to ARDUINO
- Connect the RED LED in pin 4 in Arduino
- Connect the YELLOW LED in pin 3 in Arduino
- Connect the GREEN LED in pin 2 in Arduino

The IoT-based U-turn vehicle accident prevention system aims to enhance road safety by addressing blind spots during U-turns. The system utilizes an Arduino Uno microcontroller, an HC-SR04 ultrasonic sensor, 1k Ω resistors, and red, green, and orange LEDs. In operation, the ultrasonic sensor measures the distance between the vehicle and potential obstacles, triggering a warning mechanism through the LEDs when a U-turn is detected within the predefined threshold. The red LED signals a potential danger, prompting the driver to exercise caution. Conversely, the green LED indicates a safe distance, allowing the driver to proceed without risk. This intelligent system acts as an additional layer of awareness, especially in scenarios where visual cues might be limited, ultimately contributing to the prevention of U-turn-related accidents.

V. RESULT

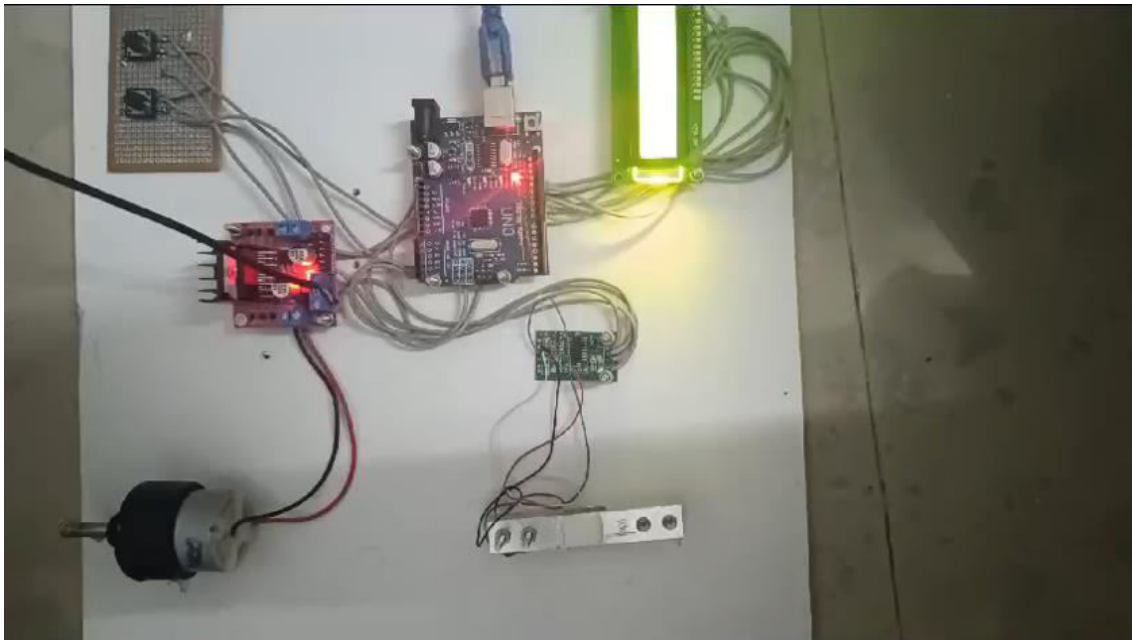

Figure 9: demonstrates the process load based speed limit system

VI. CONCLUSION

As the IoT-based load-based speed restriction system comes to an end, it is clear that integrating contemporary technology has great promise for improving traffic safety and maximizing vehicle performance. The experiment effectively illustrated how load sensors and Internet of Things connectivity may be used to dynamically modify speed limits according to the load conditions of the vehicle. With the use of an Arduino Uno, load sensors, and suitable

control mechanisms, the load-based speed limit system demonstrated its potential to encourage safer driving habits. The system enhances road safety by adjusting speed restrictions dynamically based on the load, hence improving control and stability.

The importance of this research resides in its capacity to tackle real-world issues, especially in areas like logistics and transportation. Load-sensitive speed limits lower the danger of accidents, wear and tear, and possible road damage by requiring vehicles to operate within safe bounds. It is imperative to recognize specific obstacles and opportunities for enhancement, nevertheless. It is imperative that load sensors be calibrated and fine-tuned, and that different road conditions be taken into account. Adherence to regulatory standards and interoperability with current traffic management systems are also essential for the broad implementation of these technologies. The load-based speed limit system offers a strong platform for upcoming developments. In order to achieve a more thorough approach to road safety, future research and development could investigate machine learning methods for more accurate load identification or take into account the integration of additional sensors. Furthermore, cooperation between regulatory agencies and automakers may make it easier to integrate these devices into more comprehensive traffic management plans.

REFERENCES

1. "Development of an Intelligent Speed Limit Warning System," W. M. S. Wijekoon, Y. S. Kim, et al., Published in: 2017 IEEE Intelligent Vehicles Symposium (IV).
2. "An Automatic Speed Limit Detection System," R. S. Balamurugan, V. S. Shanthi, et al., Published in: 2015 International Conference on Smart Technologies and Management for Computing, Communication, Controls, Energy and Materials (ICSTM).
3. "Intelligent Speed Adaptation Systems: A Review," M. Habibovic, J. Koorey, et al., Published in: 2017 20th International Conference on Intelligent Transportation Systems (ITSC).
4. "Design and Implementation of an Intelligent Speed Limit Control System," M. Y. Gokceoglu, S. Kaya, et al., Published in: 2018 International Artificial Intelligence and Data Processing Symposium (IDAP).
5. "Dynamic Speed Limit Control System for Urban Roads," Y. B. Kwon, D. M. Lee, et al., Published in: 2017 International Conference on Advanced Robotics and Intelligent Systems (ARIS).
6. "A Review on Intelligent Speed Adaptation System," H. Shams, M. Hadi, et al., Published in: 2017 International Conference on Computer, Control, Informatics and its Applications (IC3INA).
7. "Real-Time Speed Limit System for Intelligent Vehicles," A. P. Nandgaonkar, P. M. Patil, et al., Published in: 2015 International Conference on Pervasive Computing (ICPC).



INTERNATIONAL
STANDARD
SERIAL
NUMBER
INDIA



INTERNATIONAL JOURNAL OF INNOVATIVE RESEARCH

IN SCIENCE | ENGINEERING | TECHNOLOGY

 9940 572 462  6381 907 438  ijirset@gmail.com



www.ijirset.com

Scan to save the contact details