



e-ISSN: 2319-8753 | p-ISSN: 2347-6710

# IJRSET

International Journal of Innovative Research in  
**SCIENCE | ENGINEERING | TECHNOLOGY**

# INTERNATIONAL JOURNAL OF INNOVATIVE RESEARCH

IN SCIENCE | ENGINEERING | TECHNOLOGY

Volume 13, Special Issue 1, April 2024

**ISSN** INTERNATIONAL  
STANDARD  
SERIAL  
NUMBER  
INDIA

Impact Factor: 8.423

 9940 572 462

 6381 907 438

 [ijirset@gmail.com](mailto:ijirset@gmail.com)

 [www.ijirset.com](http://www.ijirset.com)

# Accident Detection and Messaging System Using MEMS and Arduino Nano

Mr. P. Manivannan<sup>1</sup>, R. Suman<sup>2</sup>, S.V. Uthay Kumar<sup>3</sup>, V. Vasanth Kumar<sup>4</sup>,

C. Yeshvanth Kumar<sup>5</sup>

Associate Professor, Department of Electronics and Communication Engineering, Adhiyamaan College of Engineering, Krishnagiri, Tamil Nadu, India<sup>1</sup>

U.G Scholars, Department of Electronics and Communication Engineering, Adhiyamaan College of Engineering, Krishnagiri, Tamil Nadu, India<sup>2, 3, 4, 5</sup>

**ABSTRACT:** Road safety is a critical concern, and timely response to vehicular accidents is crucial for minimizing the severity of injuries and fatalities. This project proposes an innovative Accident Detection and Messaging System (ADMS) designed to promptly detect accidents and communicate distress messages to predefined contacts using Microelectromechanical Systems (MEMS), Global System for Mobile Communications (GSM), Global Positioning System (GPS), and Arduino Nano technology. The core of the system relies on a MEMS accelerometer interfaced with a Arduino Nano, continuously monitoring vehicular acceleration. An intelligent algorithm processes real-time accelerometer data to identify patterns indicative of potential accidents. Upon detection, the system triggers a GPS module to obtain precise location coordinates, ensuring accurate reporting of the incident. The Integration of a GSM module enables the system to send SMS alerts containing critical information, including the accident location and a distress message, to predefined emergency contacts. Additionally, an optional feature can be implemented to initiate phone calls to emergency services or designated contacts, enhancing the responsiveness of the system. The Arduino Nano serves as the central processing unit, orchestrating seamless communication between the MEMS accelerometer, GPS module, and GSM module.

**KEYWORDS:** GPS, GSM, MEMS, Sensor, Arduino Nano.

## I. INTRODUCTION

With the increasing demand for timely emergency response systems, the development of Accident Detection and Messaging Systems (ADMS) has garnered significant attention. These systems aim to enhance emergency response efficiency by automating the detection and reporting of accidents. In this paper, we propose an innovative ADMS that integrates Microelectromechanical Systems (MEMS), Global System for Mobile Communications (GSM), Global Positioning System (GPS), and Arduino Nano. By harnessing MEMS sensors for accident detection, GSM for communication, GPS for accurate location tracking, and Arduino Nano for system coordination, our ADMS offers a comprehensive solution to expedite emergency response and improve outcomes for accident victims. This introduction provides an overview of the rationale behind the development of our system and previews the key components and functionalities that will be elaborated upon in subsequent sections.

## II. RELATED WORKS

Several related works have focused on developing Accident Detection and Messaging Systems using MEMS sensors and Arduino Nano microcontrollers, contributing to advancements in road safety and emergency response. Research studies have explored the use of MEMS accelerometers and gyroscopes to detect sudden changes in vehicle movement or orientation, which are indicative of accidents. These sensors, integrated with Arduino Nano, enable real-time

processing of sensor data and the triggering of emergency alerts.

Additionally, related works have investigated the integration of MEMS-based systems with other technologies such as GPS for accurate location tracking during emergencies. This combination ensures that emergency services can quickly locate and respond to accident scenes, potentially reducing response times and improving outcomes for accident victims. Moreover, research efforts have focused on optimizing power consumption and system efficiency in MEMS and Arduino Nano-based solutions to ensure reliable and long-lasting operation in vehicles.

Furthermore, several projects have explored the customization and adaptation of these systems for specific use cases, such as integrating them into wearable devices or developing portable emergency response kits. These adaptations showcase the versatility and scalability of MEMS and Arduino Nano-based solutions in addressing various road safety challenges. Overall, the related works in this field highlight the ongoing efforts to leverage MEMS sensors and Arduino Nano microcontrollers for creating effective and responsive Accident Detection and Messaging Systems, with the potential to significantly enhance road safety worldwide.

### III. EXISTING METHOD

Existing methods for accident detection and messaging systems encompass a range of technologies and approaches. One prevalent method involves integrating sensors like accelerometers and GPS into vehicles to detect abrupt changes in velocity or location, indicative of accidents. These systems are often coupled with automatic distress signal transmission to emergency services or designated contacts. Smartphone-based solutions utilize device sensors and connectivity to detect crashes and trigger emergency calls or alerts. Additionally, IoT devices and wearables contribute by monitoring vital signs and detecting falls, facilitating timely responses. Machine learning algorithms play a crucial role in improving detection accuracy by analyzing data patterns associated with different types of accidents, minimizing false alarms. Cloud-based solutions further enhance these systems by enabling real-time data processing and coordination among multiple stakeholders for efficient emergency response. These existing methods showcase a comprehensive and integrated approach to accident detection and messaging, leveraging diverse technologies to enhance safety on roads and in other settings.

### IV. PROPOSED SYSTEM

An accident detection and messaging system utilizing Microelectromechanical Systems (MEMS) sensors and an Arduino Nano microcontroller offers a cost-effective and efficient solution. MEMS sensors such as accelerometers and gyroscopes can detect sudden changes in acceleration, orientation, and vibration, which are indicative of accidents or collisions. These sensors can be interfaced with an Arduino Nano board, which serves as the central processing unit for data collection and analysis. The Arduino Nano can run algorithms to interpret sensor data and determine if an accident has occurred based on predefined thresholds or patterns. Once an accident is detected, the system can activate predefined actions such as sending emergency alerts via SMS, triggering alarms, or initiating automatic emergency calls. The compact size and low power consumption of MEMS sensors and Arduino Nano make this system suitable for integration into vehicles, wearable devices, or smart infrastructure for real-time accident detection and rapid response, ultimately contributing to improved safety on roads and in various environments.



V. BLOCK DIAGRAM

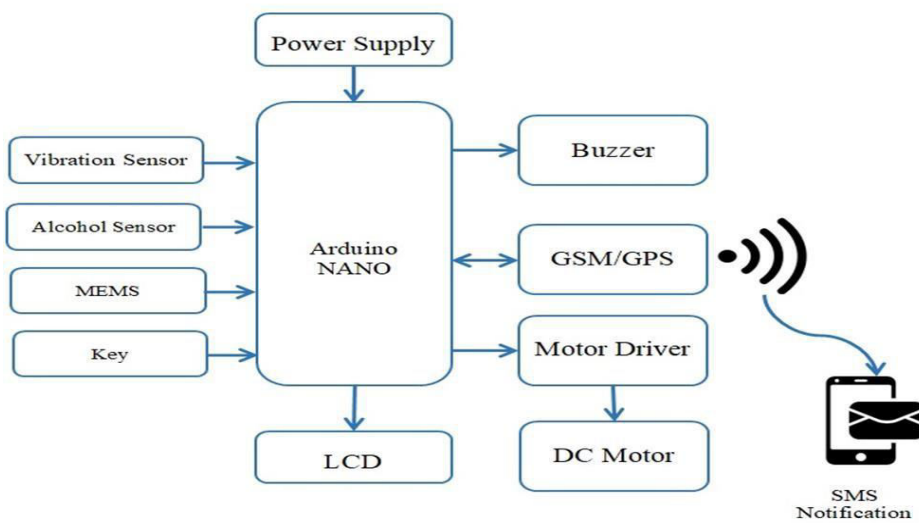

Fig 1. Flow diagram for proposed method

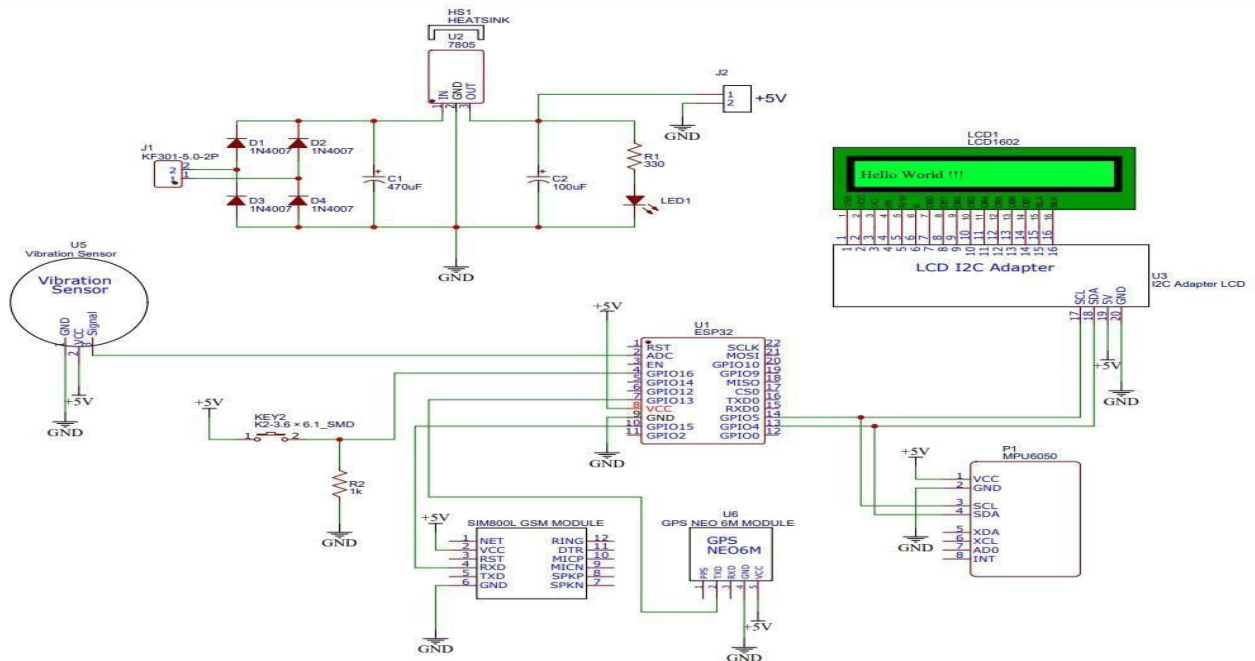

Fig 2. Circuit diagram

## VI. EXPERIMENTAL RESULTS

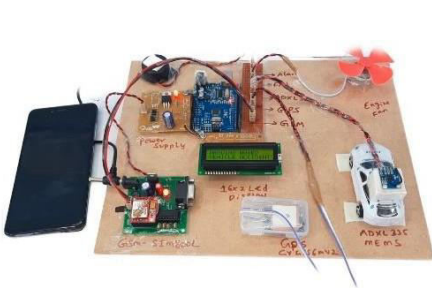

Fig no:3

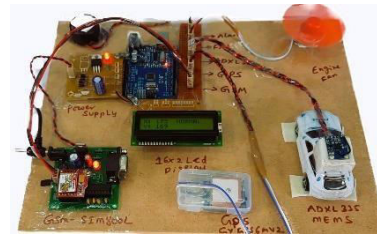

Fig no:4

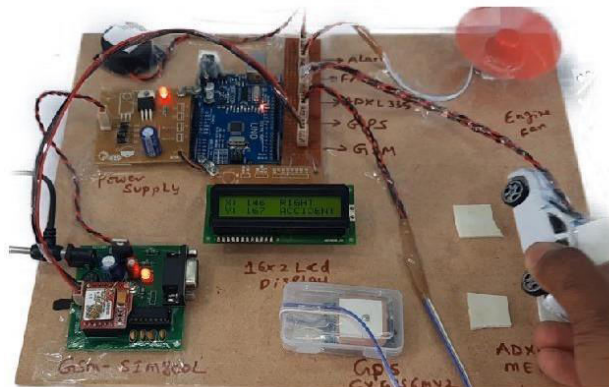

Fig no:5

- These system is developed to provide the information about the accident occur and the location of the accident.
- It helps to easily provide the assistant and help to the victim of the accident. This system uses GPS module to locate the vehicle
- GSM is used to provide the information of accident. The results of the proposed systems are satisfactory.
- The main is to aims to minimize response time, facilitate timely assistance to affected individuals, and improve overall situational awareness for better management of critical situations
- If the vehicle the faces less damages driver can restrict to send the message notification. If any more damages the message can send automatic.

## VII. FUTURE SCOPE

The future scope of an Accident Detection and Messaging System utilizing MEMS and Arduino Nano technology is incredibly promising. As technology continues to advance, these systems will likely become more sophisticated and integrated into various aspects of transportation and urban infrastructure. One major area of development is the enhancement of real-time accident detection capabilities using MEMS sensors, which are becoming increasingly precise and reliable. This will enable quicker response times from emergency services, potentially reducing the severity of accidents and

saving lives.

Over all, the future scope of Accident Detection and Messaging Systems using MEMS and Arduino Nano technology encompasses a wide range of possibilities, from enhanced safety features in vehicles to smarter urban infrastructure and improved emergency response mechanisms.



### VIII. CONCLUSION

The proposed system is developed to provide the information about the accident occur and the location of the accident. It helps emergency services to get there faster and help the victim of the accident. This system uses GPS module to locate the vehicle. GSM is used to provide the information of accident. It is a smart and effective way to protect lives and property.

### REFERENCES

- [1] H. D. Pham, M. Drieberg and C. C. Nguyen, "Development of vehicle tracking system using GPS and GSM modem," in IEEE Conference on Open Systems (ICOS), Kuching, 2013.
- [2] Mashood Mukhtar, "GPS based Advanced Vehicle Tracking and Vehicle Control System", I.J. Intelligent Systems and Applications, 2015, 03, 1-12
- [3] Albert Alexe, R. Ezhilarasie, "Cloud Computing Based Vehicle Tracking Information Systems", ISSN: 2229 - 4333 (Print)
- [4] | ISSN: 0976 - 8491 (Online) IJCST Vol. 2, Issue 1, March 2011
- [5] Ambade Shruti Dinkar and S.A Shaikh, Design and Implementation Of Vehicle Tracking System Using GPS, Journal of Information Engineering and Applications, ISSN 2224-5758, Vol 1, No.3, 2011.
- [6] M. Ahmad Fuad and M. Drieberg, "Remote vehicle tracking system using GSM Modem and Google map," in IEEE Conference on Sustainable Utilization and Development in Engineering and Technology (CSUDET), Selangor, 2015.
- [7] S. Stephen, "AUTOMATIC VEHICLE DETECTION USING GPS AND CHALLENGES IN IMAGE PROCESSING," vol. 8, no. 11, pp. 287-293, 2017
- [8] G. B. Raja, A. Keerthika, S. G. Keerthika, A. Nandhini, and K. J. Pranitha, "GSM based Vehicle Accident Alert System," vol. 9, no. 5, pp. 309-312, 2021.

### BIOGRAPHY

	Mr. P. Manivannan, Associate Professor, Electronics and Communication Engineering Department, Adhiyamaan college of Engineering, Hosur
	Suman R, Electronics and Communication Engineering Department, Adhiyamaan college of Engineering, Hosur
	Uthay Kumar S V, Electronics and Communication Engineering Department, Adhiyamaan college of Engineering, Hosur

**International Journal of Innovative Research in Science, Engineering and Technology**

An ISO 3297: 2007 Certified Organization



Volume 13, Special Issue 1, April 2024

11<sup>th</sup> National Conference on Frontiers in Communication & Signal Processing Systems (NCFCSPS '24)

25<sup>th</sup> - 26<sup>th</sup> April 2024

Organized by

Department of ECE, Adhiyamaan College of Engineering, Hosur, Tamilnadu, India

	Vasanth Kumar V, Electronics and Communication Engineering Department, Adhiyamaan college of Engineering, Hosur
	Yeshvanth Kumar C, Electronics and Communication Engineering Department, Adhiyamaan college of Engineering, Hosur





INTERNATIONAL  
STANDARD  
SERIAL  
NUMBER  
INDIA



# INTERNATIONAL JOURNAL OF INNOVATIVE RESEARCH

IN SCIENCE | ENGINEERING | TECHNOLOGY

 9940 572 462  6381 907 438  [ijirset@gmail.com](mailto:ijirset@gmail.com)



[www.ijirset.com](http://www.ijirset.com)

Scan to save the contact details