



International Journal of Innovative Research in Science Engineering and Technology (IJIRSET)

(A Monthly, Peer Reviewed, Refereed, Scholarly Indexed, Open Access Journal)



Impact Factor: 8.699

Volume 14, Issue 2, February 2025

Renewable Energy based Microgrid Energy Management System using MATLAB/ Simulink

Mrs. Suma C¹, Rakshithgowda T S², Chethan Gowda C U³, Ullas M Gowda⁴, Anjaneya P M⁵

Assistant Professor, Department of Electrical & Electronics Engineering, SJBIT, Bengaluru, Karnataka, India¹

U.G. Student, Department of Electrical & Electronics Engineering, SJBIT, Bengaluru, Karnataka, India^{2,3,4,5}

ABSTRACT: The increasing demand for sustainable living has led to the development of innovative energy management solutions. This capstone project, Renewable Energy-Based Microgrid Energy Management System, aims to reduce electricity costs and promote renewable energy adoption in residential applications. It integrates solar panels, wind turbines, and grid electricity to optimize energy usage and minimize costs. The project utilizes MATLAB/Simulink for simulation, analysing each energy source's performance individually and in combination. The results demonstrate significant cost savings and increased reliance on renewable energy. By modelling various scenarios, the study validates the economic and environmental feasibility of such a system. The findings showcase the effectiveness of intelligent energy management in reducing fossil fuel dependence and lowering carbon emissions. The project contributes to advancing energy-efficient technologies and practical implementation of sustainable energy solutions. It highlights the economic viability of residential microgrids, making sustainable living cost-effective. Ultimately, this study paves the way for widespread adoption of renewable energy in residential applications.

KEYWORDS: Renewable energy, microgrid, energy management, cost reduction, solar power, wind energy, MATLAB simulation, sustainability, residential energy, carbon footprint reduction.

I. INTRODUCTION

The growing global focus on sustainability has increased the demand for innovative energy management solutions that balance environmental and economic goals. Residential energy consumption is a key area for integrating energy-efficient and renewable solutions. This capstone project, Renewable Energy-Based Microgrid Energy Management System, aims to develop a cost-effective and environmentally conscious energy system for residential applications. It integrates solar PV panels, wind turbines, and grid electricity to optimize energy usage and reduce costs. MATLAB/Simulink is used to simulate and analyse system performance under varying conditions, considering factors like energy demand, weather, and grid availability. The results demonstrate significant cost savings and reduced reliance on fossil fuels, lowering carbon emissions. The integration of solar and wind energy within a residential microgrid highlights the feasibility of reducing dependence on conventional grid electricity. This project contributes to advancing energy management systems by showcasing the practical application of hybrid renewable energy solutions. It underscores the potential for widespread adoption of sustainable living practices through intelligent energy management. By minimizing costs and promoting renewable energy, the proposed microgrid system offers a viable solution for efficient residential energy management.

This paper is organized as follows. Section II describes the system design and component specifications, detailing the architecture of the renewable energy-based microgrid, including solar PV, wind energy, battery storage, and grid integration. It also outlines the specifications of major components used in the system. Section III presents the methodology, explaining the modelling and simulation approach in MATLAB/Simulink, along with the energy management strategy employed for optimal power distribution. Section IV discusses the results obtained from the simulation, analysing the system's performance in terms of energy efficiency, cost savings, and reliability. Finally, Section V presents the conclusion, summarizing key findings and potential future improvements in the proposed energy management system.

II. SYSTEM DESIGN AND COMPONENTS SPECIFICATION

2.1 Block diagram

The block diagram of the Renewable Energy-Based Microgrid Energy Management System illustrates the integration of key components to optimize renewable energy for residential loads. Solar panels convert sunlight into electricity, while wind turbines generate power from wind, both feeding into the energy management system. Conventional grid electricity serves as a backup to ensure a stable power supply. A battery system stores excess energy from renewables and releases it during low production periods, enhancing reliability. This integrated system ensures efficient energy utilization, cost savings, and sustainability.

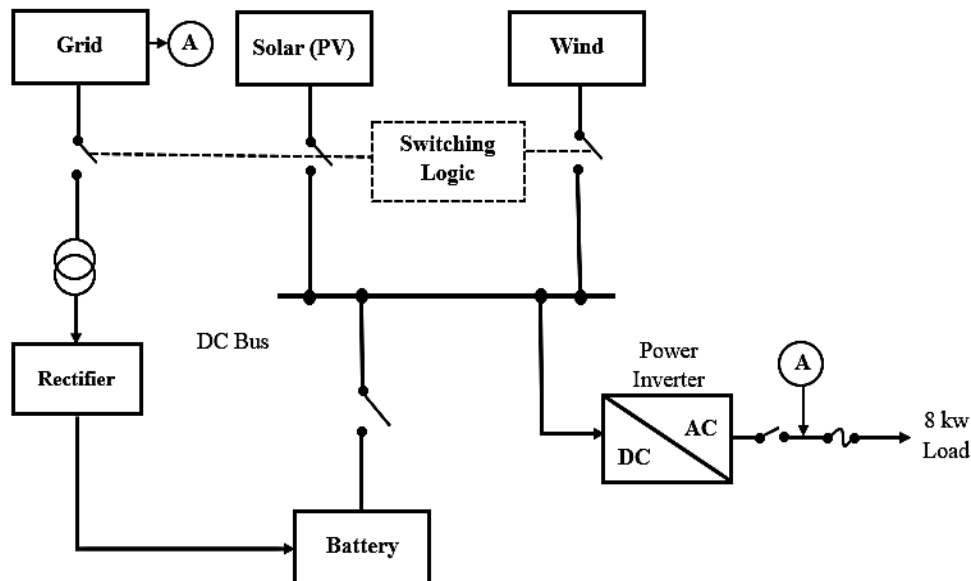

Figure 2.1 Block diagram

2.2 Component specification

2.2.1 Solar Panel Array

The solar panel array captures sunlight, converting it into direct current (DC) electrical energy. Positioned strategically, this array is a fundamental component for harnessing renewable solar energy and contributing to the overall power generation.

Array data

Parallel Strings = 2

Series-connected modules per strings = 20

- Total Load demand for Photo-Voltic panels are = 8 KW
- The maximum power of a single module is = 240.53 W.
- Number of modules connected in series = 20
- Power per string = $240.53 \times 20 = 4810.6$ W
- No. of strings = (Total load demand / Power per string)

$$\text{No. of strings} = \frac{8000}{4810.6} = 1.66$$

- Number of modules connected in parallel string = 2

$$\text{Total Power} = 2 \times 4810.6 = 9621.2 \text{ W}$$

2.2.2 Wind Turbine

The wind turbine array captures wind energy, converting it into electrical energy. Positioned strategically, this array complements the solar panel array, contributing renewable energy to the system, particularly during periods of wind activity.

The output power of a Wind turbine is given by:

$$P = \left(\frac{1}{2}\right) \rho * A * v^3 * C_p * \eta$$

Where:

- P is the output power of the wind turbine (in watts, W).
- ρ is the air density (kg/m^3)
- A is the swept area of the wind turbine blades
- v is the wind speed (in m/s)
- C_p is the power coefficient, which represents the efficiency of the turbine in converting wind energy into mechanical energy.
- η is the overall efficiency of the system.

In order to find the power generation from a wind turbine we have to calculate its swept area (A) of the blades. Swept area is the area of the circle created by the blades as they sweep through the air.

The Swept Area of a turbine is given by:

$$A = \pi r^2$$

$$R = 0.94 \text{ m}$$

$$A = 2.8 \text{ m}^2$$

The value of air density is 1.225 kg/m^3

$C_p = (0.3 - 0.5)$, so we are taking 0.4.

Efficiency = 0.85

Considered 25 m/s wind speed

$$P = \left(\frac{1}{2}\right) 1.225 * 2.8 * (25)^3 * 0.4 * 0.85$$

$$P = 10000 \text{ W (Nearly)}$$

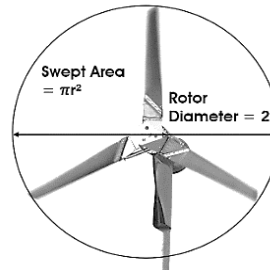

2.2.3 Inverter

The inverter, designed with Insulated Gate Bipolar Transistor (IGBT) technology, transforms stored DC energy from the battery into alternating current (AC). This conversion ensures compatibility with the electrical grid and the 3phase load, facilitating a seamless integration of renewable energy.

The output Power of the inverter is affected by its efficiency = η_{inv}

$$P_{out} = P_{in} * \eta_{inv}$$

$$P_{out} = 10000 * 0.85 = 8500 \text{ W}$$

The output current is given by:

$$I_{out} = P_{out} / V_{out}$$

$$I_{out} = 8000 / 415 = 19.27 \text{ A}$$

2.2.4 Battery

The battery serves as an energy storage device, storing excess direct current (DC) energy generated by the solar panel array. This stored energy acts as a buffer, ensuring a continuous power supply during periods of low renewable energy generation.

Nominal voltage (V) = 700

Rated capacity (Ah) = 100

Initial state-of-charge (%) = 50

Battery Modelling:

Energy Demand (Wh) = Total Power Demand (W) × Autonomy Period (h)

Total Power Demand = 8 KW

Autonomy Period (h) = 10 h

Energy Demand = $8000\text{W} \times 10\text{h} = 80000\text{Wh}$

Depth of Discharge (DoD):

$$\text{Usable Energy (Wh)} = \frac{\text{Energy Demand (Wh)}}{\text{Depth of Discharge (DoD)}}$$

$$\text{Usable Energy (Wh)} = \frac{80000\text{Wh}}{1.23}$$

$$\text{Usable Energy (Wh)} = 65000\text{Wh}$$

Battery Capacity:

$$\text{Battery Capacity (Ah)} = \frac{\text{Usable Energy}}{\text{Battery Voltage}}$$

$$\text{Battery Capacity (Ah)} = \frac{65000}{700}$$

$$\text{Battery Capacity (Ah)} = 100 \text{ Ah}$$

III. METHODOLOGY

The Renewable Energy-Based Microgrid Energy Management System is developed and simulated in MATLAB/Simulink to optimize energy distribution among solar, wind, battery storage, and grid sources. The system is modelled to ensure reliable power supply, maximize renewable energy utilization, and maintain system stability through intelligent control mechanisms. The simulation consists of photovoltaic (PV) panels, a wind turbine with a DC generator, an inverter, a battery storage system, and a grid connection. Each component is integrated with control algorithms, including a PID controller for voltage regulation and logic gates for intelligent switching between energy sources.

During daytime operation, the PV system is the primary energy source, supplying AC power via an inverter while simultaneously charging the battery. The nighttime operation prioritizes battery discharge to supply the load, with an automatic shift to wind energy or grid power when battery levels fall below a predefined threshold. The wind energy system incorporates a 20-second voltage ramp-up period, ensuring smooth startup before transitioning to load supply. A PID controller manages the switching between solar and wind power, optimizing energy utilization. When wind conditions are insufficient, the grid serves as a backup source.

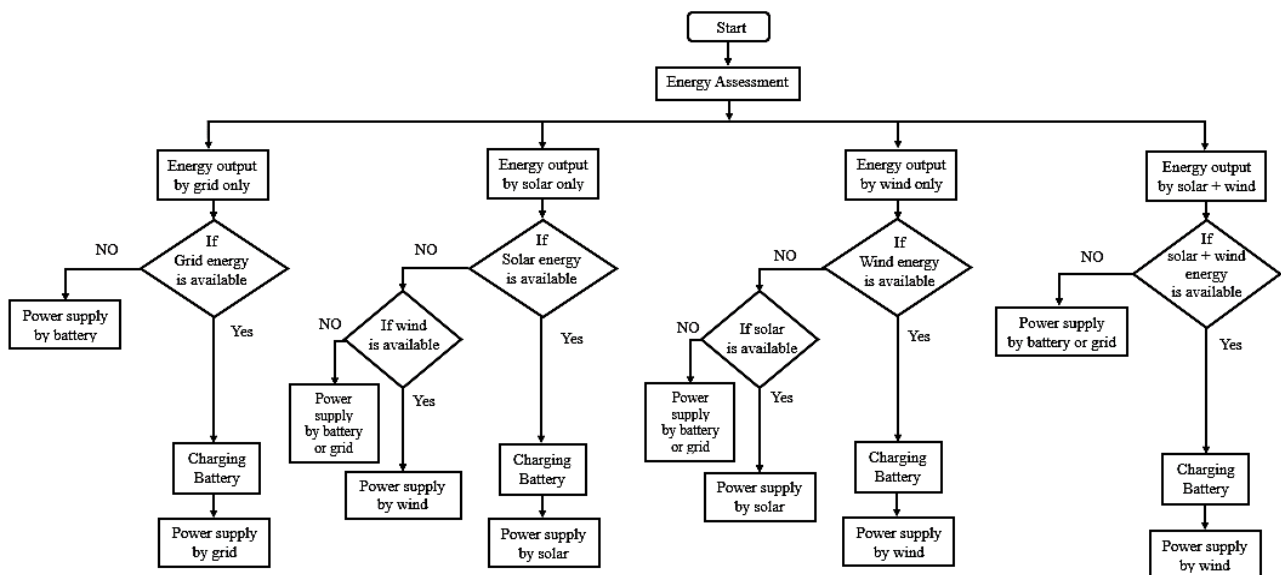

Figure 3.1 Flow chart of the system

A priority-based control algorithm is implemented to ensure optimal energy distribution when multiple sources are available. Solar power takes precedence, followed by wind energy, with the grid as the last resort. The Power GUI interface provides real-time monitoring of energy generation, consumption, and source transitions, enabling user interaction. The battery management system ensures controlled charging/discharging and incorporates a load-shifting mechanism to prevent excessive depletion. The inverter, designed with PWM-based IGBT control, efficiently converts DC to three-phase AC, ensuring compatibility with the load. The MATLAB/Simulink simulation integrates transmission losses to model realistic grid operations, allowing for a comprehensive analysis of energy efficiency and system reliability.

IV. RESULTS AND DISCUSSIONS

4.1 Different scenario of source

4.1.1 Scenario-1

Only Grid Power Source available: The grid is supplying power to meet the entire load demand as both solar and wind energy sources are unavailable. Simultaneously, the battery is charging using grid power to ensure energy storage for future use.

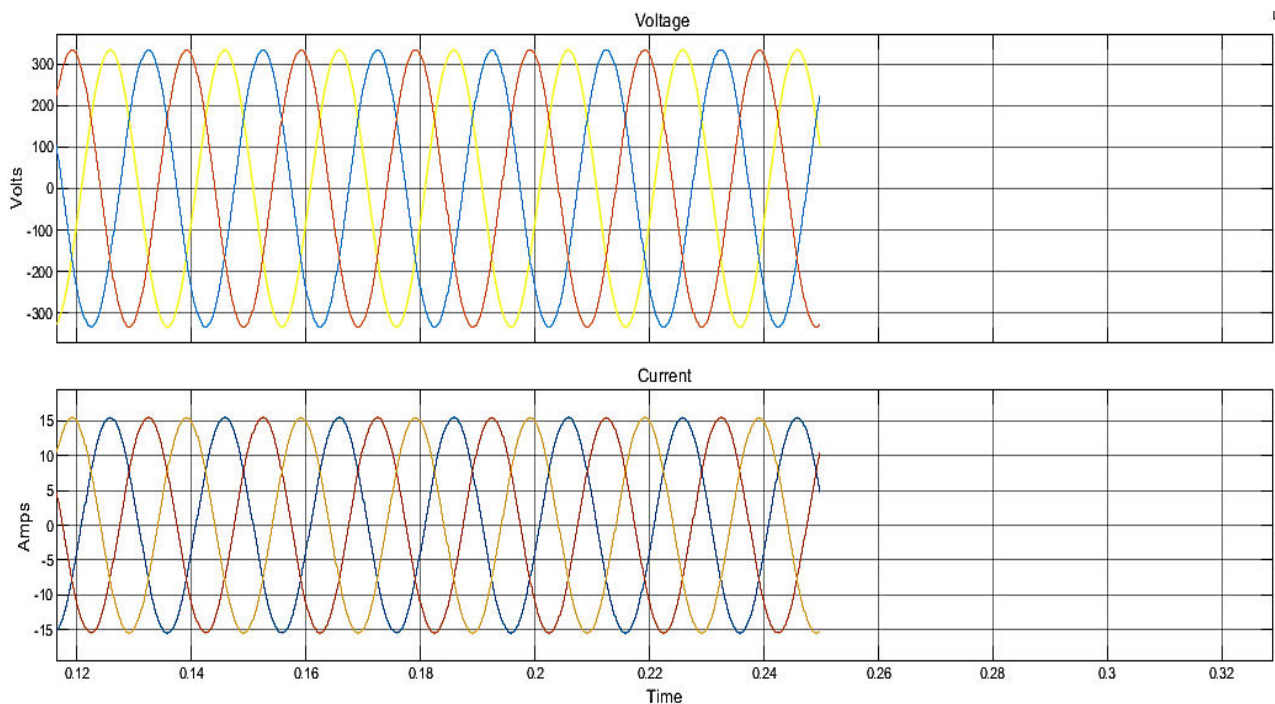

Figure 4.1 Output Voltage and Current of scenario – 1

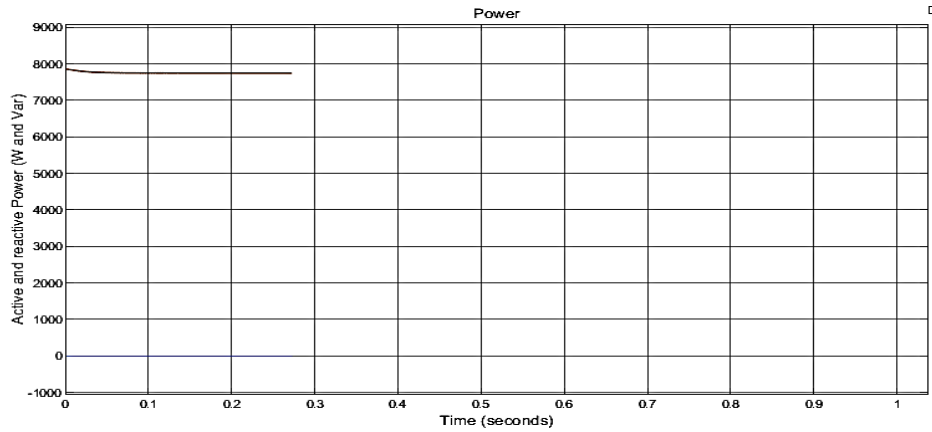

Figure 4.2 Output power of scenario – 1

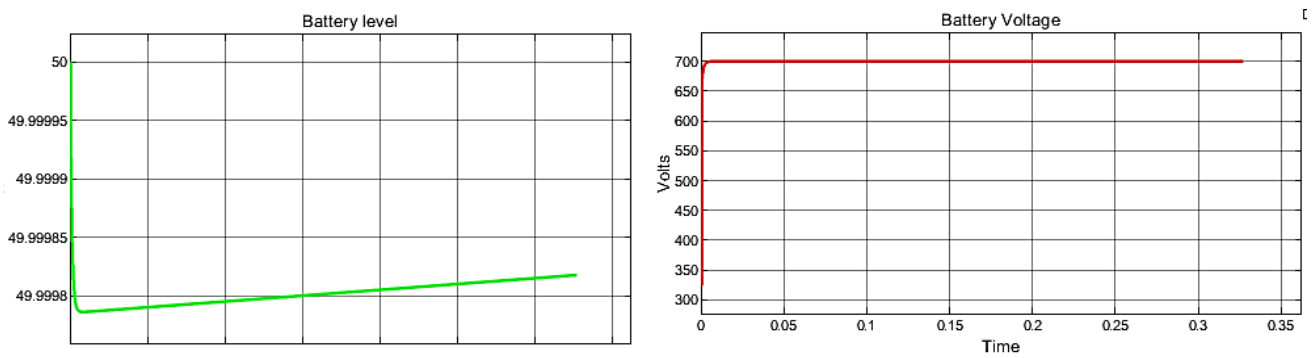

Figure 4.3 Battery level and voltage of the scenario -1

4.1.2 Scenario-2

Only Solar Power Source available: Solar power is available and supplying the total load while both wind and grid power are unavailable or isolated. Additionally, the battery is being charged using the surplus solar power.

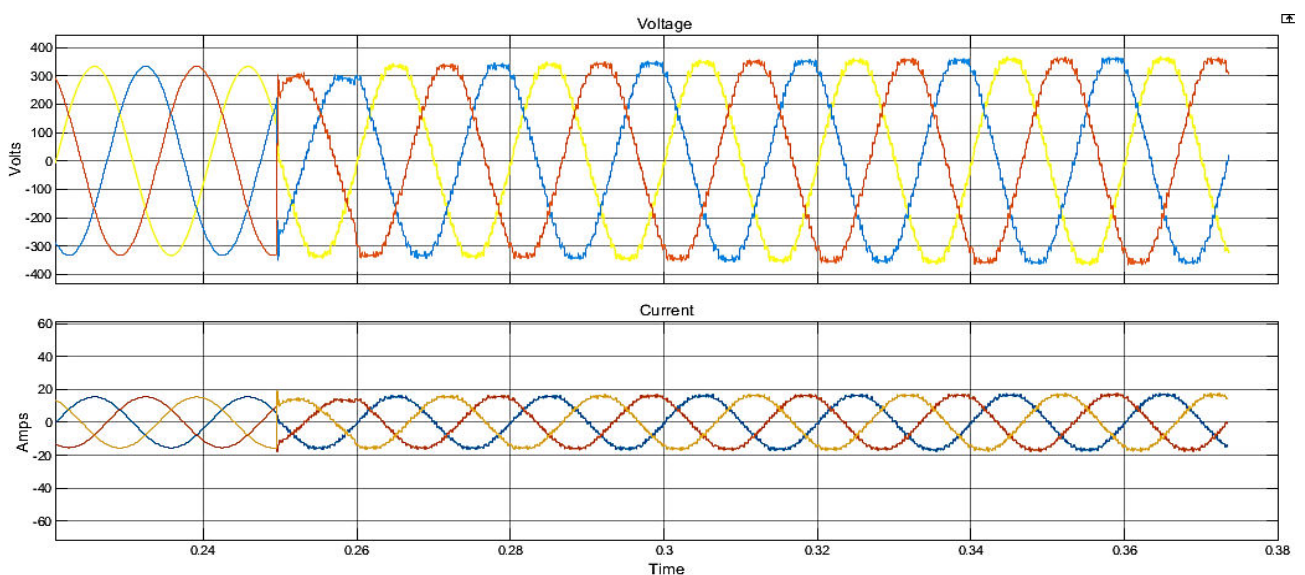

Figure 4.4 Output Voltage and Current of scenario – 2

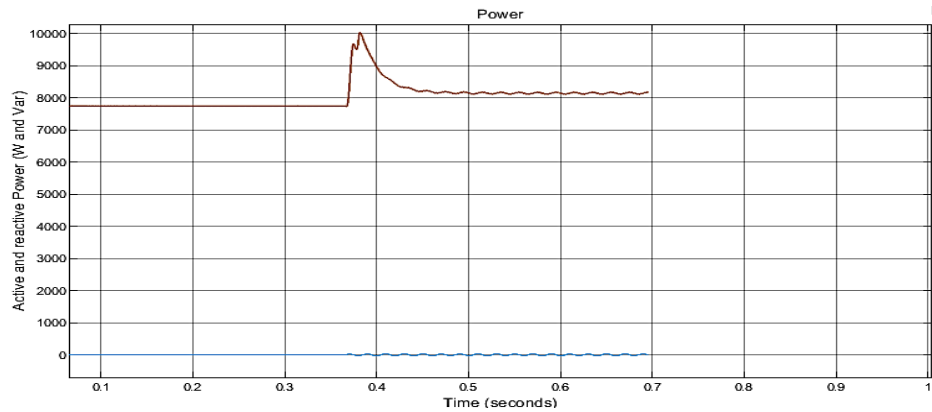

Figure 4.5 Output power of scenario – 2

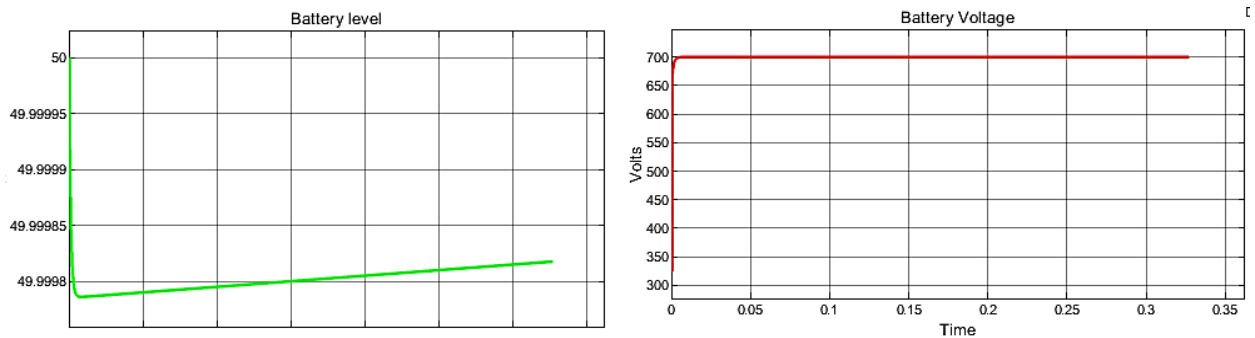

Figure 4.6 Battery level and voltage of the scenario -2

4.1.3 Scenario-3

Only Wind Power Source available: The wind power system is operational and supplies the total load demand. Simultaneously, the surplus wind power is utilized to charge the battery, while solar and grid power remain unavailable or isolated.

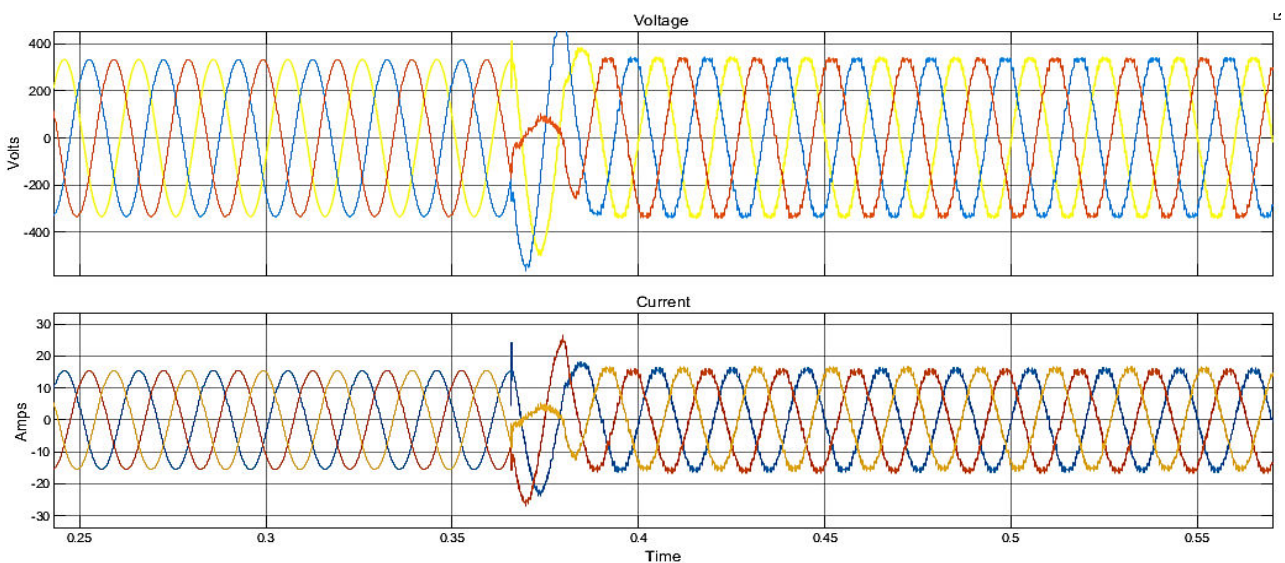

Figure 4.7 Output Voltage and Current of scenario – 3

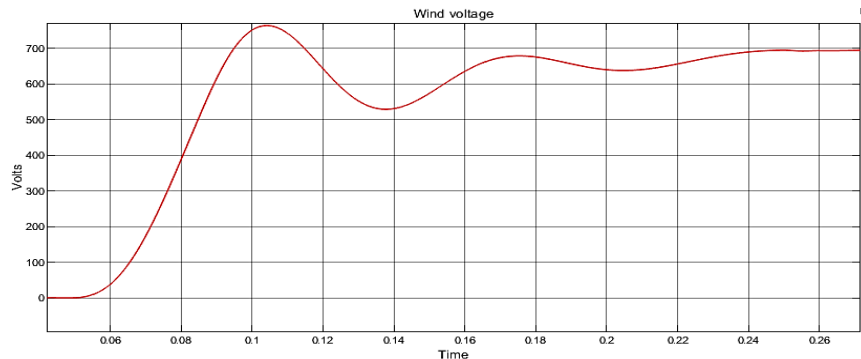

Figure 4.8 Output Voltage variation of wind

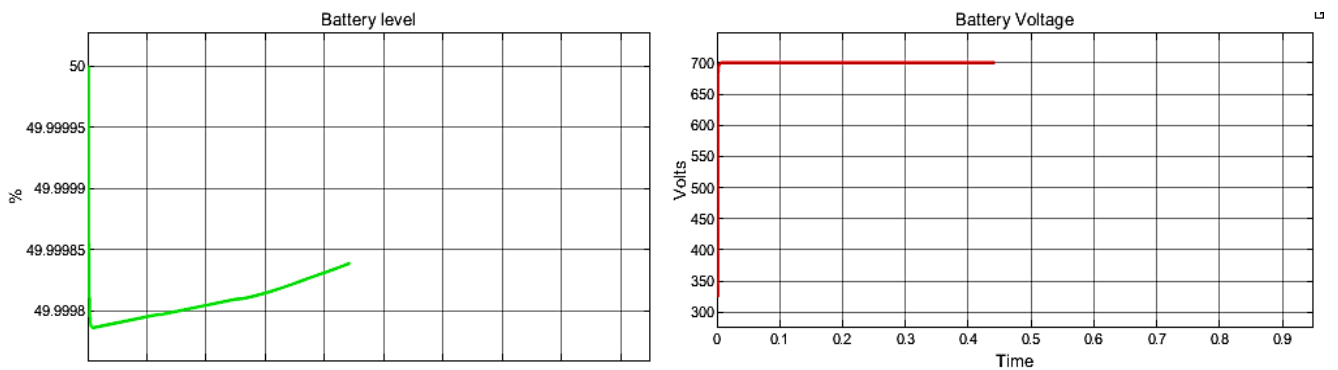

Figure 4.9 Battery level and voltage of the scenario – 3

4.1.4 Scenario-4

Solar + Wind Power Source are available: Solar + Wind Power Source: Solar and wind power supply the total load while the system operates in isolated mode (grid unavailable). Excess energy from solar and wind sources is used to charge the battery.

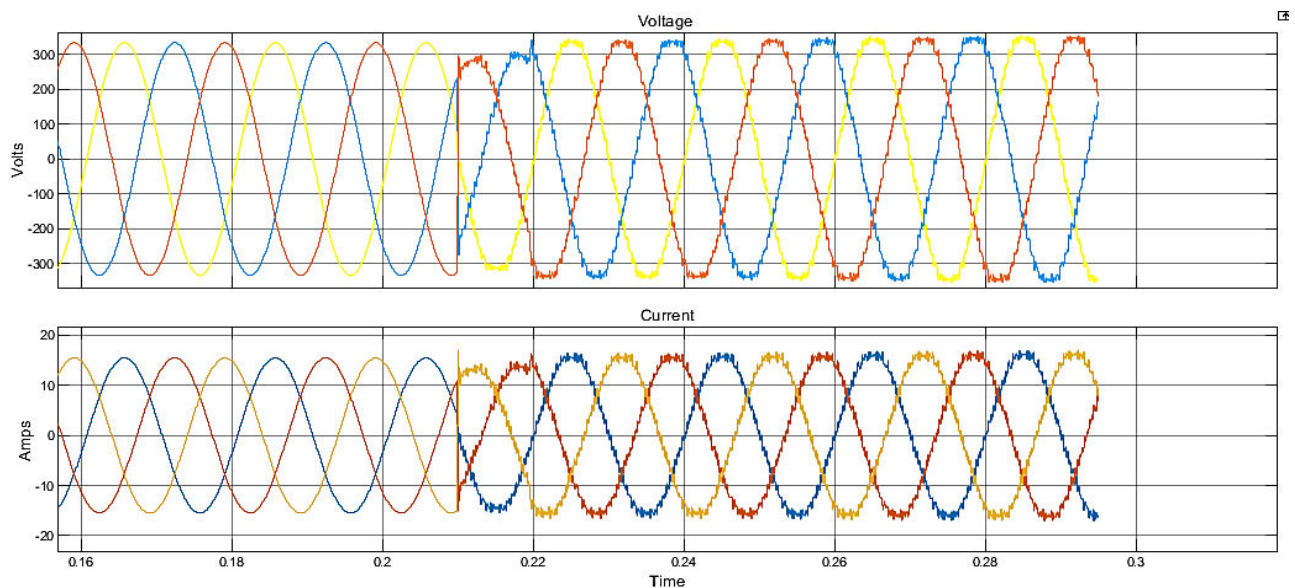

Figure 4.10 Output Voltage and Current of scenario – 4

4.1.5 Scenario-5

Solar to Wind or Wind to Solar Power changeover on different condition: When SOLAR fail to tackle the load WIND will be single handed tackle the load & whenever both fail GRID come to picture & tackle the load or vise-versa.

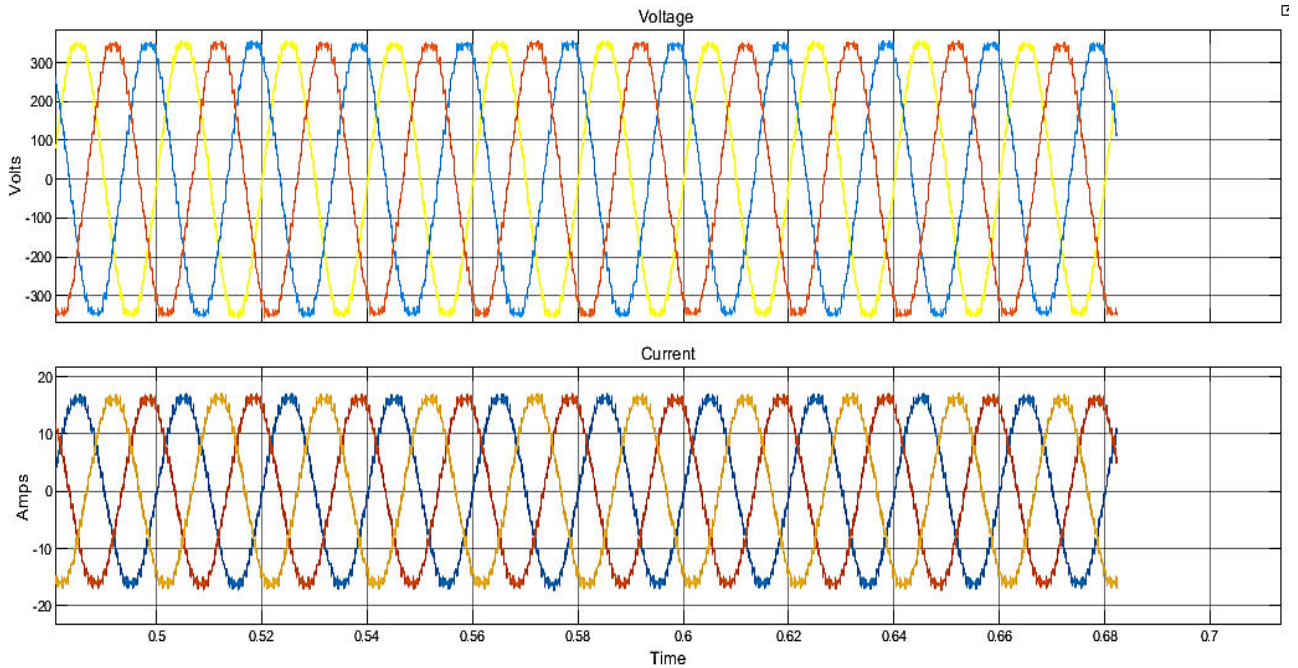

Figure 4.11 Output Voltage and Current of scenario – 5

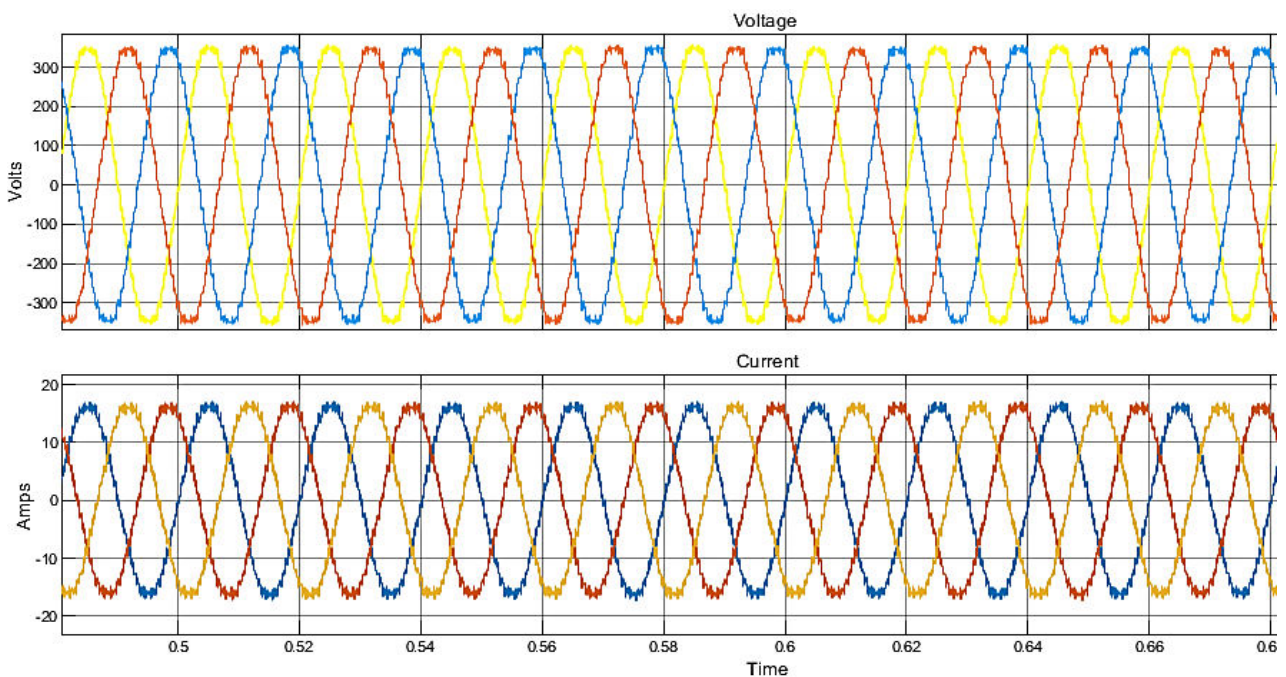

Figure 4.12 Output Voltage and Current of scenario – 5

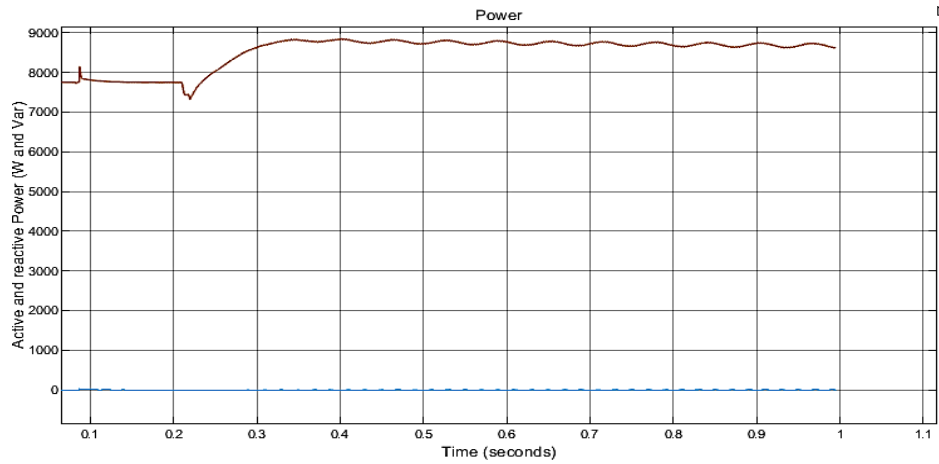

Figure 4.13 Output power of scenario – 5

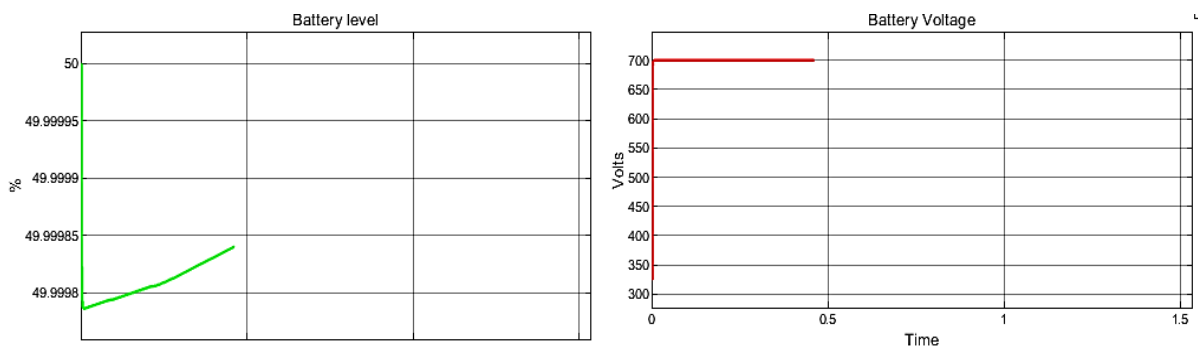

Figure 4.14 Battery level and voltage of the scenario – 5

4.1.6 Scenario-6

In the event of a complete failure of all primary power sources, such as solar, wind, and the grid, resulting in a blackout condition, the battery system becomes crucial. It takes over to provide power and support the total load for a limited duration, ensuring continuity of electricity supply until the primary sources are restored or alternative solutions are activated.

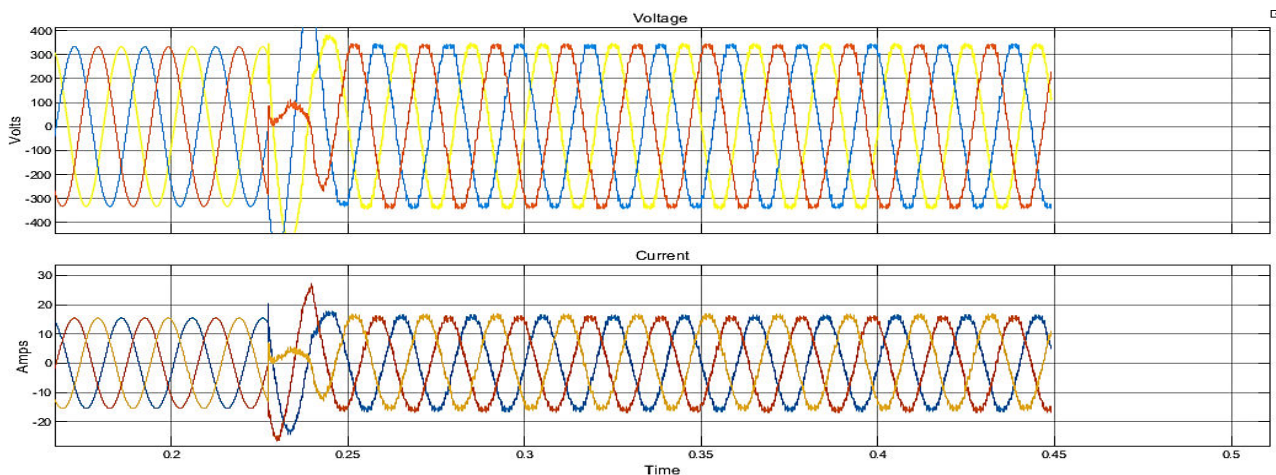

Figure 4.15 Output Voltage and Current of scenario – 6

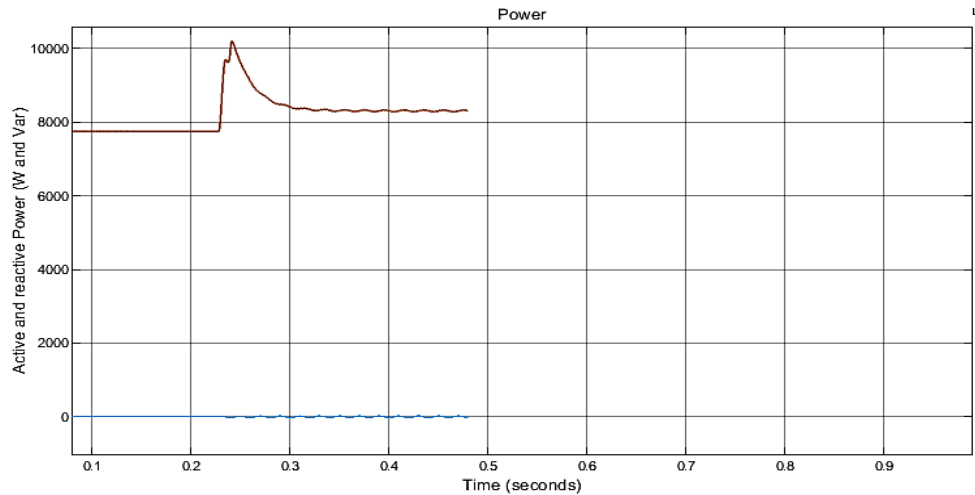

Figure 4.16 Output power of scenario – 6

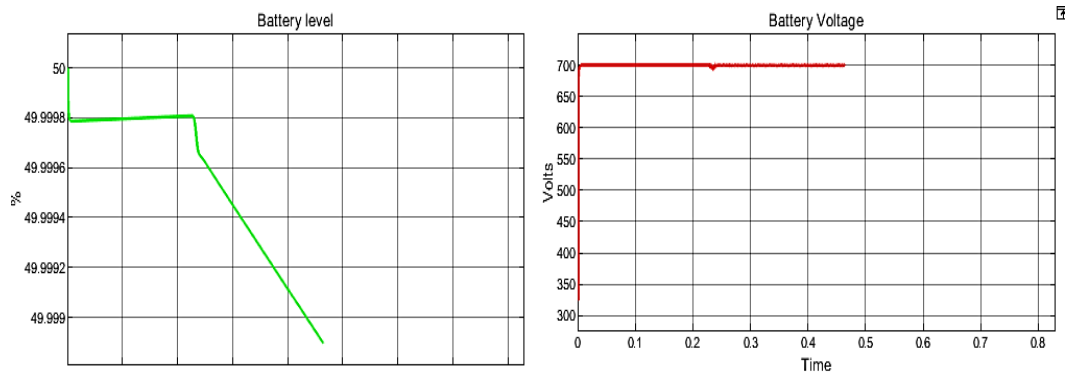

Figure 4.17 Battery level and voltage of the scenario – 6

V.CONCLUSION

The "Renewable Energy-Based Microgrid Energy Management System" demonstrates the transformative potential of integrating solar, wind, and grid electricity to create a cost-effective and environmentally sustainable energy solution for residential applications. By leveraging advanced simulation techniques in MATLAB/Simulink, the project validates the economic and environmental advantages of adopting renewable energy in a residential microgrid setup. The significant reduction in electricity costs, combined with the increased reliance on renewable sources, underscores the feasibility of implementing such systems on a larger scale.

This project not only provides a blueprint for sustainable energy management in residential settings but also reinforces the importance of innovative energy solutions in addressing global challenges such as climate change and energy scarcity. By promoting the adoption of renewable energy and reducing carbon emissions, the proposed system aligns with the growing demand for sustainable living, paving the way for a greener and more economically viable future.

REFERENCES

- [1] A. Bouharchouche, E. M. Berkouk, and T. Ghennam, "Control and energy management of a grid connected hybrid energy system pv-wind with battery energy storage for residential applications," in 2021 Eighth International Conference and Exhibition on Ecological Vehicles and Renewable Energies (EVER), IEEE, 2022, pp. 1–11..
- [2] T. Bocklisch, "Hybrid energy storage systems for renewable energy applications," Energy Procedia, vol. 73, no. 2022, pp. 103–111, 2022.

- [3] B. Parida, S. Iniyar, and R. Goic, "A review of solar photovoltaic technologies," *Renewable and sustainable energy reviews*, vol. 15, no. 3, pp. 1625–1636, 2021.
- [4] A. Qazi, F. Hussain, N. A. Rahim, G. Hardaker, D. Alghazzawi, K. Shaban, and K. Haruna, "Towards sustainable energy: A systematic review of renewable energy sources, technologies, and public opinions," *IEEE Access*, vol. 7, 2022.
- [5] M. Agrawal, A. Mittal, "Micro Grid Technological Activities across the Globe: A Review", *International Journal of Research and Reviews in Applied Sciences*, Vol.7, Issue 2, May 2021.
- [6] L. Xu, D. Chen, "Control and Operation of a DC Microgrid with Variable Generation and Energy Storage", *IEEE Transactions on Power Delivery*, Vol.26, Issue 4, Oct 2021
- [7] K. Shivarama Krishna and K. Sathish Kumar, "A review on hybrid renewable energy systems," *Renewable & Sustainable Energy Reviews*, vol. 52, pp. 907-916, Dec. 2021.
- [8] Dr. Swapnil B. Mohod, V. R. Prihar and Sagar D. Nimkar, "Hybrid power system with integration of wind, battery and solar PV system", *IEEE International Conference on Power, Control, Signals and Instrumentation Engineering*, pp.2332-2337, September 2020.
- [9] Bashar, Abul, and S. Smys. "Integrated Renewable Energy System for Stand-Alone Operations with Optimal Load Dispatch Strategy." *Journal of Electronics*, vol. 3, no. 2, pp. 89-98, June 2021.
- [10] A. Mohapatra, S. Mohapatra and S. Naidu Bora, "Hybrid renewable energy system for real time power management techniques- a review", *IEEE International Symposium on Sustainable Energy, Signal Processing and Cyber Security*, pp. 1-6, February 2021.



INTERNATIONAL
STANDARD
SERIAL
NUMBER
INDIA



INTERNATIONAL JOURNAL OF INNOVATIVE RESEARCH

IN SCIENCE | ENGINEERING | TECHNOLOGY

 9940 572 462  6381 907 438  ijirset@gmail.com



www.ijirset.com

Scan to save the contact details