



# International Journal of Innovative Research in Science Engineering and Technology (IJIRSET)

*(A Monthly, Peer Reviewed, Refereed, Scholarly Indexed, Open Access Journal)*



**Impact Factor: 8.699**

**Volume 14, Issue 3, March 2025**

# **Seismic Effect on Re Entrant Corner with % Diaphragm Opening in a Building and Combination of Both**

**Mohammad Shadab Khan, Dr N.G Gore**

P.G. Student, Department of Civil Engineering, M.G.M.'S College of Engineering and Technology, Navi Mumbai,  
Maharashtra, India

Professor, Department of Civil Engineering, M.G.M.'S College of Engineering and Technology, Navi Mumbai,  
Maharashtra, India

**ABSTRACT:** Seismic vulnerability of India states that there are about 11 million seismically vulnerable houses in zone V and 50 million in zone IV. There about 80 million houses overall which are vulnerable to seismic activity. Past earthquake experiences demonstrate the fact that buildings with rectangular plan or box type buildings perform well than buildings with irregular shaped plans. During Bhuj (2001) earthquake majority of the buildings damages were not designed for seismic loading and most of the buildings were not engineered. It also implicates that irregular buildings are undesirable as they do not possess sufficient seismic resistance. Hence, it is necessary that all buildings be designed for seismic loading and irregular configuration must be avoided. this study is about the seismic response of reinforced concrete structures having combination of two plan irregularities, re-entrant corner and diaphragm discontinuity buildings. Study is performed combining this two plan irregularity criteria and analyzing the results in seismic zone ,3,4 and 5. For this 1 is regular building, 3 re-entrant corner buildings with three variations in A/L ratio, three buildings with opening in diaphragm with three varying percentage of opening. 9 structures are made combining these buildings with the combination of two irregularities. Structures are analyzed in etabs software by response spectrum analysis. Parameters such as story displacement, story drift, base shear, overturning moments are determined .

**KEYWORDS:** Re-entrant corner, diaphragm discontinuity, combination of both, response spectrum, displacement, drift, base shear, overturning moment

## **I. INTRODUCTION**

Any structure is considered as irregular if there is a variation in the distribution of mass or stiffness or both. A regular structure has no such significant variation and hence, their seismic behaviour is more predictable and favourable. However, in case of irregular structure they undergo complex, unacceptable seismic behaviour making the structural response difficult to predict. Hence, there is a need for extensive study in understanding their response to seismic loading. There are two types of structural irregularities, namely:

**Vertical irregularity:** The uneven distribution of mass, strength or stiffness along the height of the building results in vertical irregularity.

**Plan irregularity:** This arises due to discontinuity in mass, stiffness or strength along the plan of the building. Hence, it is also termed as horizontal irregularity. Their seismic response is a combination of translation and torsion, which is due to stiffness and mass eccentricity in the structure.

Clause 7.1 Table 5 of IS 1893 (PART 1):2016.) Defines re-entrant corner as a location in a structure where in the projection of the building component beyond that point exceeds 15% of its plan dimension in the given direction. When the building is subjected to ground motion inertial forces are mobilized. These forces travel along different paths known as „load paths“ through various structural components and finally being transferred to the soil through foundation. In case of buildings with re-entrant corners, the shape of the plan is such that it necessitates indirect load paths which lead to local stress concentration at point where load path bends. Re-entrant corners in a building pose two major serious threats. Firstly, they cause differential motions in different wings of the building due to variation in rigidity leading to

local stress concentration at the notch of the re-entrant corner. On the other hand, they induce significant torsion in a building.

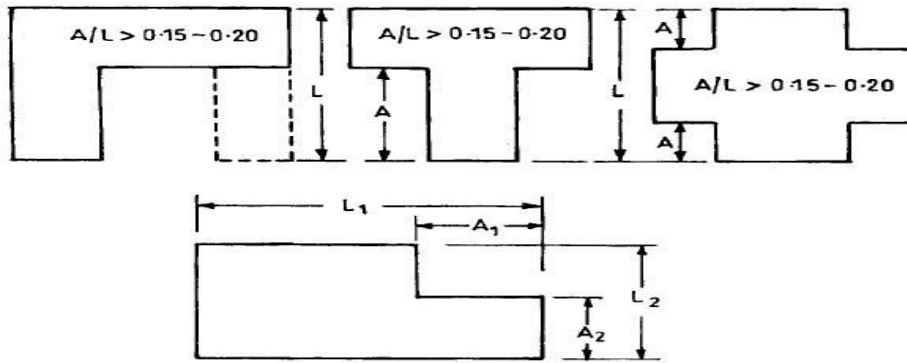

Re-entrant corners showing computation of A/L ratio. IS Code fig 3B (1.10):

Table 1.1 classifications of re-entrant corners based on A/L ratio

| A/L Ratio   | Condition        |
|-------------|------------------|
| <0.15       | Safe             |
| 0.15 – 0.20 | Deficient        |
| >0.20       | Highly deficient |

• Floor slabs having excessive cut-outs or openings: - A building is said to have discontinuity in their in-plane stiffness, when floor slabs have cut-outs or openings of area more than 50 percent of the full area of the floor slab.

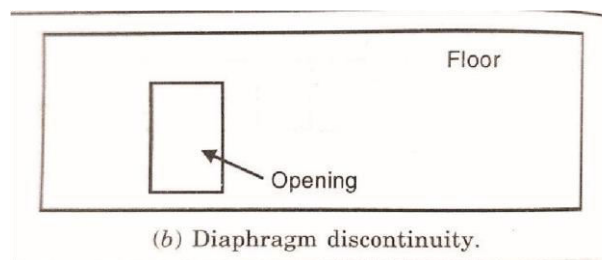

• Out-of-plane offsets in vertical elements resisting lateral loads cause discontinuity and detours in the load path, which is known to be detrimental to the earthquake safety of the building. A building is said to have out of plane offset in vertical elements, when structural walls or frames are moved out of plane in any story along the height of the building.

## II. LITERATURE SURVEY

**Rakesh Sakale, R K Arora et al. (2014)** : This paper is the study of seismic behaviour of horizontally irregular buildings with regular building. L-shape, T-shape, C-shape and regular shape buildings of equal height are taken and lateral displacement and story drift are derived after analysis. Results were compared and studied. Analysis is performed in staad pro. For seismic zone II, III, IV, and V. Results were such that from drift point of view for zone II TO IV all frames are within permissible limit and there is no need to provide shear wall. Only with the building with plan C exceeds the permissible limit and may require shear wall. For displacement point of view, all buildings are within permissible limit

only for zone II. In zone III and above regular plan building slightly exceeds the permissible limit but other requires shear wall to control the limit.

**Komal R. Bele1, S. B. Borghate (2015) :** This paper is focused on buildings with large projections of Re-entrant corners results in torsion. He took four models one regular and other 3 with varying projections. The conclusion of this paper was base shear decreases from Model R to L5 (decreases with increase in projection). He also concluded that as projection of increases there are more coupling of modes. Result obtained shows that forces in column (common in all building) shows that the variation of P much higher with increase in projection.

**Babita Elizabeth baby and shreeja s (2015) :** This paper is on the study of slab discontinuity at different position that is at the centre, at corners, and at periphery. Pushover analysis are performed in etabs software. Results were that the axial forces, bending moment and story drift are more effectively resisted by the model having slab opening in periphery. So, the opening is more effective to be located at periphery.

**Md. Mahmud sazzad, Md. Samdani azad (2015) :** He conducted numerical study on the response of different shapes of building on various wind and earthquake zones. So for this he took three different shapes of the building subjected to lateral forces wind load and earthquake load and comparison of the results are presented in the paper. Computer aided analysis are performed for all structures. He concluded that L-shape building shows max. displacement due to earthquake along y direction. This is due to the distribution of seismic force depends upon stiffness. Story drift is max. along y-direction for earthquake and in x- direction for wind load.

**Atul Patane, Sachin Kadam (2015) :** He studied the seismic behaviour of plan irregular building configuration plan with regular model. He analysed G+9 story building in sap 2000 by response spectrum method. He concluded that a regular general configuration building is more stable in seismic effect than an unsymmetrical irregular building. **Milind V. Mohod (2015) :** This paper presents effects of plan and shape configuration on irregular shaped structures. For he took regular building plan, H shape plan, L shape plan, plus shape, E shape building shape, C shape and two of varying percentage of diaphragm plan for analysis. Buildings were designed in Staad pro software having G+ 11 floors. His results were in the form of drift and displacement. He concluded that re-entrant corner buildings show more displacement than diaphragm discontinuity irregular buildings. Drift is within permissible limit but L and C shows maximum drift.

**OBJECTIVE OF STUDY:** To study the seismic performance of RC frames with re-entrant corner and diaphragm discontinuities in III,IV,V seismic zones for varying soil site conditions. To compare the difference in behaviour of the models before and after in terms of capacity and performance. To investigate the seismic performance of a RC frame structure building with varying in % in X & Y direction re-entrant corner & diaphragm discontinuities using Response Spectrum analysis.

### III. METHODOLOGY

Aim of this study is to study the seismic behaviour of re-entrant corner RC building with opening in diaphragm. Total of 10 RC building models are taken.

(A).Each building has a common property as stated below –

For study purpose, the layout of the plan has 5 X 5 bays of equal length of 5m.

Building parameters are as follows –

- Type of building: SMRF (Clause 7.2.6 table no 9 IS 1893 (Part 1):2016.
- Numbers of story: G+15
- Height of Building: (45m)
- Seismic zone: III, IV and V (Clause 6.4.2 table 3 IS 1893 (Part 1):2016.
- Floor height: 3m
- Grade of concrete: M40
- Grade of steel: Fe550
- Beam dimension: 400 x 700mm
- Column dimension: 400 x 750mm
- Slab depth: 175mm
- Super imposed load :1.5 KN/m<sup>2</sup>

Mortar screeding – 0.21 x 2 (IS 875 PART 1 table 2 page 31)  
 Clay floor tiles – 0.10 (Clause 1.1 IS 875 Part 1 table 2 page 30)

- Live load on floor: 2.5 KN/m<sup>2</sup> (IS 875 PART 2 table 1)
- Masonry load: 4.59 KN/m (outer wall) [(0.30 (t) x 2.55 (h) x 6 (unit wt.))]  
 3.519 KN/m (inner wall) [(0.30 (t) x 2.55 (h) x 6 (unit wt.))]  
 [AAC (Autoclaved Aerated Concrete Block) is used.]  
 (unit weight of AAC blocks – 6 KN/m<sup>3</sup>)
- Importance factor: 1
- Response reduction factor: 5 .
- Soil type: II (medium)
- % imposed load: 25% of Live Load .
- Time period: 0.7s {0.09h /√d}.
- (B).G+14 story, 10 buildings are taken with 1 regular plan, 3 with varying re-entrant corner plan, 3 with varying opening in diaphragm, 3 with the combination of varying re-entrant corner and opening slab.
- (C). Modelling and analysis are done as per IS 1893 part 1 by response spectrum method in etabs software for zone IV and V.
- (D). Parameters such as base shear, max. story displacement, max. story drift, overturning moment are plotted in forms of tables and then graphs.
- (E)results are collated with regular building models.



Fig. 1: MODEL R-REGULAR

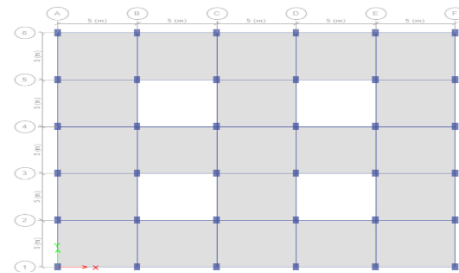

Fig. 2: MODEL DD1 (16% OPENING)

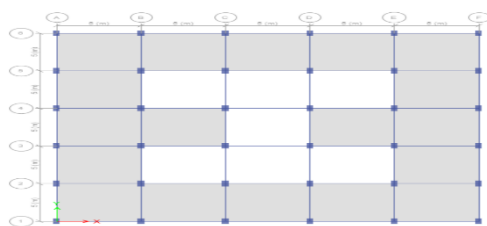

Fig. 3: MODEL DD2 (28% OPENING)

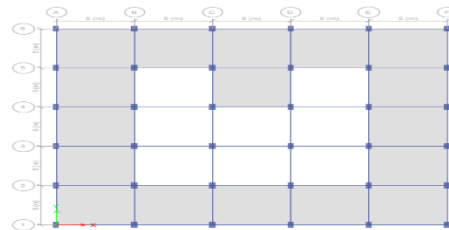

Fig. 4: MODEL DD3 (32% OPENING)

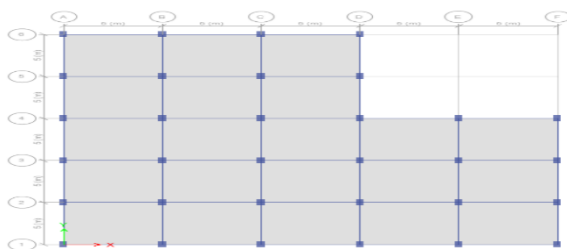

Fig. 5: MODEL RE1 (RE ENTRANT CORNERS 40% IN X & 40% IN Y)

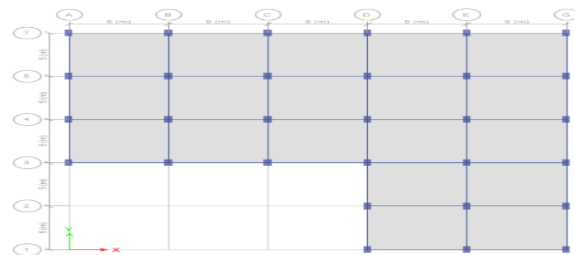

Fig. 6: MODEL RE2 (RE ENTRANT CORNER 60% IN X & AND 40% IN Y)

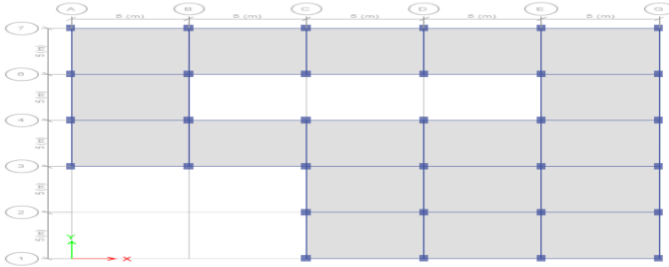

Fig 8: MODEL RD1(Re entrant 40% & OPENING with 12%)

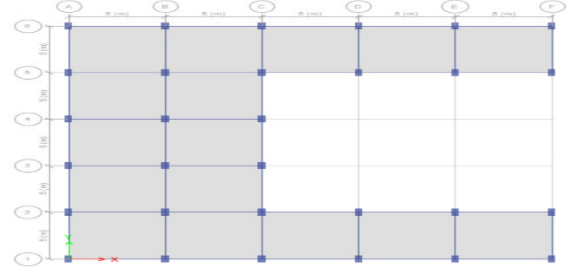

Fig 7: MODEL RE3 (RE ENTRANT CORNER 60% IN X & 60% IN Y )

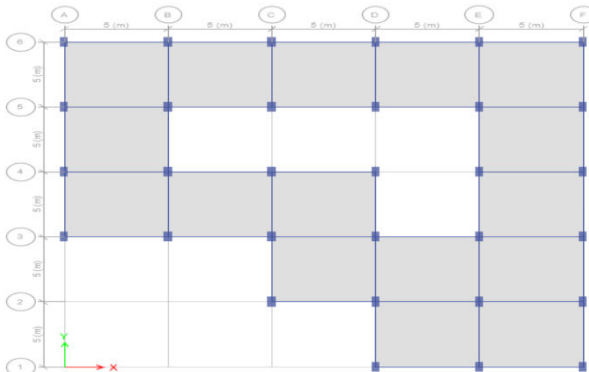

Fig 9: MODEL RD2(Re entrant 60% x 40% Y & opening with 16%)

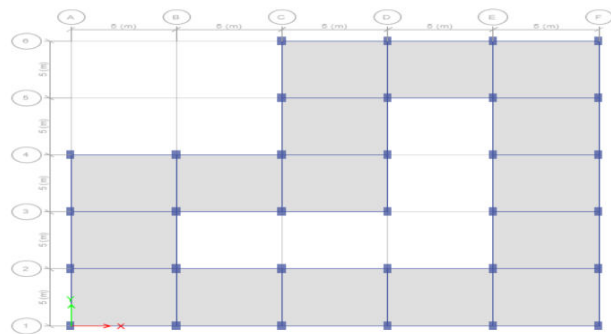

Fig 10: MODEL RD3(Re entrant 40% & with opening 20%)

#### IV. EXPERIMENTAL RESULTS

##### RESULTS AND DISCUSSION

##### RESULTS IN TABULAR FORM

BAR GRAPH REPRESENT MAXIMUM VALUE FOR DIFFERENT ZONE

##### ZONE III (RS DISPLACEMENT IN X DIRECTION)

| STOREY    | R     | D1     | D2     | D3     | R1     | R2     | R3     | DR1    | DR2    | DR3    |
|-----------|-------|--------|--------|--------|--------|--------|--------|--------|--------|--------|
| Storey 15 | 24.56 | 24.195 | 24.246 | 26.862 | 30.161 | 22.589 | 24.115 | 25.854 | 28.459 | 25.889 |

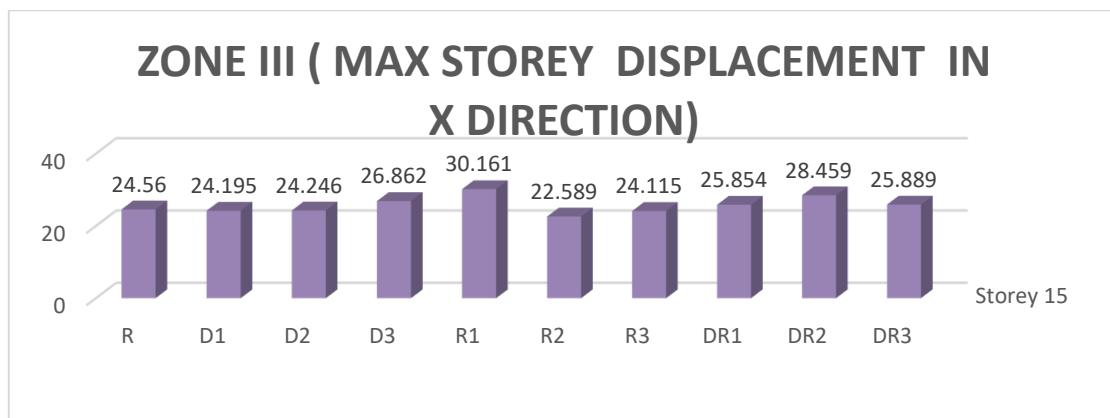

**ZONE III (RS DRIFT IN X DIRECTION)**

| STORE Y  | R        | D1       | D2       | D3      | R1       | R2       | R3       | DR1      | DR2      | DR3     |
|----------|----------|----------|----------|---------|----------|----------|----------|----------|----------|---------|
| Storey 1 | 0.000878 | 0.000864 | 0.000816 | 0.00089 | 0.001267 | 0.000788 | 0.000832 | 0.000904 | 0.000956 | 0.00083 |

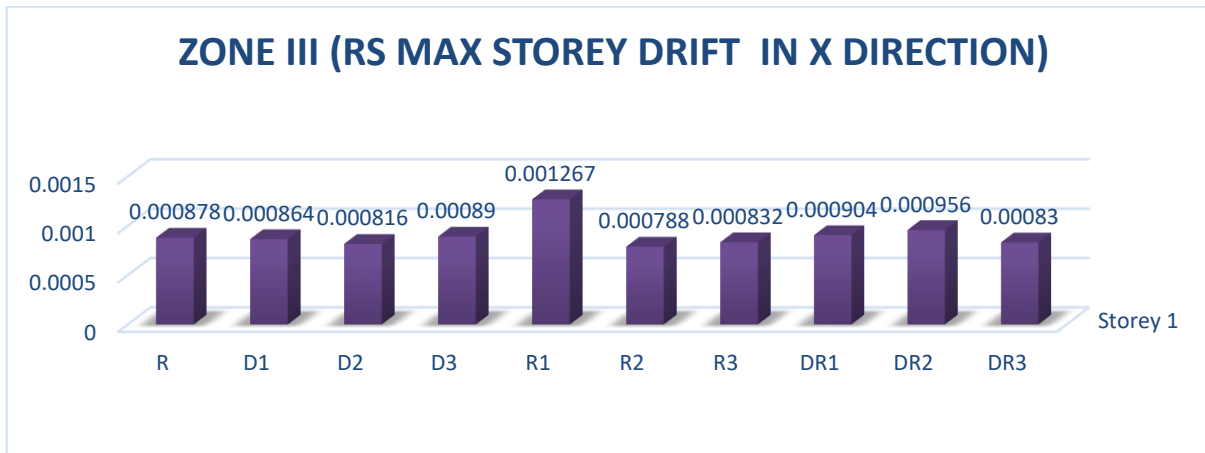

**ZONE III (RS OVERTURNING IN X DIRECTION)**

| STORE Y | R        | D1       | D2       | D3       | R1       | R2       | R3       | DR1      | DR2      | DR3      |
|---------|----------|----------|----------|----------|----------|----------|----------|----------|----------|----------|
| BASE    | 4171.266 | 4079.685 | 3808.889 | 3741.774 | 2915.144 | 3037.575 | 3175.913 | 3431.449 | 3640.923 | 3321.342 |

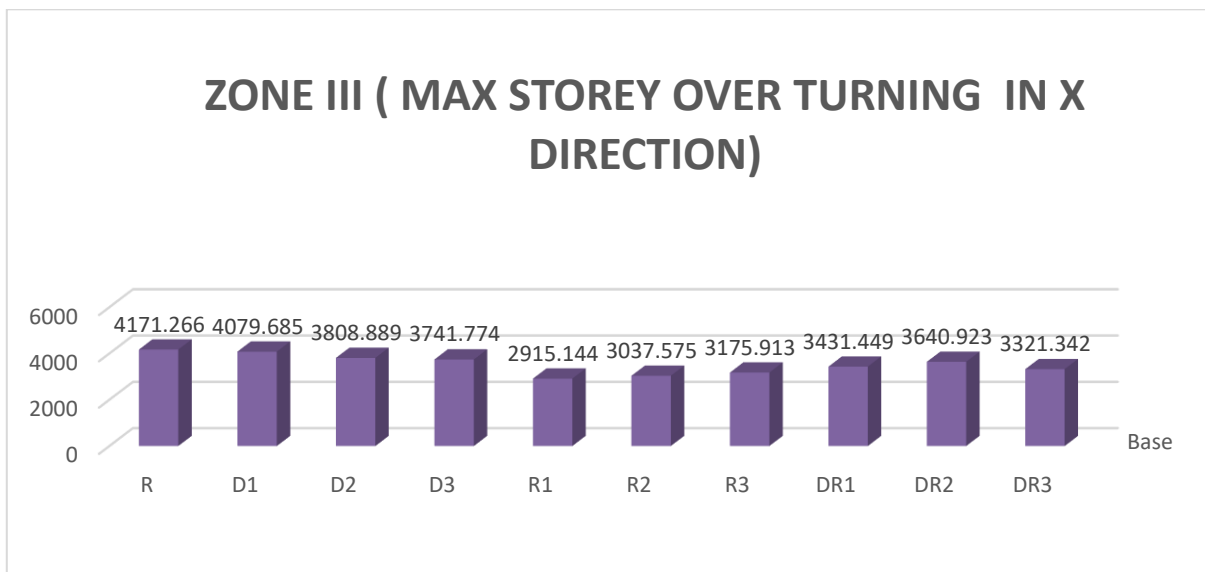

**V. CONCLUSION**

Seismic response of plan regular & irregular building in three different zones III, IV and V are studied. After the study results obtained from the analysis of different structure, following conclusion can be made

1. For max. displacement model DR2 & R1 shows maximum for zones III. And Model R2 shows the least displacement in all zone. By this we can say that diaphragm opening not much effect the displacement but re-entrants do. And combination of both makes structure more unstable.
2. When it comes to story drift from results, we can see that more percentage of opening less drift value For all zone and for 40% of re-entrant in both direction we can see more drift in III zone & more varying percentage re-entrant less drift. Therefore, when it comes to the combination of two models R1 & DR2 shows max. drift for III zones.
3. Models R shows max. overturning moment and as opening in slabs increases it reduces. Similarly, it is for re-entrant corner models as the more varying percentage it increases. But for the combination of two irregularity model DR1,DR2 there is an increase in overturning moment as varying percentage increases. And Model with re-entrant corner show less overturning more varying percentage re-entrant more overturning. Hence, we can say that the lesser the re-entrant corner results in less overturning moment.

**REFERENCES**

1. Indian Standard code of practice for plain and reinforced concrete structures 456: 2000
2. Indian Standard code for Earthquake resistant design structures 1893 Part I: 2016
3. Indian Standard code for design loads 875 Part I and Part II
4. Komal R. Bele<sup>1</sup>, S. B. Borghate (2015) “*Dynamic Analysis of Building with Plan Irregularity*”, Journal of Civil Engineering and Environmental Technology, ISSN: 2349-8404, Volume 2, April – June, 2015
5. Babita Elizabeth baby and shreeja s (2015) “*Analysis of building with slab discontinuity*” international journal of science and research. ISSN: 2319-7064, volume 5 issue 9, September 2016.
6. Kazi Muhammed mustaqeem and md mansoor ahmad (2016) “*Impact of intermittent diaphragm and re-entrant corners on seismic response of multistoried RC framed buildings*” international journal of engineering research and technology. ISSN: 2278-0181, vol. 5 issue 07, July-2016
7. Subodh.S.Patil and Shrinivas.R.Survanshi “*A Study of Plan Irregularity Inducing Accidental Torsional Moment of Multi Story Building using Stadd Pro*”, International Journal of Current Engineering and Technology, E-ISSN 2277 – 4106, P-ISSN 2347 –
8. Reena sahu and Ravi dwivedi,” *Seismic analysis of RC frame with diaphragm discontinuity*” IOSR journals of mechanical and civil engineering. ISSN: 2320-334X, volume 14, July 2017.
9. Lohith kumar B C and Babu abera areda, “*Seismic effect of re-entrant and torsional irregularities on multi-story buildings*”, international research journal of engineering and technology, ISSN: 2395-0056, volume 4, April 2017.
10. Akshay Nagpure<sup>1</sup>, S. S. Sanghai (2018) “*Effect of Diaphragm Flexibility on the Seismic Response of RCC Framed Building Considering Diaphragm Discontinuity*”, International Journal of Innovations in Engineering and Science, Vol. 3, No.5, 2018 www.ijies.net
11. Sanjay Naik, Thushar S Shetty, “*Comparison of Rectangular shape, L shape and C shape Multistory Structure Under the Effects of Earthquake*”, International Advance Journal of Engineering Research, ISSN: 2360-819X, Volume 2, Issue 5 (May- 2019).





INTERNATIONAL  
STANDARD  
SERIAL  
NUMBER  
INDIA



# INTERNATIONAL JOURNAL OF INNOVATIVE RESEARCH

IN SCIENCE | ENGINEERING | TECHNOLOGY

 9940 572 462  6381 907 438  [ijirset@gmail.com](mailto:ijirset@gmail.com)



[www.ijirset.com](http://www.ijirset.com)

Scan to save the contact details